

*Alias*

general  
catalogue



# *Alias*

## timeless design

Alias aim is to create long-lasting products. Timeless design defines the spirit of the brand in the development of its collection. It is the way in which the different pieces of furniture are conceived and designed, and embodies the true beauty of 'timeless' design. Our mission is to constantly develop design innovation through the research of sustainable materials and the employment of innovative technologies with a focus on design quality.

Alias lavora per creare prodotti che durino nel tempo. Timeless design definisce lo spirito del brand nello sviluppo della sua collezione. È il modo in cui vengono concepiti e progettati i diversi arredi ed incarna la vera bellezza del design "senza tempo". La nostra missione è sviluppare in modo costante l'innovazione di design attraverso ricerche di materiali sostenibili e l'utilizzo di tecnologie innovative, con un'attenzione particolare alla qualità del progetto.

Alias arbeitet daran, Produkte zu schaffen, die lange halten. Timeless Design definiert den Geist der Marke bei der Entwicklung ihrer Kollektionen. Das ist der Weg in dem die verschiedenen Einrichtungsgegenstände konzipiert und gestaltet sind, und verkörpert die wahre Schönheit des "zeitlosen" Designs. Unser Ziel ist die ständige Weiterentwicklung Designinnovation durch Forschung zu nachhaltigen Materialien und der Einsatz innovativer Technologien, mit Schwerpunkt auf der Projektqualität.

Alias travaille pour créer des produits qui durent dans le temps. Timeless design définit l'esprit de la marque dans le développement de sa collection. C'est la façon dont les différents meubles sont conçus et dessinés, et qui incarne la véritable beauté d'un design "intemporel". Notre mission consiste à développer en permanence l'innovation en matière de conception grâce à la recherche de matériaux durables et l'utilisation de technologies innovantes, avec une attention particulière à la qualité du projet.

# technology, research and quality

Each product by Alias is the expression of incessant research in the realm of materials and designs offering aesthetic and functional excellence. Through a process that combines innovation and tradition, Alias produces furnishing complements featuring highly refined and unprecedented styling. Every product is developed within a quality system that conforms to the UNI EN 9001 standard. The quality of Alias products is attested by the numerous certifications obtained through the years, that enable the company to bid for contract furniture projects on many markets characterised by a growing awareness of safety, health and environmental issues.

Alias is part of Fondazione Altgamma, which since 1992 has brought together companies of the Italian high cultural and creative industry, recognized as authentic ambassadors of the Italian style in the world. The Members are the heart of Fondazione Altgamma, their Brands stand out for innovation, top quality, service, design and express Italian culture and lifestyle.

Ogni prodotto Alias è espressione di una costante ricerca materica e produttiva, in grado di offrire eccellenza estetica e funzionale. Attraverso un processo che unisce innovazione e tradizione, Alias produce complementi d'arredo dal design ricercato ed inedito. Ogni prodotto è realizzato all'interno di un sistema di qualità rispondente alla norma UNI EN 9001. La qualità è testimoniata dal conseguimento negli anni di numerose certificazioni, che permettono di competere nei progetti contract di molti mercati, sempre più sensibili alle tematiche della sicurezza, della salute e dell'ambiente.

Alias fa parte di Fondazione Altgamma che dal 1992 riunisce le imprese dell'alta industria culturale e creativa italiana, riconosciute come autentiche ambasciatrici dello stile italiano nel mondo. I Soci sono il cuore di Fondazione Altgamma, i loro Brand si distinguono per innovazione, qualità, servizio, design ed esprimono la cultura e lo stile di vita italiani.

Jedes Produkt von Alias ist Ausdruck einer konstanten Recherchearbeit in den Bereichen Material und Produktion und bietet hochwertige Ästhetik und Funktionalität. Im Zuge eines Prozesses, der Innovation und Tradition miteinander vereint, produziert Alias Einrichtungsgegenstände mit einem ausgesuchten und neuen Design. Jedes Produkt wird innerhalb eines Qualitätssystems entsprechend der Norm UNI EN 9001 entwickelt. Die Qualität wird von den zahlreichen, im Verlauf der Zeit erlangten Zertifikaten belegt, die es ermöglichen, sich bei Contract-Projekten im Wettbewerb vieler Märkte zu behaupten, auf denen die Anforderungen an Sicherheit, Gesundheit und Umweltschutz eine zunehmend große Rolle spielen.

Alias ist Teil der Fondazione Altgamma, das seit 1992 Unternehmen des italienischen Hochkultur- und Kreativwirtschaft zusammenbringt, die als authentische Botschafter des italienischen Stils in der Welt anerkannt sind. Die Mitglieder sind das Herzstück der Fondazione Altgamma, ihre Marken zeichnen sich durch Innovation, Qualität, Dienstleistung, Design aus und sind Ausdruck italienischer Kultur und Lebensart.

Chacun des articles Alias est l'aboutissement d'une recherche constante en termes de matériaux et de fabrication rimant avec excellence esthétique et fonctionnelle. Grâce à un processus qui conjugue innovation et tradition, Alias produit des compléments d'ameublement au design sophistiqué et inédit. Chaque produit est réalisé dans une filière de qualité conforme à la norme UNI EN 9001. Au fil des ans, les nombreuses certifications obtenues témoignent de la qualité des articles et permettent à Alias de concurrencer les projets pour les collectivités sur de nombreux marchés, toujours plus à l'écoute de la sécurité, de la santé et de l'écologie.

Alias fait partie de Fondazione Altgamma qui, depuis 1992, réunit les entreprises de la haute industrie culturelle et créative italienne, reconnues comme d'authentiques ambassadrices du style italien dans le monde. Les Membres sont le cœur de Fondazione Altgamma, leurs Marques se distinguent par l'innovation, la qualité, le service, le design et expriment la culture et le style de vie italiens.



Fondazione  
Altgamma

ADIMEMBER

# Alias thinks sustainable

Alias works to create environmentally sustainable products, minimizing environmental impact through policies that involve every stage of its operations. The commitment to the environment is demonstrated by the continuous search of solutions in the context of ecological thinking, at all stages of the production chain. Certifications are important for Alias, which over the years has achieved the GREENGUARD®, which certifies products for indoor air quality, for the frame collection by Alberto Meda and the slim collection by PersonLloyd; and the FSC®, which identifies products made of wood from forests that are properly managed respecting ecosystems, animals and the people who depend on them. Alias manufactures some products with FSC®-certified wood on request, such as the outdoor collection *tech wood* by Alberto Meda in heat-treated ash wood and a selection of chairs with legs in solid wood, including *segesta wood* by Alfredo Häberli and *slim chair wood* by PearsonLloyd. To protect the environment, the 'zero kilometre' production: all Alias products in fact are made in Italy, by suppliers located within a radius of 50 km from the company's site in Grumello del Monte.

Alias lavora per creare prodotti eco-sostenibili, minimizzando l'impatto ambientale attraverso politiche che coinvolgono ogni fase del suo operato. L'impegno per l'ambiente è dimostrato dalla ricerca continua di soluzioni nel contesto del pensiero ecologico, in tutte le fasi della filiera produttiva.

Le certificazioni sono importanti per Alias che negli anni ha conseguito la GREENGUARD®, che certifica i prodotti per la qualità dell'aria interna, per la collezione *frame* di Alberto Meda e la collezione *slim* di PersonLloyd; e la FSC®, che identifica i prodotti in legno proveniente da foreste gestite in modo corretto nel rispetto degli ecosistemi, degli animali e delle persone che da esse dipendono. Alias realizza su richiesta, con legno certificato FSC®, la collezione da esterno in frassino termotrattato *tech wood* di Alberto Meda e una selezione di sedute con gambe in massello, tra le quali *segesta wood* di Alfredo Häberli e *slim chair wood* di PearsonLloyd. A tutela dell'ambiente la produzione a "chilometro zero": tutti i prodotti Alias sono infatti realizzati in Italia, presso fornitori situati nel raggio di 50 km rispetto alla sede di Grumello del Monte (BG).

Alias setzt sich für die Herstellung ökologisch nachhaltiger Produkte ein, mit der Minimierung der Umweltauswirkungen durch eine Politik, die jede Phase seiner Tätigkeit einbezieht. Das Engagement für die Umwelt wird durch die kontinuierliche Suche von Lösungen im Kontext des ökologischen Denkens nachgewiesen, in allen Phasen der Produktionskette. Zertifizierungen sind wichtig für Alias, das im Laufe der Jahre das GREENGUARD®-Zertifikat für die Frame-Kollektion von Alberto Meda und die Slim-Kollektion von PersonLloyd erhalten hat, das Produkte für die Luftqualität in Innenräumen zertifiziert; und das FSC®, das die Produkte kennzeichnet, die aus Holz aus gut bewirtschafteten Wäldern gefertigt werden, die Ökosysteme, Tiere und die Menschen, die von ihnen abhängen, respektieren. Auf Anfrage stellt Alias Produkte mit FSC®-zertifiziertem Holz her, wie die Outdoor-Kollektion *tech wood* von Alberto Meda aus wärmebehandelter Esche und eine Auswahl von Stühlen mit Massivholzbeinen, darunter *Segesta wood* von Alfredo Häberli und *Slim chair wood* von PersonLloyd. Zum Schutz der Umwelt, die "Null-Kilometer"-Produktion: alle Alias-Produkte sind in Italien hergestellt, bei Lieferanten mit Sitz in einem Umkreis von 50 km Radius um den Hauptsitz des Unternehmens in Grumello del Monte (BG).

Alias s'efforce de créer des produits écologiquement durables, en minimisant l'impact sur l'environnement grâce à des politiques qui impliquent chaque étape de ses opérations. L'engagement en faveur de l'environnement se traduit par la recherche permanente de solutions dans le contexte de la pensée écologique, à toutes les étapes de la chaîne de production.

Les certifications sont importantes pour Alias qui, au fil des ans, a obtenu GREENGUARD®, qui certifie les produits pour la qualité de l'air intérieur, pour la collection *frame* d'Alberto Meda et la collection *slim* de PersonLloyd; et FSC®, qui identifie les produits en bois provenant de forêts gérées correctement dans le respect des écosystèmes, des animaux et des personnes qui en dépendent. Alias réalise sur demande, avec du bois certifié FSC®, la collection d'extérieur *tech wood* d'Alberto Meda et une sélection de sièges avec pieds en bois massif, parmi lesquels *segesta wood* d'Alfredo Häberli et *slim chair wood* de PearsonLloyd. Pour protéger l'environnement, la production à "kilomètre zéro" : tous les produits Alias sont en effet fabriqués en Italie, auprès de fournisseurs situés dans un rayon de 50 km autour du siège de Grumello del Monte (BG).



# transversality

Thanks to its characteristic cross-use, Alias design furniture is ideally suited for contract purposes in a variety of settings. This area of use proves equally congenial, thanks to its multifaceted aspects, to this increasingly broad-ranging, consistent and well-matched catalogue of products. Even outside the intimacy of the domestic setting, Alias collections confirm the natural ease with which they can be used to furnish any setting, whether public or private, large or small, outdoor or indoor.

Public spaces used as waiting areas, or exhibition centres, auditoriums, conference or meeting rooms, working offices, editorial departments, archives, libraries, places of worship, study rooms, sports facilities or theatres, retail outlets, exclusive restaurants and bars, areas dedicated to hospitality and wellbeing, nightclubs and fashion spots, collective and community spaces, venues used for fashionable events and parties: these are just some of the wide range of settings where Alias furniture can be used, with style and discretion, guaranteeing exceptional functionality and revealing characteristics that are immediately recognisable, anywhere.

Lightness of form is the silent charisma of Alias products, following an extremely simple and rigorous design. Every item is developed with the original formula that now makes the brand so distinctive and is based on the company's constant commitment to creative research and design, product quality, and the innovation of materials and production technologies.

Flanked by a solid production capacity, consistency of image and communication, marketing intuition and extensive experience of distribution. These choices have ensured the international success of Alias brand and enable the furniture to act as a genuine "passe-partout", in every setting, to the production of top quality design.

I pezzi di design Alias, grazie alla loro caratteristica trasversalità d'uso, rivelano in numerose occasioni una grande propensione al contract, un territorio d'impiego che, nei suoi molteplici aspetti, si dimostra altrettanto congeniale a questo sempre più ampio, coerente e omogeneo catalogo di prodotti. Anche quando escono dall'intimità delle pareti domestiche, le collezioni Alias riconfermano la loro naturale facilità ad arredare tutti gli ambienti, pubblici e privati, grandi e piccoli, esterni ed interni.

Spazi pubblici destinati all'attesa oppure ambienti espositivi, auditorium, sale per conferenze o per riunioni, uffici operativi, redazioni, archivi, biblioteche, luoghi per il culto, aule di studio, strutture per lo sport o lo spettacolo, punti vendita, indirizzi esclusivi della ristorazione, dell'ospitalità e del benessere, locali notturni e di tendenza, spazi collettivi e per comunità, luoghi dedicati ad occasioni mondane e incontri sociali sono solo alcuni degli ambiti eterogenei dove i pezzi Alias si collocano, con stile e discrezione, garantiscono la loro grande funzionalità ed esprimono il loro carattere, riconoscibile ovunque.

La leggerezza formale è il carisma silenzioso dei prodotti Alias, che hanno un disegno estremamente semplice, rigoroso, e nascono tutti dall'originale formula che ormai contraddistingue il marchio e si basa sul costante lavoro svolto dall'azienda nello sviluppo di ricerca creativa e progettuale, qualità di prodotto, innovazione di materiali e di tecnologie produttive.

Queste scelte, insieme a solida capacità produttiva, coerenza d'immagine e di comunicazione, intuizione di marketing e grande esperienza distributiva, hanno decretato il successo internazionale del marchio Alias e sono la ricetta che permette a questi pezzi di essere, in ogni ambiente, dei veri passepartout nella produzione di design di grande qualità.

Alias-Möbel unterstreichen dank ihrer charakteristischen transversalen Einsatzfähigkeit bei unterschiedlichsten Projekten eine hervorragende Eignung für den Contract-Bereich. Ein Einsatzgebiet mit vielseitigen Aspekten welches im umfassenden und kohärenten Produktkatalog wiedergespiegelt wird. Alias Kollektionen sind auch außerhalb der vertrauten heimischen vier Wände einsetzbar, durch ihre natürliche Einfachheit zum Einrichten der unterschiedlichsten Umgebungen – öffentlich oder privat, groß oder klein, Outdoor oder Indoor.

Öffentliche Warteräume oder Ausstellungen, Auditorien, Konferenz- und Versammlungsräume, Betriebsbüros, Redaktionen, Archive, Bibliotheken, Räumlichkeiten zur Religionsausübung, Besprechungsräume in Studios, Sport- und Kulturstätten, Verkaufsräume, exklusive Adressen aus dem Gastronomie-, Beherbergungs- und Wellnessbereich, Nacht- und Tendenzlokale, Räume für gesellschaftliche Veranstaltungen und soziale Treffen. Dies ist eine Auswahl der verschiedenen Ambiente, in denen das Mobiliar von Alias Verwendung findet. Mit Stil, Diskretion und herausragender Funktionalität, welche den Charakter von Alias bestimmen.

Die formale Leichtigkeit ist das Charisma von Alias Produkten, charakterisiert durch ein extrem einfaches und strenges Design, die alle aus der ursprünglichen charakteristischen Formel entstehen: Diese kennzeichnet sich durch eine ständige Arbeit für die Entwicklung im Bereich der kreativen und planerischen Forschung, Produktqualität und den Einsatz neuer Materialien und Produktionstechnologien.

Diese Schwerpunktsetzung hat zusammen mit einer soliden Produktionskapazität, der Kohärenz zwischen Image und Kommunikation, dem gezieltem Marketing und einer großen Erfahrung im Bereich der Distribution den internationalen Erfolg der Marke Alias bestimmt. Jedes einzelne Teil wird damit, unabhängig von der jeweiligen Umgebung, zu einem wahren Spiegelbild der Produktion eines hochwertigen Designs.

Grâce à leur polyvalence, les objets de design Alias se révèlent souvent propices aux collectivités, un domaine d'utilisation qui, dans ses nombreux aspects, correspond parfaitement à ce catalogue de produits toujours plus large, plus complet et plus homogène. Même lorsqu'elles sortent de l'intimité des murs de la maison, les collections Alias confirment leur facilité naturelle à décorer tous les lieux, publics et privés, grands et petits, extérieurs et intérieurs.

Les espaces publics destinés à l'attente ou les lieux d'exposition, auditoriums, salles de conférences ou de réunions, bureaux, rédactions, archives, bibliothèques, lieux de culte, salles d'étude, de sport ou de spectacle, magasins, grands noms de la restauration, de l'hospitalité et du bien-être, boîtes de nuit et lieux à la mode, espaces collectifs et pour collectivités, rendez-vous mondains et permanences sociales ne sont que quelques-uns des lieux hétérogènes où les articles Alias trouvent leur place, avec style et discrétion, garantissent une fonctionnalité totale et expriment leur personnalité, reconnaissable entre toutes.

La légèreté des formes est synonyme du charisme silencieux des produits Alias, au design extrêmement simple et rigoureux, qui germent tous de la formule originale qui caractérise désormais la marque et repose sur le travail constant déployé par l'entreprise pour développer la recherche créative et conceptuelle, la qualité de produit, l'innovation dans les matériaux et les technologies de production.

Ces choix, conjugués à une solide capacité de production, à une image et à une communication cohérentes, à une fine intuition commerciale et à une grande expérience dans la distribution ont scellé le succès international de la marque Alias et sont la recette qui permet à ces articles d'être partout à leur aise dans la production du design de grande qualité.



# company, production and distribution

Alias is based in Italy, in Grumello del Monte in the province of Bergamo. It comprises offices, production and warehouse. Alias has a sales network of around 800 shops in several countries in the world. It is based in Milan, Paris, London, Tokyo, New York, Toronto, Sydney, Seoul and Doha with dedicated commercial structures to the brand. Suggestive showrooms that present the company's entire production, and specialized staff is at the full disposal for architects, designers and contract clients.

La sede di Alias è in Italia, a Grumello del Monte in provincia di Bergamo. Comprende uffici, produzione e magazzino. Alias conta su una rete vendita di circa 800 negozi in diversi paesi nel mondo. È presente a Milano, Parigi, Londra, Tokyo, New York, Toronto, Sydney, Seoul e Doha con strutture commerciali dedicate al marchio, suggestivi showroom dove trovano spazio un'ampia selezione di prodotti Alias ed equipe di tecnici a disposizione di progettisti e clienti contract.

Alias hat seinen Sitz in Italien, in Grumello del Monte in der Provinz Bergamo. Es umfasst Büros, Produktion und Lager. Alias verfügt über ein Vertriebsnetz von rund 800 Geschäften in mehreren Ländern der Welt. In Milan, Paris, London, Tokyo, New York, Toronto, Sydney, Seoul und Doha wird die Marke Alias in speziell gewidmeten Ausstellungsräumen präsentiert. Suggestive Showrooms welche die komplette Alias Produktpalette ausstellen und mit geschultem Personal für alle Anfragen von Designern, Architekten und Contract Kunden zur Verfügung steht.

Le siège d'Alias est situé en Italie, à Grumello del Monte, dans la province de Bergame. Il comprend les bureaux, la production et l'entrepôt. Alias compte sur un réseau de vente d'environ 800 magasins dans différents pays du monde. Elle est basée à Milan, Paris, Londres, Tokyo, New York, Toronto, Sydney, Seoul et Doha avec des structures commerciales dédiées à la marque, des showroom suggestifs avec une ample sélection de produits Alias et des équipes de techniciens à disposition des architectes et clients contract.





# awards

## COMPASSO D'ORO ADI

 Laleggera  
Riccardo Blumer  
Compasso d'Oro 1998

 Highframe  
Alberto Meda  
Menzione d'onore  
Compasso d'Oro 1998

 Longframe  
Alberto Meda  
Menzione d'onore  
Compasso d'Oro 1998

 Teak table  
Alberto Meda  
Compasso d'Oro 2011

 Elle  
Eugeni Quitlet  
Menzione d'onore  
Compasso d'Oro 2014

 Stand Salone del Mobile  
Satuffacher - Sanguineti  
Menzione d'onore  
Compasso d'Oro 2014

 Kayak  
Patrick Norguet  
Menzione d'onore  
Compasso d'Oro 2016

## REDDOT AWARD

 Kayak  
Patrick Norguet  
**reddot award 2016**  
best of the best furniture design

 Twig 4  
Nendo  
**reddot award 2016**  
winner

 Rollingframe 52  
Alberto Meda  
**reddot award 2017**  
winner

 Time  
Alfredo Häberli  
**reddot winner 2020**

 E la nave va  
Atelier Oi  
**reddot winner 2021**  
furniture design

 Frametable outdoor  
Alberto Meda  
**reddot winner 2022**  
best of the best

## GERMAN BRAND AWARD

 german  
brand  
award  
19  
special

 german  
brand  
award  
19  
gold

## GERMAN DESIGN AWARD

 GERMAN  
DESIGN  
AWARD  
SPECIAL  
2019  
Okome bed  
Nendo

 GERMAN  
DESIGN  
AWARD  
WINNER  
2019  
Gran kobi essentiel  
Patrick Norguet

## ARCHIPRODUCTS DESIGN AWARD

 archiproducts  
DESIGN AWARD  
winner 2021  
Time  
Alfredo Häberli

 archiproducts  
DESIGN AWARD  
winner 2021  
E la nave va  
Atelier Oi



# INDEX



# CHAIRS

SEDIE • STÜHLE • CHAISES

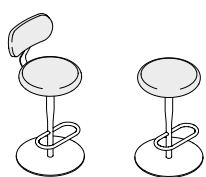

ATLAS  
pag. 12

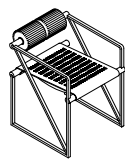

BOTTA  
pag. 20

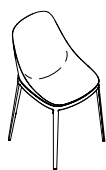

ELLE  
pag. 24

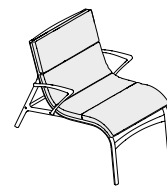
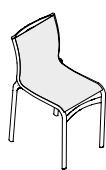

FRAME / FRAME SOFT  
pag. 28



KAYAK  
pag. 50

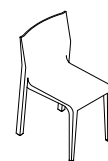

KOBI  
pag. 54

LADY COLLECTION  
pag. 62

LALEGGERA  
pag. 70

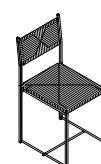
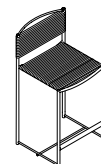
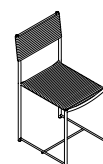
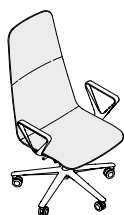

SLIM COLLECTION  
pag. 76

SLIM CHAIR  
pag. 84

SPAGHETTI / PALUDIS  
pag. 92



SEGESTA COLLECTION  
pag. 98

TAORMINA COLLECTION  
pag. 104

TWIG  
pag. 110



# ATLAS

JASPER MORRISON



Su un unico concetto di gamba, in acciaio conificato verniciato, si basa il progetto portante della collezione *atlas*. Dalla stessa struttura, su base tonda, si sviluppano pratici sgabelli di diversa altezza, disponibili con e senza schienale. Proposte in diverse finiture, le sedute *atlas* si accostano perfettamente ad un'altrettanta ampia collezione di tavoli arredando in modo riconoscibile e funzionale gli spazi.

Das Projekt der *atlas* Kollektion basiert auf dem Konzept eines einzigen konischen Standbeins aus lackiertem Stahl. Dieselbe Struktur auf einer runden Basis wird auch für praktische Hocker in verschiedenen Höhen benutzt, die mit oder ohne Rückenlehne angeboten werden. *Atlas* Hocker sind in verschiedenen Ausführungen verfügbar und sie passen perfekt zu der ebenso vielseitigen Tischkollektion. Zusammen richten sie Häuser und Objektbereiche auf funktionelle und erkennbare Weise ein.

The project of *atlas* collection is based on the single concept of a conical lacquered steel leg. Practical stools with different heights are developed on the same structure on a round base and they are available with or without backrest. *Atlas* are proposed in different finishes, and they perfectly match a likewise wide collection of tables, thus perfectly furnishing home and contract environments in a functional and recognisable way.

Le projet porteur de la collection *atlas* repose sur un même concept de piètement en acier conifié laqué. À partir de la même structure, sur une base ronde, sont développés des tabourets pratiques de différentes hauteurs, disponibles avec et sans dossier. Proposés dans différentes finitions, les sièges *atlas* se marient parfaitement à une vaste collection de tables, meublant ainsi de manière reconnaissable et fonctionnelle les espaces.

# ATLAS



ATLAS STOOL



ATLAS ADJUSTABLE STOOL

Il sistema *atlas* comprende sgabelli ad altezza regolabile, disponibili con o senza schienale. Come le altre sedute a collezione, la struttura di *atlas adjustable stool* prevede un pratico poggipiedi integrato nella gamba in acciaio.

*Atlas* system includes height-adjustable stools, available with or without backrest. Like all other seats of this collection, also the structure of *atlas adjustable stool* is equipped with a footrest integrated into the metal leg.

*Atlas*-System umfasst höhenverstellbare Hocker, die mit oder ohne Rückenlehne erhältlich sind. Wie bei allen anderen Sitzen dieser Kollektion ist auch die Struktur von *Atlas adjustable stool* mit einer in das Metallbein integrierten Fußstütze ausgestattet.

Le système *atlas* comprend des tabourets réglables en hauteur, disponibles avec ou sans dossier. Comme les autres sièges de la collection, la structure du tabouret réglable *atlas* comporte un repose-pieds pratique intégré au pied en acier.



# OVERVIEW

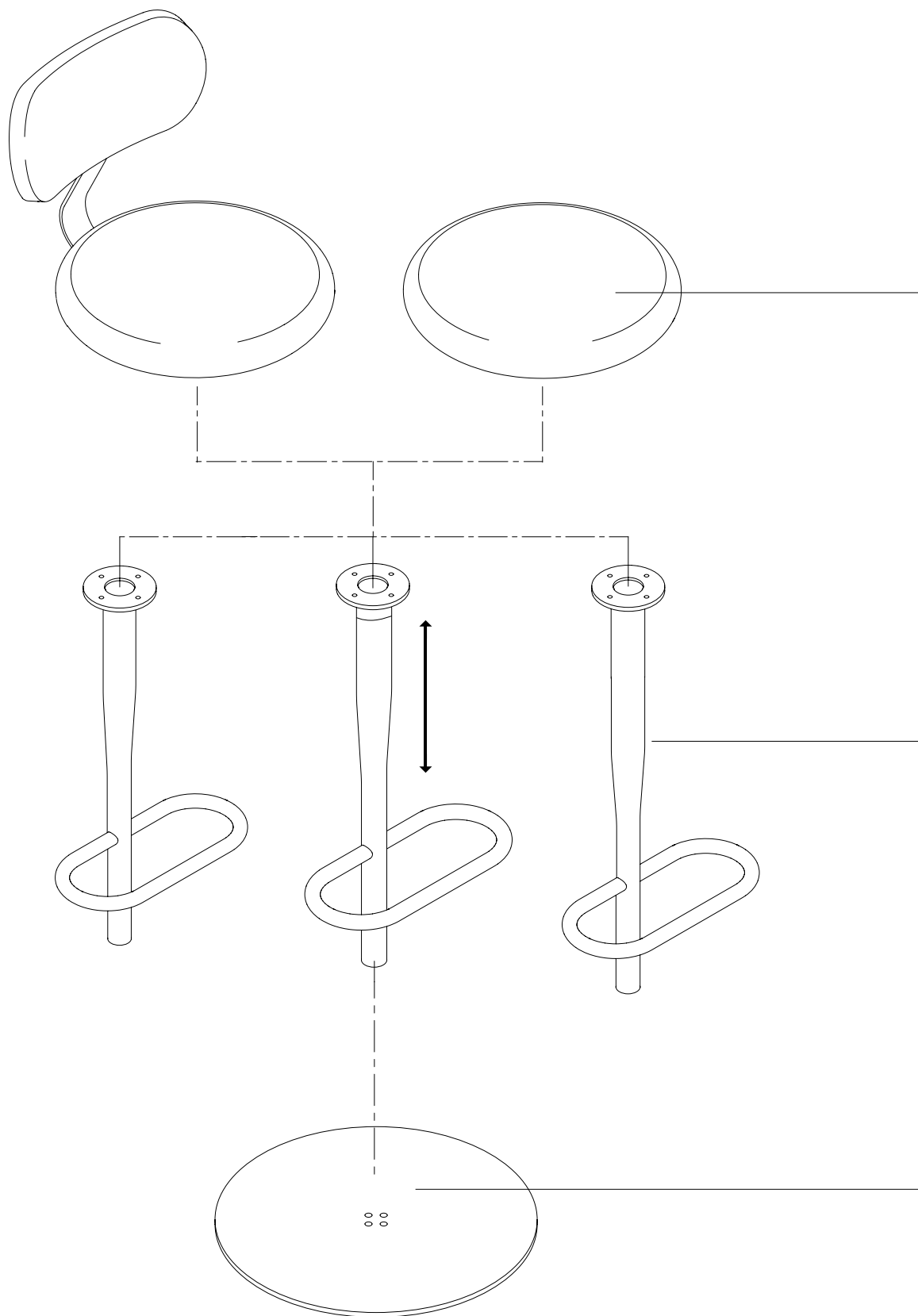

Swivel chair with backrest in plywood and expanded polyurethane upholstered with fabric, support in lacquered drawn steel.

Seduta girevole con schienale in multistrato curvato e poliuretano espanso rivestito in tessuto con supporto in acciaio trafilato verniciato.

Conical leg in lacquered steel. Available in 3 fixed and adjustable versions.

Gamba in acciaio conico verniciato. Disponibile in 3 versioni, fisse e regolabili.

Round base in textured lacquered steel, available in 5 finishes.

Base tonda in acciaio verniciato goffrato disponibile in 5 finiture.

## ATLAS TABLE



---

ATLAS TABLE



---

ATLAS LOW TABLE

Il sistema *atlas* comprende numerose tipologie coordinabili; una collezione di comodi sgabelli si accosta perfettamente ad un'altrettanta ampia collezione di tavoli e tavolini, disponibili in diverse finiture. *Atlas* è una collezione di tavoli moderni e componibili. La gamba in acciaio conificato, che caratterizza l'intero sistema, è proposta in diverse altezze e, accostata ai diversi piani, permette di realizzare le più svariate configurazioni.

The *atlas* system consists of various models that can be coordinated. A collection of comfortable stools perfectly matches a likewise wide collection of tables and small tables, available in different finishes. *Atlas* is a collection of modern and modular tables. The conical lacquered steel leg characterizes the whole system and is available in different heights; it can be matched with various table tops thus creating several configurations.

Das *atlas* System besteht aus unterschiedlichen Typologien, die koordiniert werden können. Eine Kollektion mit bequemen Hockern, die perfekt zu der ebenso vielseitigen Kollektion von Tischen und Beistelltischen in verschiedenen Ausführungen passt. *Atlas* ist eine Kollektion von modernen, modularen Tischen. Das konische Standbein aus Stahl, das das gesamte System kennzeichnet, ist in verschiedenen Höhen erhältlich und in Kombination mit den unterschiedlichen Platten ermöglicht es die verschiedensten Konfigurationen.

Le système *atlas* comprend nombreuses typologies coordonnables; une collection de tabourets confortables est parfaitement assortie à une collection tout aussi vaste de tables et de tables basses, disponibles en différentes finitions. *Atlas* est une collection de tables modernes et modulaires. Le pied en acier conique, qui caractérise l'ensemble du système, est proposé en différentes hauteurs et, combiné aux différents plateaux, permet de réaliser les configurations les plus variées.

# OVERVIEW

Round tops in:

- full color plywood (thickness 12 mm)
- aluminium faced with laminate (thickness 6 mm)
- veneered aluminium (thickness 6 mm)
- marble (thickness 10 mm)

Piani tondi in:

- stratificato full color (spessore 12 mm)
- alluminio con laminato (spessore 6 mm)
- alluminio impiallacciato (spessore 6 mm)
- marmo (spessore 10 mm)

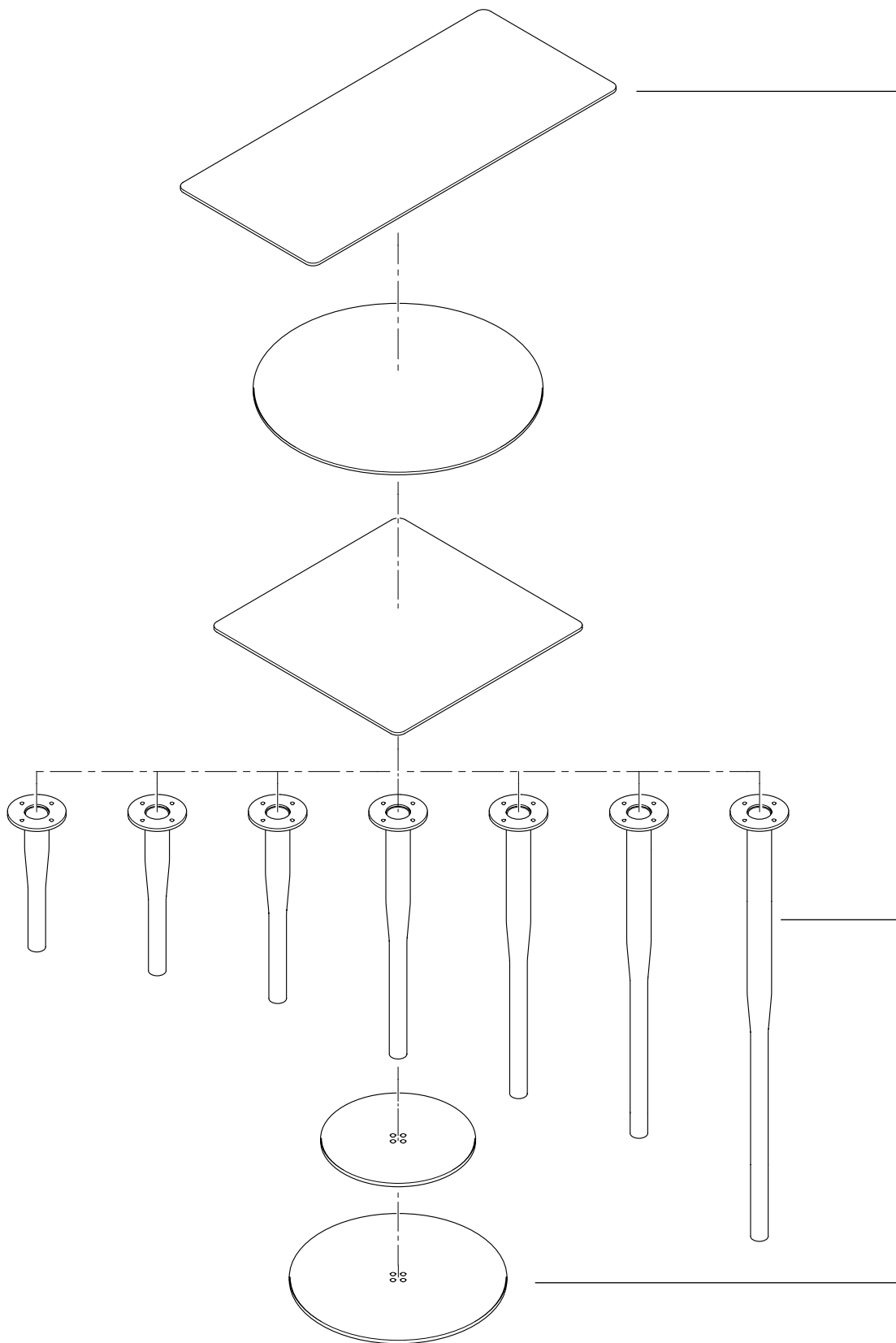

Conical leg in lacquered steel.  
Available in different heights.  
Gamba in acciaio conico  
verniciato. Disponibile in varie  
altezze.

Round base in textured lacquered  
steel, available in 5 finishes.  
Base tonda in acciaio verniciato  
goffrato disponibile in 5 finiture.

# INTERIOR SOLUTION



**ATLAS STOOL**  
 FINISHES: TEXTURED LACQUERED STEEL (A011) FABRIC KVADRAT®  
**ATLAS TABLE M**  
 FINISHES: TEXTURED LACQUERED ALUMINIUM/STEEL (A011) FULL COLOR (FC04)

## DIMENSIONS

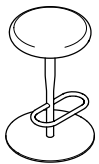

**ATLAS STOOL / 756 - 760**  
 Ø cm 40 - h cm 70/80

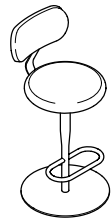

**ATLAS STOOL / 758 - 762**  
 Ø cm 40 - h cm 100/110 -  
 h seat cm 70/80

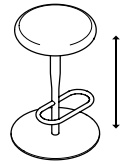

**ATLAS ADJUSTABLE STOOL / 757**  
 Ø cm 40 - h cm 65 ↔ 76

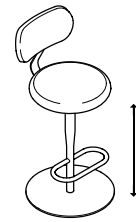

**ATLAS ADJUSTABLE STOOL / 759**  
 Ø cm 40 - h cm 95 ↔ 106 - h seat cm 65 ↔ 76



**ATLAS TABLE & ATLAS LOW TABLE (example configurations)**  
 Ø cm 60 - h cm 34

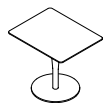

cm 40x50 - h cm 40

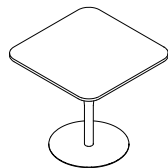

cm 80x80 - h cm 74,5

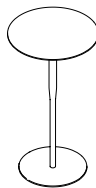

Ø cm 60 - h cm 108

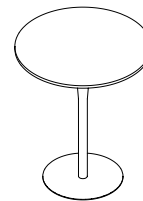

Ø cm 90 - h cm 108

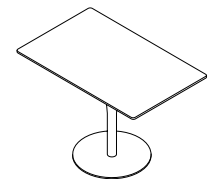

**ATLAS TABLE PRIVACY / EH1 - EH2 - EH3**  
 cm 70x32 - h cm 73,5  
 cm 110x70 - h cm 73,5  
 cm 160x70 - h cm 73,5

Scopri tutti i prodotti della collezione Atlas table su [alias.design](https://alias.design)  
 Discover all products of Atlas table collection on [alias.design](https://alias.design)

**EH1 - EH2 - EH3**  
 Tavolo consigliato per divani eleven high back privacy  
 Recommended table for eleven high back privacy sofas

# FINISHES

## STRUTTURA / STRUCTURE / GESTELL / STRUCTURE

Alluminio/Acciaio verniciato gofrato  
Textured lacquered aluminium/steel  
Aluminium/Stahl lackiert gerauht  
Aluminium/acier laqué granité



A019    A011    A047    A022    A051

## PIANO / TOP / TISCHPLATTE / PLATEAU

Laminato  
Laminate  
Laminat  
Laminé

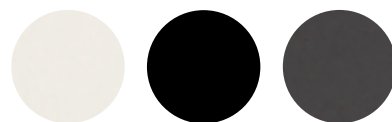

L010    L006    L005

Full color / Full color verniciato  
Full color / lacquered Full color  
Full color / Full Color lackiert  
Full color / Full color Laqué



FC01    FC04    V003    V007    V110

Marmo bianco di Carrara  
Marble bianco Carrara  
Marmor bianco Carrara  
Marbre bianco Carrara

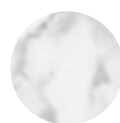

MA01

Essenze  
Wood  
Holzarten  
Bois

Rovere  
Oak  
Eiche  
Chêne

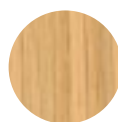

RV

Rovere tinto noce canaletto  
Stained oak canaletto walnut  
Eiche Gebeizt canaletto nußbaum  
Chêne teinté noyer canaletto



NCT

Rovere sbiancato  
White oak  
Eiche gebleicht  
Chêne blanchi



RVS

Rovere grigio cenere  
Ash grey oak  
Eiche aschgrau  
Chêne gris cendré



RC

Acero naturale  
Natural maple  
Ahorn natur  
Erable naturel



ACN

## SEDUTA & SCHIENALE / SEAT & BACK / SITZ & RÜCKENLEHNE / ASSISE & DOSSIER

Tessuti  
Fabric  
Stoff  
Tissu

**Camira® A**  
Xtreme  
Urban

**Kvadrat® B**  
Maple  
Remix  
Tonus

**Kvadrat® C**  
Canvas  
Divina  
Foss  
Hallingdal 65  
Hero  
Steelcut  
Steelcut Trio

Ecopelle  
Eco-leather  
Kunstleder  
Simili cuir

**Serge Ferrari®**  
Stamskin Top®



# BOTTA

MARIO BOTTA



Forme archetipe della geometria architettonica ispirano questo storico masterpiece. Progettata dal grande architetto ticinese Mario Botta per gli interni di alcune sue note architetture, la sedia *seconda* è ormai un classico del catalogo Alias, vera e propria icona del design Made in Italy.

Dieses historische Meisterwerk lässt sich von den Urformen der architektonischen Geometrie inspirieren. Der *seconda* Stuhl vom berühmten Tessiner Architekten Mario Botta wurde ursprünglich für die Raumgestaltung einiger seiner berühmten Gebäude entworfen und ist mittlerweile ein Klassiker von Alias Katalog geworden, ein echtes Ikon des Designs "Made in Italy".

This historical masterpiece is inspired by archetypal shapes of architectural geometry. Designed by the great architect Mario Botta, from the Ticino canton, for the interiors of some of his famous buildings, *seconda* chair has become a classic in Alias catalogue, a true icon of Made in Italy design.

Les formes caractéristiques de la géométrie architecturale inspirent ce chef-d'œuvre historique. Conçue par le grand architecte tessinois Mario Botta pour les intérieurs de certains de ses célèbres réalisations, la chaise *seconda* est désormais un classique du catalogue Alias, une véritable icône du design Made in Italy.

## SECONDA



La sedia, composta da acciaio e poliuretano, racchiude in se elementi tipici del razionalismo come la purezza delle forme geometriche, che l'architetto Mario Botta descrive come "segni primari creati dalla mente matematica dell'uomo".

The chair is made of steel and polyurethane and it features typical elements of rationalism, such as the purity of geometrical shapes, which the architect Mario Botta describes as "primary signs generated by man's mathematical mind".

Der Stuhl besteht aus Stahl und Polyurethan und enthält typische Elemente des Rationalismus, wie die Reinheit der geometrischen Formen, die der Architekt Mario Botta als "von der mathematischen Verstand des Menschen geschafften primären Zeichen" bezeichnet.

La chaise, composée d'acier et de polyuréthane, intègre des éléments typiques du rationalisme comme la pureté des formes géométriques, que l'architecte Mario Botta décrit comme "signes primaires créés par l'esprit mathématique de l'homme".

## DIMENSION



SECONDA / 602

cm 52x58 - h cm 72 - h seat cm 46

## FINISHES

Acciaio verniciato liscio  
Smooth lacquered steel  
Glatt lackiertes Stahl  
Acier laqué lisse



A009







# ELLE

EUGENI QUITLLET



Eugeni Quitllet ama arrivare all'essenza degli oggetti. Svelarne l'anima in una visione inusuale e intensa. Accade con *elle*. Elegante e confortevole, crea mescolando materiali differenti. Slanciato e sensuale il design. Inclinata leggermente in avanti, la base conferisce una sensazione di dinamismo. La sottile linea di giunzione fra scocca e struttura genera un movimento fluido e continuo. Piccoli ma efficaci accorgimenti ergonomici garantiscono un adeguato livello di comfort.

Eugeni Quitllet dringt zur Essenz der Dinge vor. Er enthüllt ihre Seele und zeigt sie in einer ungewöhnlichen Perspektive mit intensiver Wirkung. Das jüngste Beispiel ist *elle*. Elegant und komfortabel, ein Mix unterschiedlicher Materialien. Schlankes, sinnliches Design. Das leicht nach vorn geneigte Gestell vermittelt den Eindruck von Dynamik. Die feine Verbindung zwischen Schale und Struktur generiert eine fließende, durchgehende Bewegung. Die kleinen aber äußerst effizienten ergonomischen Details garantieren angemessenen Komfort.

Eugeni Quitllet loves exploring the very essence of objects, revealing their inner soul in an unusual and intense vision. This is certainly the case with *elle*. Elegant and comfortable, it has been created by combining different materials. It has an angled and sensual design, with a sensation of dynamism created by the slight forward inclination of its base. The thin joint line between the shell and the structure creates a flowing and continuous movement. The chair features a number of small but effective ergonomic devices thereby ensuring a high standard of comfort.

Eugeni Quitllet vise l'essence des objets. Il révèle leur âme dans une version originale et intense. C'est le cas avec *elle*. Élégante et confortable, issue du mélange de différents matériaux. Son design est élané et sensuel. Légèrement incliné vers l'avant, son piètement crée une impression de dynamisme. La fine ligne de jonction entre la coque et la structure engendre un mouvement fluide et continu. Des astuces ergonomiques discrètes mais efficaces garantissent un confort parfait.

ELLE



---

ELLE

---

ELLE SOFT



---

ELLE ARM



---

ELLE ARM SOFT



XXIII COMPASSO D'ORO ADI  
PREMIO MENZIONE D'ONORE  
PRIZE OF HONORABLE MENTION

## DIMENSIONS



ELLE / 070

cm 47x53 - h cm 85 - h seat cm 47

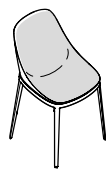

ELLE SOFT / 071

cm 47x53 - h cm 85 - h seat cm 49



ELLE ARM / 073

cm 61x53 - h cm 85 - h seat cm 47



ELLE ARM SOFT / 072

cm 61x53 - h cm 85 - h seat cm 49

## FINISHES

### STRUTTURA / STRUCTURE / GESTELL / STRUCTURE

Alluminio verniciato gofrato  
Textured lacquered aluminium  
Lackiertes gerauhtes Aluminium  
Aluminium laqué granité



A019



A011

### SCOCCA / SHELL / SITZSCHALE / COQUE

Poliuretano TECH®  
Polyurethane TECH®  
Polyurethan TECH®  
Polyuréthane TECH®



PH02



PH01

### CUSCINO / PAD / KISSEN / COUSSIN

Tessuti  
Fabric  
Stoff  
Tissu

Camira® A  
Xtreme  
Urban

Kvadrat® B  
Remix  
Tonus

Kvadrat® C  
Canvas  
Divina  
Foss  
Hallingdal 65  
Hero  
Steelcut  
Steelcut Trio

pelle Pelle Frau® SC ColorSphere®  
Pelle Frau® SC ColorSphere® leather  
Leder Frau® SC ColorSphere®  
Cuir Pelle Frau® SC ColorSphere®



B004



B020



B026



B056



B057



B080

altri colori disponibili su richiesta  
other colours available on request



# FRAME

ALBERTO MEDA



La rete di poliestere spalmata con PVC, nelle sue tante varianti cromatiche, su struttura in profilo d'alluminio estruso ed elementi in pressofusione verniciato, è l'elemento comune dei prodotti dell'insieme *frame*. Declinata in tipologie tutte diversamente pensate per combinare comfort e funzione, la collezione *frame* è un progetto di grande successo diventato negli anni icona di riferimento per altre produzioni.

Das PVC-beschichtete Polyesternetz mit seinen vielen Farben und das lackierte Gestell aus fließgepresstem Aluminium und Aluminiumdruckgusselementen sind die charakteristischen Element der Serie *frame*. Diese präsentiert sich in ganz unterschiedlich durchdachten Varianten um Komfort und Funktion harmonisch zu kombinieren. *Frame* ist eine erfolgreiche Kollektion, die im Laufe der Jahre auch Anhaltspunkt für andere Projekte gewesen ist.

The *frame* collection is characterised by PVC covered polyester mesh available in many colour variants, with a structure in extruded aluminium and lacquered die casting components. Comprised of an array of products, each designed differently to combine comfort and function, *frame* is a successful collection which has become over the years an icon for other collections.

Le tissu maillé en polyester enduit de PVC, avec ses nombreuses variantes chromatiques, sur une structure en profil d'aluminium extrudé et éléments en fonte d'aluminium laqué est l'élément commun des produits de la gamme *frame*. Déclinée dans des typologies différentes mais qui allient toutes confort et fonction, la collection *frame* est un projet de grand succès qui est devenu au cours des années une icône de référence pour d'autres productions.

## FRAME CHAIR



HIGHFRAME 40



BIGFRAME 44



FRAME 52



FRAME 52 SOFT  
(Available only for outdoor use)

Seat and back in mesh, removable and draining cushion.  
Seduta e schienale in rete, cuscino removibile e drenante.

I prodotti dell'insieme *frame* svelano un segno leggero e rigoroso, che si concretizza in sedute confortevoli. Di diverse proporzioni le sedie impilabili *highframe*, *bigframe* e *frame 52* sono disponibili con o senza braccioli. Ad arricchire la variante con seduta e schienale in rete di poliestere spalmata con PVC, le versioni in pelle e in tessuto per uno stile sobrio ed informale.

The products of *frame* collection express light and accurate lines that create comfortable chairs. The stackable chairs *highframe*, *bigframe* and *frame 52* differentiate in their sizes and are available with or without armrests. The chairs with PVC covered polyester mesh are completed with the leather and the fabric versions, giving them a sober and informal style.

Die Produkte der Kollektion *frame* sind von leichten und rigorosen Linien gekennzeichnet, die bequeme Sitzmöbel erschaffen. Die stapelbaren Stühlen *highframe*, *bigframe* und *frame 52* haben verschiedenen Abmessungen und sind mit oder ohne Armlehnen erhältlich. Die Leder- und Stoffversion bereichern die Variante aus PVC beschichtetem Polyesternetzgewebe und zeigen einen schlichten und informellen Stil.

Les produits de la collection *frame* dévoilent un caractère léger et rigoureux qui se traduit par des assises confortables. Les chaises empilables *highframe*, *bigframe* et *frame 52*, en différentes proportions, sont disponibles avec ou sans accoudoirs. Pour enrichir la variante avec assise et dossier en tissu maillé de polyester enduit de PVC, les versions en cuir et en tissu avec un style sobre et informel.



## INTERIOR SOLUTIONS



### FRAMETABLE FOLDING

FINISHES: TEXTURED LACQUERED ALUMINIUM (A011) LAMINATE (L005)

### HIGHFRAME

FINISHES: TEXTURED LACQUERED ALUMINIUM (A011) MESH (R007)



### BIGFRAME 44

FINISHES: TEXTURED LACQUERED ALUMINIUM (A019) / FABRIC KVADRAT@ A

### BIPLANE Ø140

FINISHES: TEXTURED LACQUERED ALUMINIUM (A019) LACQUERED MDF (V001)

# ACCESSORIES

Da utilizzarsi su sedie predisposte.  
To be used on prepared chairs.

## frame tablet 451

Writing tablet in Full Color black with metallic chrome connection for seats with arms of frame collections. Available right and left versions.

Piano scrittoio in full color nero con attacco metallico cromato per le sedute con braccioli della frame collection. Disponibile nella versione destra e sinistra.

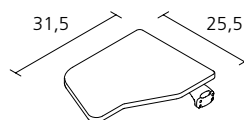

## armrest+ 455

Accessories for seats with arms. Available in: integral polyurethane foam (black self skinning) and in integral polyurethane foam covered with Pelle Frau® leather (B020).

Accessori per le sedute con braccioli. Disponibile in: poliuretano integrale (autopellante nero) e in poliuretano integrale rivestito in Pelle Frau® (B020).

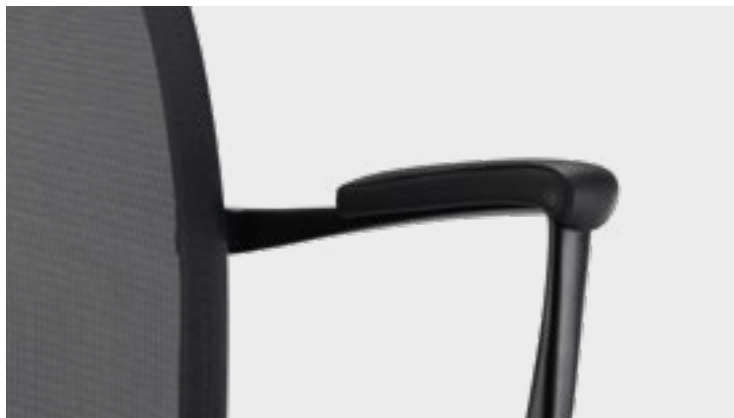

## frame link 421

Giunto di collegamento in nylon bianco per sedie (da utilizzarsi su sedie preposte per l'attacco giunto).

Linking device in white nylon for seat (to be used for chairs with coupling link).

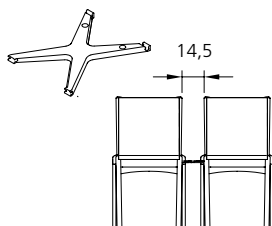

## frame link 422 - 423

Giunto di collegamento regolabile a terra in acciaio verniciato grigio chiaro (A051) con inserti in nylon.

Adjustable floor base linking device in lacquered steel in light grey (A051) colour with nylon inserts.

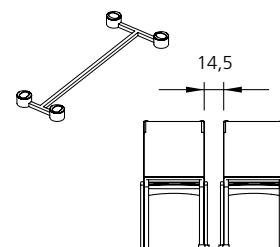

## frame trolley

Carrello porta-sedie in acciaio verniciato grigio chiaro (A051). Porta fino a 15 sedie senza braccioli con rivestimento in rete e fino a 5 con rivestimento in tessuto o pelle

Chair carrying trolley in lacquered steel in light grey (A051) colour. For up to 15 chairs without arms with upholstery in mesh and up to 5 chairs with upholstery in fabric or leather.



## impilabilità / stackability

Numero massimo di sedie impilabili.

Maximum number of chairs for stacking.

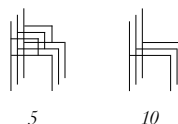

# DIMENSIONS

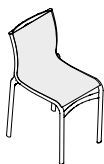

HIGHFRAME 40 / 416 \*

cm 40x56 - h cm 82 - h seat cm 48



HIGHFRAME 40 / 417 \*

cm 51x56 - h cm 82 - h seat cm 48

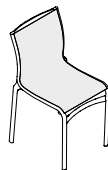

BIGFRAME 44 / 441 \*

cm 48x61 - h cm 86 - h seat cm 47



BIGFRAME 44 / 440 \*

cm 55x61 - h cm 86 - h seat cm 47

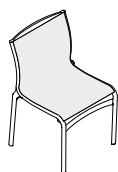

FRAME 52 / 458 \*

cm 56,5x66,5 - h cm 83 - h seat cm 47



FRAME 52 / 459 \*

cm 63x66,5 - h cm 83 - h seat cm 47

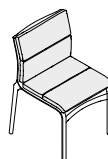

FRAME 52 SOFT OUTDOOR / 408\_O

cm 56,5x66,5 - h cm 83 - h seat cm 50

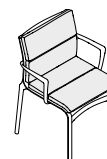

FRAME 52 SOFT OUTDOOR / 409\_O

cm 63x66,5 - h cm 83 - h seat cm 50

highframe 40



bigframe 44

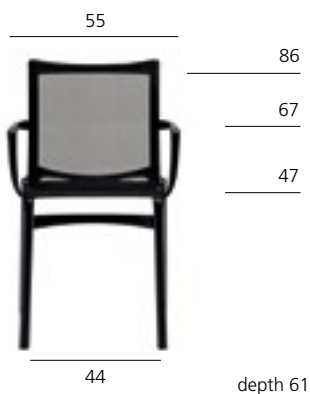

frame 52

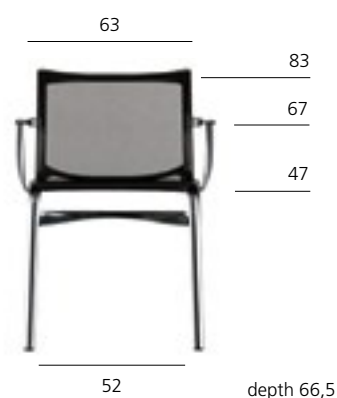

Le sedie della collezione *frame* sono dotate di piedini morbidi nelle gambe anteriori e rigidi nelle gambe posteriori. Per ogni sedia viene fornito un kit di piedini posteriori morbidi per pavimenti in legno.

The chairs of the *frame* collection have soft feet under the front legs and hard feet under the back legs. For each chair is provided a kit of soft rear feet for wood floors.

Die Stühle der Kollektion *frame* haben weiche Gleiter für die vorderen Beine, und harte Gleiter für die hinteren Beine. Für jeden Stuhl ist ein Satz von weichen hinteren Gleitern für Holzböden versehen.

Les chaises de la collection *frame* sont équipées de patins souples sur les pieds antérieurs, et durs sur les pieds postérieurs. Pour chaque chaise nous fournissons un kit de patins postérieurs souples pour parquet.



**FRAME 52 SOFT OUTDOOR**  
Seat and back in mesh, removable and draining cushion. Seduta e schienale in rete, cuscino removibile e drenante.

\* AVAILABLE FOR OUTDOOR

## FRAME STOOL



Perfettamente coerenti con il progetto *highframe*, che dal 1994 continua a rappresentare uno dei grandi successi di Alias, gli sgabelli *frame stool* sono proposti con altezza seduta di 65 o 80 centimetri.

Perfectly in line with the *highframe* project, one of Alias's main successes since 1994, the *frame stools* are proposed with seatheight 65 and 80 cm.

Die Hocker *frame stools* mit Sitzhöhen 65 und 80 Zentimetern sind perfekt kohärent mit dem Projekt *highframe*, das seit 1994 eines der erfolgreichsten Produkte von Alias darstellt.

Parfaitement cohérents avec le projet *highframe* qui, depuis 1994 continue à représenter un des grands succès d'Alias, les tabourets *frame stool* sont proposés dans les hauteurs d'assise de 65 et 80 centimètres.

## DIMENSIONS

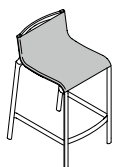

FRAME STOOL / 41A

cm 49x56 - h cm 86 - h seat cm 65

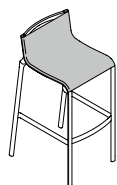

FRAME HIGH STOOL / 41B

cm 49x56 - h cm 101 - h seat cm 80



h. schienale 21 cm  
h. backrest 21 cm  
h. Rückenlehne 21 cm  
h. dossier 21 cm

In caso di struttura lucidata o cromata, il poggiatesta è verniciato grigio grafite (A022).  
With polished or chromed structure, the footrest is lacquered graphite grey (A022).  
Bei polierter oder verchromter Struktur ist die Fußstütze graphitgrau lackiert (A022).  
Avec structure polie ou chromée, le repose-pieds est laqué gris graphite (A022).

**FRAME STOOL**  
ALUMINIUM (CR / A022) PELLE FRAU® (B020)  
**FRAME STOOL HIGH**  
ALUMINIUM (A011 / A022) MESH (R007)



## ROLLINGFRAME



ROLLINGFRAME 44



ROLLINGFRAME+ TILT 47

ROLLINGFRAME+ TILT 47 SOFT

ROLLINGFRAME+ LOW TILT 47 SOFT

Le sedie con base a cinque razze *rollingframe* sono capaci di trasferirsi con disinvolta eleganza dalla dimensione più privata dell'home office all'ufficio direzionale, agli uffici operativi. La base girevole sostiene una seduta ergonomica, ancora più confortevole nella versione plus dotata di meccanismo oscillante.

*Rollingframe* chairs with five-star bases can easily and elegantly adapt to the more private dimension of the home office as well as to executive and operative offices. The swivel base supports an ergonomic seat, also available in the more comfortable "plus" version, which is equipped with tilting mechanism.

Die *rollingframe* Stühle auf Fünfsterfuß können mit ihrer ungezwungenen Eleganz im eigenen Homeoffice bis zum Direktionsbüro und operativen Büros verwendet werden. Das drehbare Gestell trägt eine ergonomische Sitzfläche und die bequemere Version „plus“ ist mit Kippmechanismus ausgestattet.

Les chaises avec piètement à cinq branches *rollingframe* sont capables de passer avec élégance de la dimension la plus privée du home office aux bureaux de direction et opérationnels. La base tournante soutient une assise ergonomique et encore plus confortable dans la version plus équipée d'un mécanisme oscillant.

## ROLLINGFRAME



reddot award 2017  
winner

ROLLINGFRAME 52



ROLLINGFRAME 52 SOFT



La seduta **rollingframe 52** con braccioli in poliuretano risponde alla normativa **UNI EN1335-1:200 Type C**, relativa ai principi ergonomici e requisiti funzionali minimi per le sedie da ufficio.

The **rollingframe 52** chair with armrest in polyurethane comply with **UNI EN1335-1:200 Type C** standards relating to ergonomic principles and minimal functional requirements for office chairs.

Der Stuhl **rollingframe 52** mit Armlehnen aus Polyurethan entspricht den Ergonomie-Richtlinien **UNI EN1335-1:200 Type C** und den Mindestanforderungen für Bürostühle.

Le siège **rollingframe 52** avec accoudoirs en polyuréthane est conforme à la norme **UNI EN1335-1:200 Type C** en matière de principes ergonomiques et de critères fonctionnels minimum des chaises de bureau.

## MEETINGFRAME



MEETINGFRAME 44



MEETINGFRAME + TILT 47

MEETINGFRAME + TILT 47 SOFT

Grazie al tratto pulito ed essenziale che disegna la struttura, le sedie girevoli auto allineanti *meetingframe* e *meetingframe+TILT* con base a 4 razze con scivoli, sono ideali per le sale riunioni e le situazioni meeting. Hanno struttura composta da profilo di alluminio estruso ed elementi pressofusi di alluminio, seduta e schienale in rete ignifuga di poliestere spalmata con PVC o in pelle o in tessuto.

The self-adjusting swivel chairs *meetingframe* and *meetingframe+TILT* with their 4-star base with glides are perfect for meeting rooms thanks to the clean and essential line used to design the structure. It is made of extruded and die-cast aluminum elements; seat and back are in fire retardant PVC covered polyester mesh, in leather or in fabric.

Die drehbaren Stühle *meetingframe* und *meetingframe+TILT* haben einen 4-Sternausleger auf Gleitern und die Rückholmechanik. Dank der reinen und essenziellen Linien des Gestells sind sie ideal für Versammlungsräume und Büros. Das Gestell besteht aus fließgepresstem und Aluminiumdruckgußelementen, Sitz und Rückenlehne sind aus feuerhemmendem PVC-beschichtetem Polyesternetzgewebe, aus Leder oder aus Stoff.

Grace au dessin linéaire et essentiel qui caractérise la structure, les chaises tournantes avec repositionnement automatique *meetingframe* et *meetingframe+TILT* avec base à 4 branches avec patins, sont idéales pour les salles de réunion et les espaces meeting. La structure est composée de profil d'aluminium extrudé et d'éléments en fonte d'aluminium, assise et dossier en tissu polyester maillé ignifuge enduit de PVC ou en cuir ou en tissu.



# MEETINGFRAME



MEETINGFRAME 52



MEETINGFRAME 52 SOFT



MEETINGFRAME LOUNGE 52



MEETINGFRAME LOUNGE 52 SOFT

Le proporzioni generose rendono *meetingframe 52* ideali per il seating tecnico informale, l'home office e le sale riunioni; grazie alla variante lounge trovano ideale collocazione anche nelle zone relax e lounge.

The generous proportions make *meetingframe 52* ideal for informal technical seating, home offices and meeting rooms; thanks to the lounge variant, they are also ideal for relax and lounge areas.

Dank der großzügigen Proportionen ist *meetingframe 52* ideal für informelle technische Sitzgelegenheiten, Homeoffices und Besprechungsräume. Dank der Lounge-Variante ist es einfach, auch Entspannungs- und Loungebereiche einzurichten.

Grâce à leur proportions généreuses, *meetingframe 52* sont idéales pour le seating technique informel, l'home office et les salles de réunion ; grâce à la variante lounge, elles sont également idéales pour les espaces de détente et les salons.

## FRAME TILT

ROLLINGFRAME/MEETINGFRAME

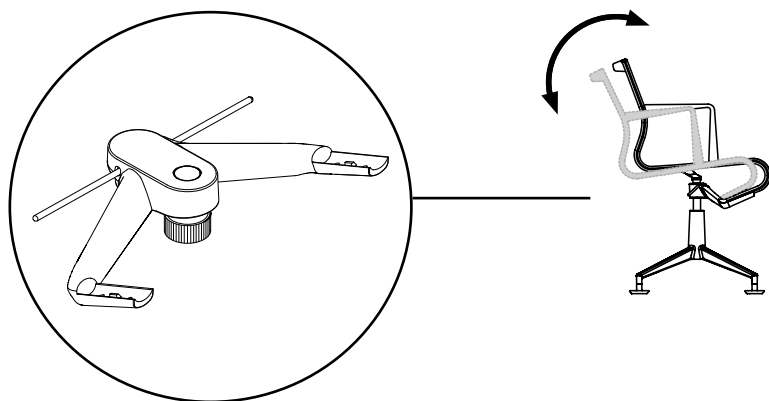

Il tilt aumenta il comfort di **rollingframe** e **meetingframe**, rendendo possibile l'inclinazione contemporanea della seduta con lo schienale. A seconda del peso dell'utente è possibile regolare la durezza della molla che governa il meccanismo oscillante.

The tilting action enhances the degree of comfort provided by **rollingframe** and **meetingframe** chairs, since the angles of inclination of the seat and back can be adjusted simultaneously. The hardness of the spring that controls the tilting mechanism can be adjusted as a function of user weight.

Das Kippmechanismus erhöht den Komfort von **rollingframe** und **meetingframe** und ermöglicht die gleichzeitige Schrägstellung von Sitzfläche und Rückenlehne. Je nach Gewicht des Nutzers kann die Härte der Feder des Kippmechanismus eingestellt werden.

Le tilt améliore le confort de **rollingframe** et de **meetingframe** en permettant d'incliner l'assise en même temps que le dossier. Selon son poids, l'utilisateur module la dureté du ressort qui règle le mécanisme d'oscillation.

## INTERIOR SOLUTIONS



### ROLLINGFRAME+ TILT 47

FINISHES: TEXTURED LACQUERED ALUMINIUM (A011) / FABRIC CAMIRA®

TEC SYSTEM

FINISHES: TEXTURED LACQUERED ALUMINIUM (A019) / FULL COLOR (FC01)



### MEETINGFRAME 44

FINISHES: ALUMINIUM POLISHED (AB) / FABRIC KVADRAT®

FRAMETABLE OVAL 295XL

FINISHES: ALUMINIUM POLISHED (AB) / VENEERED NATURAL OAK (RV)

# DIMENSIONS

## ROLLINGFRAME

rollingframe 44 / 434

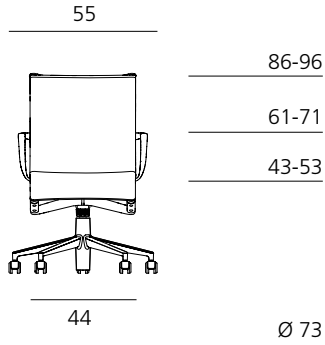

rollingframe+ TILT 47 / 445

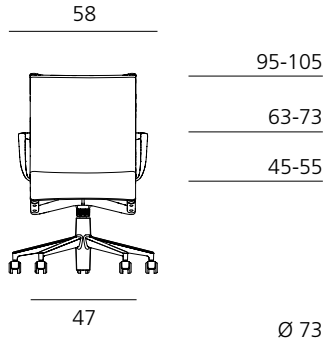

rollingframe+ TILT 47 soft / 453

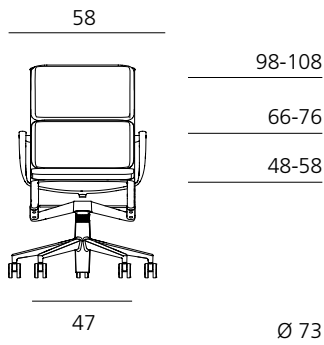

rollingframe+ low TILT 47 soft / 427

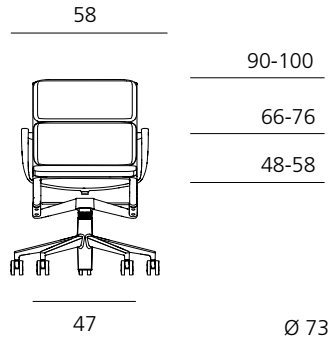

rollingframe 52 / 472

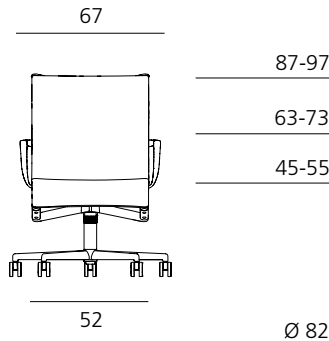

rollingframe 52 soft / 474

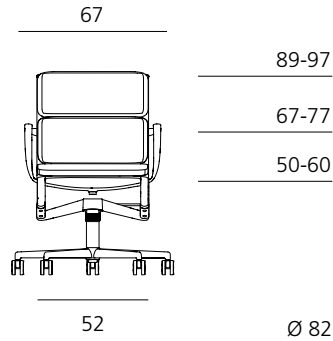

frame castors

Rollingframe è disponibile con ruote frenanti morbide o rigide.  
 Rollingframe is available with soft or hard breaking castors.  
 Rollingframe 52 è disponibile con ruote morbide autofrenanti da diametro 65 mm.  
 Rollingframe 52 is available with 65 mm diameter soft breaking castors.

# DIMENSIONS

## MEETINGFRAME

meetingframe 44 / 437

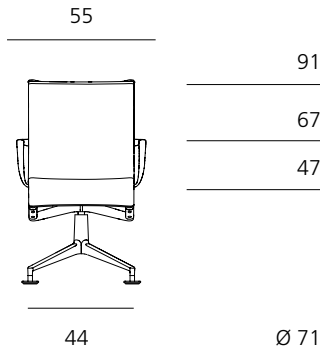

meetingframe+ tilt 47 / 447

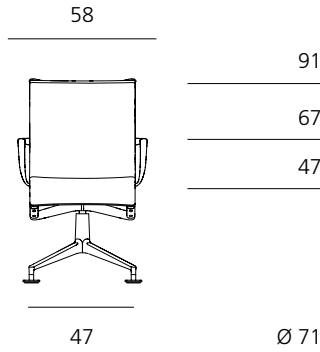

meetingframe+ tilt 47 soft / 429

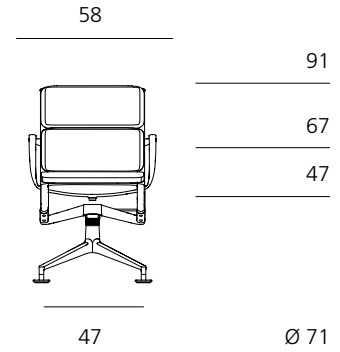

meetingframe 52 / 482

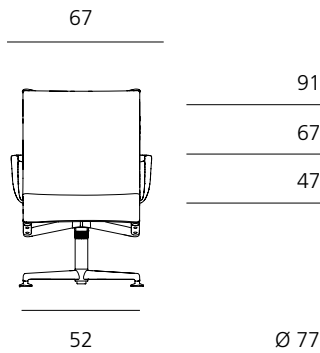

meetingframe 52 soft / 484

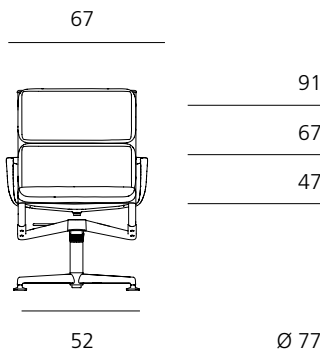

meetingframe lounge 52 / 435

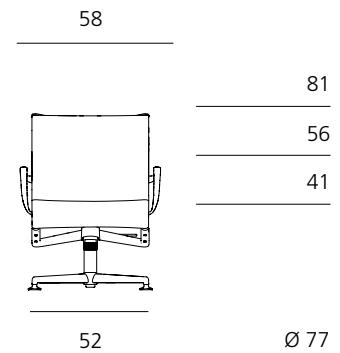

meetingframe lounge 52 soft / 469

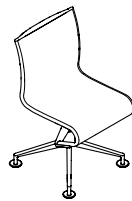
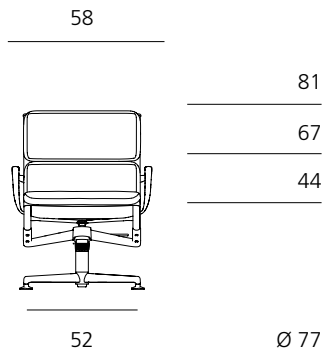

Meetingframe è autoallineante.  
Meetingframe is self adjusting.



armrest+

Accessori per le sedute con braccioli. Disponibile in: poliuretano integrale (autopellante) e in poliuretano integrale rivestito in Pelle Frau®.

Accessories for seats with arms. Available in: integral polyurethane foam (self skinning) and in integral polyurethane foam covered with Pelle Frau® leather.



# FRAME LOUNGE



LONGFRAME SOFT



ARMFRAME SOFT / FEETFRAME SOFT

La caratteristica struttura in alluminio estruso si allunga nella poltroncina *armframe* (corredabile con poggipiedi) fino a creare una sinuosa silhouette nella chaise longue *longframe*. Per i momenti di relax, le due sedute regalano all'ambiente stile, armonia e bellezza, esprimendo un design pratico ed elegante rivolto al benessere e al comfort.

The distinctive structure in extruded aluminium of frame collection is used again both for the armframe *armchair* (also available with footstool) and the elegant chaise longue *longframe*. Ideal for relaxing moments, both seats enhance any environment with style, harmony and beauty, yet also providing wellbeing and comfort with a practical and elegant design.

Das unverwechselbare Aluminiumgestell der frame Familie wurde auch für den Sessel *armframe* (verfügbar auch mit Hocker) und für die elegante Liege *longframe* verwendet. Diese zwei Modelle sind ideal zum Ausruhen im Freien und sie vermitteln jedem Umfeld Stil, Harmonie und Eleganz. Sie haben ein praktisches und elegantes Design, welches Komfort und ein Wohlbefinden ermöglicht.

La structure caractéristique en aluminium extrudé se prolonge dans le fauteuil *armframe* (disponible avec repose-pieds) jusqu'à créer une silhouette sinieuse dans la chaise longue *longframe*. Pour les moments de relax en plein air, les deux sièges donnent au milieu style, harmonie et charme en transmettant un design pratique et élégant visant au bien-être et au confort.

## DIMENSIONS

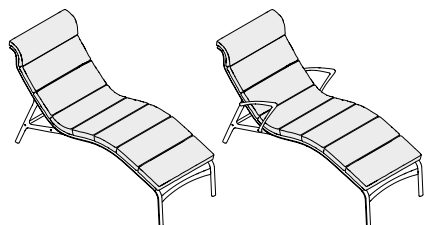

LONGFRAME SOFT 414/415 \*

cm 54x146 - h cm 82 - h seat 42  
cm 66x146 - h cm 82 - h seat 42

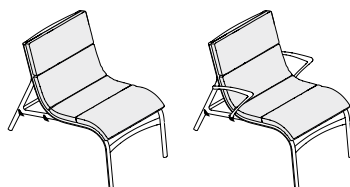

ARMFRAME SOFT 462/463 \*

cm 54x91 - h cm 73 - h seat 41  
cm 66x91 - h cm 73 - h seat 41



FEETFRAME SOFT / 464 \*

cm 54x55 - h cm 41



\*AVAILABLE FOR OUTDOOR

# FRAME LOUNGE OUTDOOR



LONGFRAME



ARMFRAME / FEETFRAME



ARMFRAME SOFT OUTDOOR

In the outdoor version seat and back in mesh, removable and draining cushion.  
Nella versione outdoor seduta e schienale in rete con cuscino removibile e drenante.

## DIMENSIONS

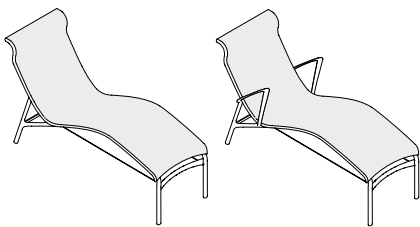

LONGFRAME 419\_O/439\_O

cm 54x146 - h cm 82 - h seat 42  
cm 66x146 - h cm 82 - h seat 42

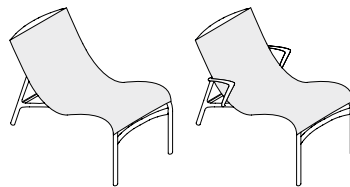

ARMFRAME 418\_O/419\_O

cm 54x91 - h cm 73 - h seat 38  
cm 66x91 - h cm 73 - h seat 38



FEETFRAME / 431\_O

cm 54x55 - h cm 38

# FLOATINGFRAME



*Floatingframe*: sistema di sedute su barra con struttura in alluminio verniciato o lucidato; sedute *bigframe* con o senza braccioli con rete ignifuga di poliestere spalmata di PVC, in tessuto o pelle. Disponibile fino a 6 sedute.

*Floatingframe*: beam seating system with structure in lacquered or polished aluminium; seat *bigframe* with or without arms, covered with fire retardant PVC covered polyester mesh, fabric or leather. Available up to 6 seats.

*Floatingframe*: Sitzsystem auf Tragestruktur mit Gestell aus lackiertem oder poliertem Aluminium; *Bigframe*-Sitze mit oder ohne Armlehnen, bezogen mit feuerhemmendem PVC-beschichtetem Polyesternetzgewebe, Stoff oder Leder. Bis zu 6 Sitzen erhältlich.

*Floatingframe* : système de sièges sur poutre avec structure en aluminium laqué ou poli ; sièges *bigframe* avec ou sans accoudoirs avec tissu polyester maille ignifuge enduit de PVC, en tissu ou en cuir. Disponible jusqu'à 6 sièges.

## DIMENSIONS

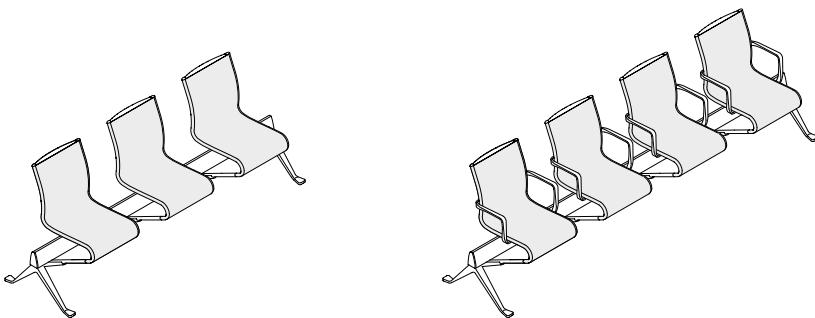

FLOATINGFRAME / BA3

cm 220x69 - h cm 87 - seat h cm 46

A seconda del numero di sedute saranno presenti 2 o 3 gambe.  
Depending on the number of seats there will be 2 or 3 feet.  
Je nach Anzahl der Sitze gibt es 2 oder 3 Füße.  
Selon le nombre de sièges, il y aura 2 ou 3 pieds.



FLOATINGFRAME TABLE / 450  
cm 60x30





# FRAME COLLECTION FINISHES

## STRUTTURA / STRUCTURE / GESTELL / STRUCTURE

Alluminio lucidato/cromato  
Polished/Chromed Aluminium  
Aluminium poliert/verchromt  
Aluminium poli/chromé



AB

CR

\* Alluminio verniciato goffrato  
Textured lacquered aluminium  
Lackiertes gerauhtes Aluminium  
Aluminium laqué granité



A019

A011

A047

A022

A051

A039

A041

A042

## SEDUTA & SCHIENALE / SEAT & BACK / SITZ & RÜCKENLEHNE / ASSISE & DOSSIER

\* Rete A  
Mesh A  
Netzgewebe A  
Tissu maillé A

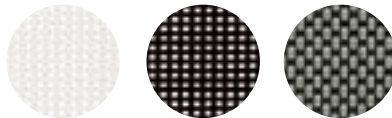

R009

R007

R028

R009 solo per struttura verniciata e cromata.  
R009 only for lacquered and chromed.  
R009 nur auf die lackierten und verchromten Versionen erhältlich.  
R009 seulement pour les versions laquées et chromées.

\* Rete B  
Mesh B  
Netzgewebe B  
Tissu maillé B

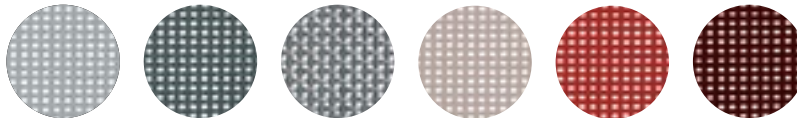

R003

R006

R020

R011

R024

R025

Tessuti  
Fabric  
Stoff  
Tissu

Camira® A  
Xtreme  
Urban

Kvadrat® B  
Maple  
Remix  
Tonus

Kvadrat® C  
Canvas  
Divina  
Foss  
Hallingdal 65  
Hero  
Steelcut  
Steelcut Trio

Ecopelle  
Eco-leather  
Kunstleder  
Simili cuir

Serge Ferrari® / Stamskin Top®



20237

07432

20284

20253

20286

Colour example eco-leather

\* Finiture anche per prodotti outdoor  
Finishes also for outdoor products

FINITURE SOLO PER OUTDOOR  
FINISHES ONLY FOR OUTDOOR

pelle Pelle Frau® SC ColorSphere®  
 Pelle Frau® SC ColorSphere® leather  
 Pelle Frau® SC ColorSphere® leder  
 Cuir Pelle Frau® SC ColorSphere®

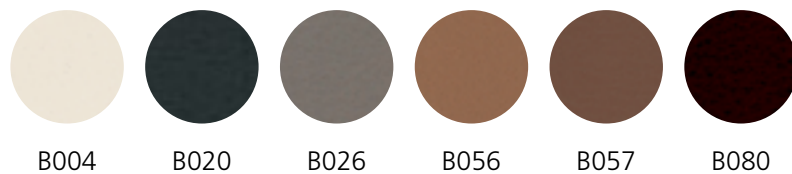

altri colori disponibili su richiesta  
 other colours available on request

B004 solo per struttura verniciata e cromata.  
 B004 only for lacquered and chromed.  
 B004 nur auf die lackierten und verchromten Versionen erhältlich.  
 B004 seulement pour les versions laquées et chromées.

Tessuti  
 Fabric  
 Stoff  
 Tissu

Tempotest® A



Alias® / Living outdoor

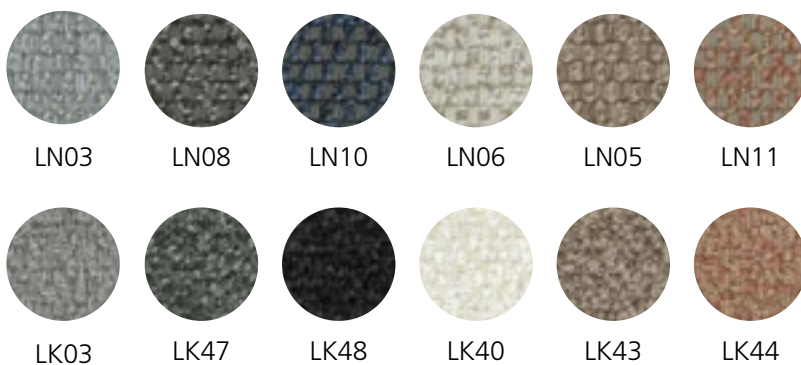

\* Finiture anche per prodotti outdoor  
 Finishes also for outdoor products

FINITURE SOLO PER OUTDOOR  
 FINISHES ONLY FOR OUTDOOR



# KAYAK

PATRICK NORGUET



Il legno è il filo conduttore di *kayak*, la sedia sviluppata con tecnologie tradizionali per dare vita a un progetto di grande eleganza e comfort. *Kayak* è un prodotto tecnicamente complesso, caratterizzato da una seduta accogliente, di grande piacevolezza estetica e altrettanta stabilità.

Holz ist der rote Faden des Stuhlmodells *kayak*, dessen Projekt nach traditioneller Technologie entwickelt wurde und große Eleganz und Sitzkomfort bietet. Dieses technisch komplexe Produkt zeichnet sich durch eine bequeme Sitzfläche, eine sehr angenehme Ästhetik und große Stabilität aus.

Wood is the leitmotif of *kayak*, a chair developed by means of traditional technologies to create a project of great elegance and comfort. *Kayak* is a product of technical complexity, it offers a body-hugging seat, remarkable good looks and equally good stability.

Le bois est le fil conducteur de *kayak*, la chaise développée selon des techniques traditionnelles pour donner naissance à un projet de grand élégance et confort. *Kayak* est un produit complexe sur le plan technique qui se distingue par une assise accueillante, très agréable sur le plan esthétique et extrêmement stable.

# KAYAK



KAYAK



KAYAK SOFT



KAYAK STOOL



The mark of responsible forestry



reddot award 2016  
best of the best furniture design

KAYAK



XXIII COMPASSO D'ORO ADI / KAYAK  
PREMIO MENZIONE D'ONORE  
PRIZE OF HONORABLE MENTION

Kayak / 047 disponibile su richiesta la versione impilabile (fino a 4 sedie).  
Kayak / 047 stackable version available on request (max 4 chairs).  
Kayak / 047 stapelbare Version auf Anfrage erhältlich (bis zu 4 Stapelstühle).  
Kayak / 047 Version empilable disponible sur demande (empilables jusqu'à 4).

## DIMENSIONS



KAYAK / 047

cm 49x53 - h cm 78 - h seat cm 46



KAYAK SOFT / 049

cm 49x53 - h cm 78 - h seat cm 46

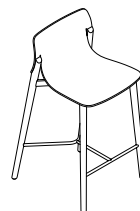

KAYAK STOOL / 051

cm 53x50 - h cm 90 - h seat cm 65

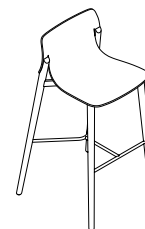

KAYAK HIGH STOOL / 052

cm 55x58 - h cm 105 - h seat cm 80

Pratico e versatile, *kayak stool* è disponibile in due altezze. È proposto in rovere naturale, verniciato rovere scuro o rovere tinto noce e in faggio verniciato a poro aperto.

The practical and versatile *kayak stool* is available in two heights. It is available in natural oak, stained dark or walnut oak and in several coloured stains beechwood variants.

Der praktische und vielseitige *Kayak Stool* ist in zwei Höhen erhältlich. Er wird in Eiche natur, in Eiche dunkel oder Nussbaum gebeizt, oder in verschiedenen offenporig lackierten Buchenvarianten angeboten.

Pratique et polyvalent, *kayak stool* est disponible en deux hauteurs. Il est proposé en chêne naturel, laqué chêne foncé ou chêne teinté noyer et en hêtre laqué à pore ouvert.

## FINISHES

### SEDUTA & SCHIENALE / SEAT & BACK / SITZ & RÜCKENLEHNE / ASSISE & DOSSIER

Essenza  
Wood  
Holzarten  
Bois

Rovere  
Oak  
Eiche  
Chêne

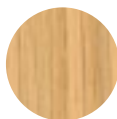

RV

Rovere tinto noce canaletto  
Stained oak canaletto walnut  
Eiche Gebeizt canaletto nußbaum  
Chêne teinté noyer canaletto



NCT

Rovere tinto nero  
Stained Dark oak  
Eiche Gebeizt dunkel  
Chêne teinté foncé

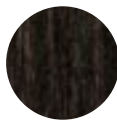

RVT

Verniciatura a poro aperto  
Coloured stains  
Offenporig lackiert  
Laquage à pore ouvert

Faggio  
Beechwood  
Buche  
Hêtre



V131



V140



V142

### CUSCINO / PAD / KISSEN / COUSSIN

Tessuti  
Fabrics  
Stoff  
Tissu

Camira® A  
Xtreme  
Urban

Kvadrat®  
Divina  
Tonus





# KOBI

PATRICK NORGUET



La passione per le tecnologie, la funzionalità e la leggerezza. Valori che uniscono il designer Patrick Norguet e Alias. Un'affinità da cui prende forma *kobi*. Norguet studia una nuova tipologia di seduta, ispirandosi alla tradizione delle sedie in filo di ferro, e progetta una struttura elegante e leggera: un'architettura sospesa di grande contemporaneità.

Leidenschaft für Technologie, Zweckmäßigkeit und Leichtigkeit. Dies sind die Werte, die den Stil des Designers Patrick Norguet und Alias vereinen. Aus dieser Gemeinsamkeit entspringt der Stuhl *kobi*. Norguet entwickelt einen neuen Stuhltyp. Inspiriert durch die Tradition der Drahtgeflechte, entwirft er eine elegante, leichte Struktur: eine Architektur von höchster Aktualität, die frei im Raum zu schweben scheint.

Passion for technology, functionality and lightness are the values shared by the designer Patrick Norguet and Alias. *Kobi* has taken shape as a result of this affinity. Norguet has developed a new type of chair, inspired by the tradition of iron wire chairs, coming up with an elegant and light-weight structure: highly contemporary suspended architecture.

La passion pour les technologies, la fonctionnalité et la légèreté. Des valeurs communes au designer Patrick Norguet et à Alias. Une affinité qui prend la forme de *kobi*. Norguet étudie un nouveau genre d'assise, s'inspirant de la tradition des chaises en fil de fer, et conçoit une structure élégante et légère: une architecture suspendue d'une grande modernité.

# KOBI



KOBI



KOBI WOOD



KOBI + PAD SMALL / MEDIUM / LARGE



KOBI SOFT

Kobi soft / 03A è possibile scegliere due colori e materiali diversi per il rivestimento fronte e retro della seduta.  
Kobi soft / 03A it is possible to choose different colours and materials for front & back of the seat.  
Kobi soft / 03A es ist möglich, verschiedene Farben und Materialien für die Vorder- und Rückseite des Sitzes zu wählen.  
Kobi soft / 03A il est possible de choisir deux couleurs et matériaux différents pour le revêtement intérieur et extérieur de l'assise.

# OVERVIEW

## ACCESSORIES / ACCESSORI

### Cushions - *Cuscini*

in expanded polyurethane upholstered in eco-leather, leather and fabric.

*in poliuretano espanso rivestito in ecopelle, pelle o tessuto.*



PAD LARGE



PAD MEDIUM



PAD SMALL  
(available for outdoor)

**Shell - *Scocca***  
in lacquered steel. Norguet is inspired by the tradition of iron wire chairs.

*in acciaio verniciato.  
Norguet si ispira alla tradizione delle sedie in filo di ferro.*

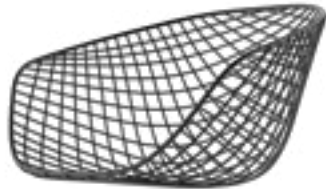

CHAIR



SOFT  
(available only with support belt and legs in lacquered aluminium)

**Shell - *Scocca***  
in polyurethane covered with fabric or leather.

*in poliuretano rivestito in pelle o tessuto.*

### Support belt and legs - *Cintura e gambe*

in lacquered aluminium  
(available for kobi chair and kobi soft).

*in alluminio verniciato  
(disponibile per kobi chair e kobi soft).*



### Support belt and legs - *Cintura e gambe*

support belt in lacquered aluminium  
legs in oak veneered  
(only for kobi chair / 041).

*cintura in alluminio verniciato  
gambe in impiallacciato rovere naturale  
(solo per kobi chair / 041).*



## KOBI SLEDGE



KOBI SLEDGE



KOBI STOOL

La pratica struttura a slitta caratterizza la sedia *kobi sledge* e gli sgabelli *kobi stool*, disponibili in due altezze. Entrambi i modelli, come l'intera collezione *kobi*, hanno seduta composta da intrecci di tondino d'acciaio saldato e prevedono cuscini modellati per aderire perfettamente alla seduta ed integrarsi visivamente con la struttura, garantendo un adeguato livello di comfort.

The practical sledge structure characterises the *kobi sledge* chair and the *kobi stools*, available in two heights. Both models have seats made of welded steel rod, like the entire *kobi* collection and their cushions are shaped to perfectly fit the seat and visually integrate with the structure, ensuring an adequate level of comfort.

Das praktische Kufengestell kennzeichnet den *kobi sledge* Stuhl und den *kobi stool*, Hocker der in zwei Höhen erhältlich ist. Beide Modelle sind wie die gesamte *Kobi*-Kollektion mit Sitzen aus geschweißtem und geflechtem Stahldraht ausgestattet. Die Kissen sind so geformt, dass sie sich perfekt an die Sitzfläche anpassen und sich optisch in die Struktur einfügen, damit ein angemessener Komfort gewährleistet ist.

La structure pratique luge caractérise la chaise *kobi sledge* et les tabourets *kobi stool*, Hocker disponibles en deux hauteurs. Les deux modèles, comme l'ensemble de la collection *kobi*, ont une assise composée de tressage de tiges d'acier soudées et sont dotés de coussins dont la forme s'adapte parfaitement à l'assise et s'intègre visuellement à la structure, garantissant un niveau de confort d'adéquat.

## SOLUTIONS



**KOBI SOFT**  
FINISHES: TEXTURED LACQUERED ALUMINIUM/STEEL (A011) FABRIC KVADRAT@ C  
**MANZÚ TABLE**  
FINISHES: LAQUERED ALUMINIUM (V130) LACQUERED MDF (V130)



**KOBI SOFT**  
FINISHES: TEXTURED LACQUERED ALUMINIUM/STEEL (A011) FABRIC KVADRAT@ C  
**BIPLANE**  
FINISHES: TEXTURED LACQUERED ALUMINIUM (A011) FULL COLOR (FC01)

## DIMENSIONS



KOBI CHAIR / 040 \*

cm 64,5x56 - h cm 76 - h seat cm 42



KOBI WOOD / 041

cm 64,5x56 - h cm 76 - h seat cm 42

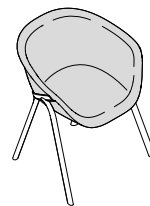

KOBI SOFT / 03A

cm 65x57 - h cm 76 - h seat cm 45



KOBI + PAD SMALL \*



KOBI + PAD MEDIUM

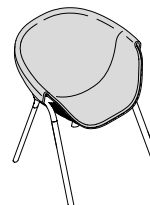

KOBI + PAD LARGE



KOBI SLEDGE / N01 \*

cm 48x52,5 - h cm 86,5 - h seat cm 49



KOBI MEDIUM STOOL / N02 \*

cm 50,5x42 h cm 73 - h seat cm 63,5

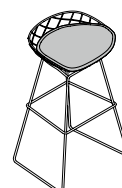

KOBI HIGH STOOL / N03 \*

cm 54x44 - h cm 89 - h seat cm 79,5

I cuscini della collezione *kobi*, realizzati in poliuretano espanso rivestiti in pelle, tessuto o ecopelle, sono modellati per aderire perfettamente alla scocca ed integrarsi visivamente con la struttura. Per *kobi chair* sono disponibili cuscini nelle varianti seduta, seduta più schienale e a scocca intera. Mentre per *kobi sledge* e *kobi stool*, sono previsti cuscini solo per la seduta fissati direttamente alla scocca.

The cushions of the *kobi* collection, in expanded polyurethane, covered with leather, fabric or synthetic leather, are shaped to perfectly fit the seat and visually integrate with the structure. For the *kobi chair* they are available in three different sizes: as seat pad, seat and back cushion or full-body cushion; while for the *kobi sledge chair* and *kobi stool* cushions are only available for the seat and are attached directly to the shell.

Die Kissen der Kollektion *kobi* aus Polyurethanschaum mit Leder-, Stoff- oder Kunstlederbezug sind so geformt, dass sie perfekt zur Schale passen und sich optisch in die Struktur integrieren. Für den Stuhl *kobi* sind Kissen in den Ausführungen Sitz, Sitz und Rücken, sowie komplette Schale erhältlich. Für *kobi sledge* und *kobi stool* sind hingegen nur Sitzkissen erhältlich, die direkt an der Schale befestigt werden.

Les coussins de la collection *kobi*, réalisés en polyuréthane expansé et revêtus en cuir, tissu ou simili cuir, sont façonnés pour s'adapter parfaitement à la coque et s'intégrer visuellement à la structure. Pour *kobi chair*, les coussins sont disponibles en version assise, assise plus dossier et coque complète. Pour *kobi sledge* et *kobi stool*, uniquement des coussins d'assise sont prévus, fixés directement à la coque.

\* AVAILABLE FOR OUTDOOR

# FINISHES

## STRUTTURA / STRUCTURE / GESTELL / STRUCTURE

\* Alluminio/acciaio verniciato gofrato  
Textured lacquered aluminium/steel  
Lackiertes gerauhtes Aluminium/Stahl  
Aluminium/acier laqué granité

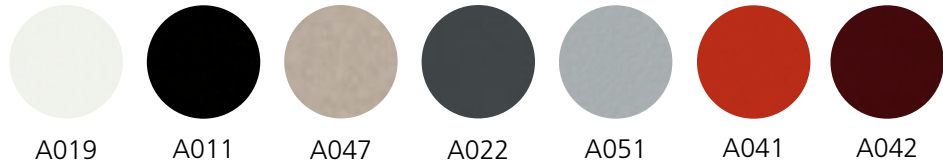

Legno  
Wood  
Holz  
Bois

Rovere  
Oak  
Eiche  
Chêne

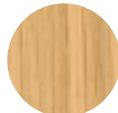

RV

## CUSCINO / PAD / KISSEN / COUSSIN

Tessuti  
Fabric  
Stoff  
Tissu

Alias®  
Living I / II  
Living outdoor

Camira® A  
Xtreme  
Urban

Kvadrat® B  
Remix  
Tonus

Kvadrat® C  
Canvas  
Divina  
Foss  
Hallingdal 65  
Hero  
Steelcut  
Steelcut Trio

\* Ecopelle  
Eco-leather  
Kunstleder  
Simili cuir

Serge Ferrari®  
Stamskin Top®

Tessuti  
Fabric  
Stoff  
Tissu

Tempotest® A



PT01

PT02

PT03

Pelle Pelle Frau® SC ColorSphere®  
Pelle Frau® SC ColorSphere® leather  
Pelle Frau® SC ColorSphere® leder  
Cuir Pelle Frau® SC ColorSphere®

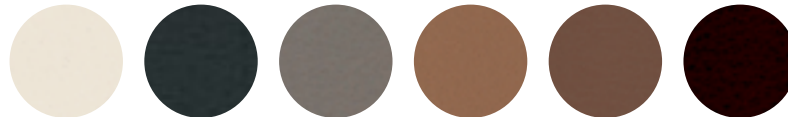

B004

B020

B026

B056

B057

B080

altri colori disponibili su richiesta  
other colours available on request

\* Finiture anche per prodotti outdoor  
Finishes also for outdoor products





# LADY COLLECTION

PAOLO RIZZATTO



La struttura a tre gambe in alluminio pressofuso è l'idea portante di *young lady*.

Accanto alla poltroncina in paglia di Vienna, Paolo Rizzatto propone due sedute avvolgenti abbinabili a diverse basi: *new lady* ha scocca rivestita in cuoio e corredata di confortevoli cuscini; mentre *new lady soft* è caratterizzata da una scocca "soft" in poliuretano rivestita in pelle o tessuto. Le qualità estetiche e funzionali le rendono ideali per le più diverse occasioni d'uso.

Das dreibeinige Gestell aus Aluminiumdruckguss ist die Hauptidee von *young lady*. Neben dem Sessel aus Wienergeflecht bietet Paolo Rizzatto zwei kuschelige Sitze an, die mit verschiedenen Untergestellen kombiniert werden können: *new lady* hat eine Schale bezogen mit Kernleder und mit bequemen Kissen, während *new lady soft* eine „weiche“ Polyurethanschale mit Leder- oder Stoffbezug aufweist. Aufgrund ihrer ästhetischen und funktionalen Qualitäten sind sie ideal für eine breite Palette von Anwendungen.

The three-leg die-cast aluminium frame is the main idea behind *young lady*.

Alongside the armchair with Viennese straw, Paolo Rizzatto offers two cosy seats that can be combined with different bases: *new lady* has a shell upholstered in leather with comfortable cushions, while *new lady soft* features a "soft" polyurethane shell covered in leather or fabric. Their aesthetic and functional qualities make them ideal for a wide range of uses.

La structure à trois pieds en fonte d'aluminium est l'idée principale de *young lady*. Outre le fauteuil en paille, Paolo Rizzatto propose deux sièges enveloppants qui peuvent être combinés avec différentes bases: *new lady* a une coque revêtue en cuir avec des coussins confortables, tandis que *new lady soft* présente une coque "souple" en polyuréthane recouverte de cuir ou de tissu. Leurs qualités esthétiques et fonctionnelles les rendent idéales pour un large éventail d'utilisations.

# LADY COLLECTION



YOUNG LADY



YOUNG LADY SOFT



NEW LADY



NEW LADY SOFT

## OVERVIEW NEW LADY



**pad:** cushion for new lady seat. Cushion with cover in fabric or leather (not removable).

**pad:** *cuscino per sedute new lady. Cuscino rivestito in tessuto o pelle (non sfoderabile).*

**NEW LADY**  
**Seat / Scocca**  
Hide / Cuoio



**NEW LADY**



**NEW LADY SOFT**

**NEW LADY SOFT**

**Seat / Scocca**  
Fabric or leather  
*Tessuto o pelle*

It is possible to choose different colours and materials for front & back of the seat

*È possibile scegliere due colori e materiali diversi per il rivestimento fronte e retro della seduta*



**new lady:** 3-leg base fixed in die-cast aluminium lacquered or polished.

**new lady:** *struttura a 3 razze fissa in alluminio pressofuso verniciato o lucidato.*



**new lady wood:** 4-star base fixed in solid oak wood.

**new lady wood:** *struttura a 4 razze fissa in legno massello di rovere.*



**calyx:** swivel base in lacquered steel.

**calyx:** *base girevole in acciaio verniciato.*

## TREE TABLE



Accanto alle poltroncine girevoli *young lady* e *new lady*, Paolo Rizzatto disegna i tavoli *tree table* disponibili in diversi modelli: il tavolino ad altezza regolabile con piano rotondo arreda con eleganza il living; semplice ma ricercata la versione con piano reniforme dotato di cassetto che si configura come un vero e proprio scrittoio. Entrambi i modelli sono caratterizzati dalla struttura a tre gambe in alluminio pressofuso, idea portante dell'intera collezione.

Besides the *young lady* and *new lady* swivel armchairs, Paolo Rizzatto designs the *tree table*, available in different models: the height-adjustable small table with a round top elegantly furnishes the living room; the version with a kidney-shaped top is simple but refined and it is equipped with a drawer, thus creating a real writing desk. Both models are characterised by the three-leg structure in die-cast aluminium, the main idea behind the entire collection.

Neben den Drehsesseln *young lady* und *new lady* entwirft Paolo Rizzatto die Tische *tree table*, die in verschiedenen Ausführungen erhältlich sind: Der höhenverstellbare kleine Tisch mit runder Platte richtet das Wohnzimmer elegant ein; schlicht und doch raffiniert ist die Version mit nierenförmiger Platte, die mit einer Schublade ausgestattet ist und als echter Schreibtisch dient. Beide Modelle zeichnen sich durch die dreibeinige Struktur aus Aluminiumdruckguss aus, die die Hauptidee der gesamten Kollektion ist.

A côté des fauteuils tournants *young lady* et *new lady*, Paolo Rizzatto dessine les tables *tree table* disponibles en différents modèles: la petite table réglable en hauteur avec plateau rond meuble avec élégance le living; simple mais recherchée la version avec plateau réniforme équipé d'un tiroir qui se configure comme un véritable bureau. Les deux modèles sont caractérisés par la structure à trois pieds en fonte d'aluminium, idée porteuse de toute la collection.

# DIMENSIONS



**YOUNGLADY / 901**

cm 59x59 - h cm 80 - h seat cm 48



**YOUNGLADY SOFT / 901**

cm 59x59 - h cm 80 - h seat cm 50



**NEW LADY / 07A**

cm 59x52 - h cm 88 - h seat cm 48



**NEW LADY WOOD / 07B**

cm 59x52 - h cm 88 - h seat cm 48



**NEW LADY CALYX / 07D**

cm 59x52 - h cm 88 - h seat cm 48

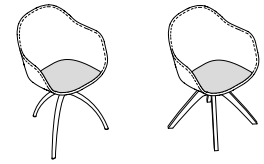

**NEW LADY PAD / 07C**



**NEW LADY SOFT / 07E**

cm 58x52 - h cm 80 - h seat cm 48



**NEW LADY SOFT WOOD / 07F**

cm 58x52 - h cm 80 - h seat cm 48



**NEW LADY SOFT CALYX / 07G**

cm 58x52 - h cm 80 - h seat cm 48



**TREE TABLE / 909**

cm 160x85 - h cm 73

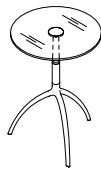

**TREE TABLE / 950**

cm Ø 60 - h cm 55-70

## INTERIOR SOLUTION



### NEW LADY

FINISHES: WOOD (RV) HIDE (C003)

### MANZÚ TABLE

FINISHES: LAQUERED ALUMINIUM (A019) LACQUERED MDF (V001) MARBLE BIANCO DI CARRARA (MA01)

## FINISHES TABLES

### Tree table / 909

Alluminio lucidato  
Polished aluminium  
Aluminium poliert  
Aluminium poli



AB

Impiallacciato  
Veneered  
Furnierung  
Plaqué

Frassino naturale  
Natural Ash  
Esche natur  
Frêne naturel



TFRN

### Tree table / 950

Alluminio verniciato liscio  
Smooth lacquered aluminium  
Aluminium lackiert glatt  
Aluminium laqué lisse



A009

Cristallo trasparente  
Transparent glass  
Durchsichtiges Glas  
Verre transparent



# FINISHES CHAIRS

## STRUTTURA / STRUCTURE / GESTELL / STRUCTURE

Alluminio lucidato  
Polished aluminium  
Aluminium poliert  
Aluminium poli



AB

Alluminio/acciaio verniciato goffrato  
Textured lacquered aluminium/steel  
Lackiertes gerauhtes Aluminium/Stahl  
Aluminium/acier laqué granité



A019



A011



A047



A022



A051

Legno  
Wood  
Holz  
Bois

Rovere  
Oak  
Eiche  
Chêne

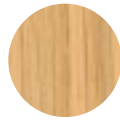

RV

Rovere grigio cenere  
Ash grey oak  
Eiche aschgrau  
Chêne gris cendré



RC

solo per New Lady Wood  
only for New Lady Wood  
nur für New Lady Wood  
uniquement pour New Lady Wood

Frassino naturale  
Natural Ash  
Esche natur  
Frêne naturel



TFRN

solo per Young Lady  
only for Young Lady  
nur für Young Lady  
uniquement pour Young Lady

Verniciatura a poro aperto  
Coloured stains  
Offenporig lackiert  
Laquage à pore ouvert



V140

solo per New Lady Wood  
only for New Lady Wood  
nur für New Lady Wood  
uniquement pour New Lady Wood

## SCOCCA / SHELL / SITZSCHALE / COQUE

Paglia di Vienna  
Viennese Straw  
Wiener Geflecht  
Paille



Paglia

solo per YoungLady  
only for YoungLady  
nur für YoungLady  
uniquement pour YoungLady

Cuoio  
Hide  
Kernleder  
Cuir sellier



C011



C012



C003

Tessuti  
Fabric  
Stoff  
Tissu

Alias®  
Living I / II

Kvadrat® B  
Maple  
Remix  
Tonus

Kvadrat® C  
Canvas  
Divina  
Hallingdal 65  
Harald

Kvadrat® C  
Hero  
Steelcut  
Steelcut trio  
Twill weave

Pelle Pelle Frau® SC ColorSphere®  
Pelle Frau® SC ColorSphere® leather  
Pelle Frau® SC ColorSphere® Leder  
Cuir Pelle Frau® SC ColorSphere®



B004



B020



B026



B056



B057

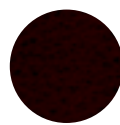

B080

altri colori disponibili su richiesta  
other colours available on request





# LALEGGERA

RICCARDO BLUMER



Massima espressione di tecnologia applicata al design, *laleggera* è una seduta che nasce dall'incontro tra un solido materiale della tradizione, il legno massello, e il più contemporaneo e leggero poliuretano espanso di cui la struttura è riempita. Il rivestimento in piallacci di legno incollati o in tranciato di legno multilaminare è rifinito con verniciatura trasparente o laccatura in vari colori. Nel 2009 il progetto è entrato a far parte della collezione permanente del MoMA di New York.

Höchster Ausdruck der Technologie und Forschung ist die *laleggera* Kollektion. Das ist Ergebnis das einer Kombination von solidem und traditionellem Material Massivholz, und von modernem und leichtem Polyurethanschaum, der in die Struktur gespritzt wird. Die Verkleidung mit Holzfurnier oder Schichtholzplatten kann mit transparentem oder farbigem Lack gestaltet werden. Im Jahr 2009 wurde *laleggera* in die permanente Kollektion des MoMA in New York aufgenommen.

*Laleggera* collection is the expression of research and technology at its maximum: it's the result of combining a solid traditional material, solid wood, with the lightest, expanded polyurethane, injected in the structure. The external shell in different wood veneers or sliced veneer multilaminare is available with a transparent varnish finish or various lacquer colours. In 2009 it became part of the permanent MoMA collection in New York.

À la pointe de la recherche et de la technologie, la collection *laleggera* est le fruit de la rencontre entre un matériau solide de tradition, le bois massif, et d'une matière plus moderne et légère, le polyuréthane expansé, dont la structure est remplie. Le revêtement en placage de bois collé ou de bois multilaminaire tranché, peut être fini avec un verni transparent ou laqué dans différents coloris. En 2009 elle est entrée dans la collection permanente du MoMA de New York.

# LALEGGERA



LALEGGERA CHAIR LEATHER / LALEGGERA CHAIR



LALEGGERA ARMREST



LALEGGERA CHAIR+ LEATHER / LALEGGERA CHAIR+



LALEGGERA BENCH / STOOL / LITTLE STOOL

Accanto alle sedie, con e senza braccioli, declinazioni del concetto di leggerezza sono sgabelli e panche. Lo stesso materiale, le stesse finiture e la stessa purezza di linee tornano in questi pezzi, progettati per essere accoglienti, ergonomici e funzionali, proposti con impiallacciatura in varie essenze o laccatura a poro aperto in svariati ed attuali colori.

In addition to chairs, with and without arms, stools and benches add a different dimension to the concept of "lightness". The same material, the same finishes and the same pure lines are back in the new pieces, designed to be cosy, ergonomic and practical, offered with veneer in different type of wood or a variety of coloured stains.

Neben Stühlen mit oder ohne Armlehnen, sind die Hocker und Bänke eine Interpretation des Begriffs der Leichtigkeit. Bei diesen Objekten werden das gleiche Material und die gleiche Reinheit in der Linienführung wieder aufgenommen und vermitteln Gemütlichkeit, Ergonomie und Zweckmäßigkeit. Erhältlich in verschiedenen Holzfurniere oder gebeizt in verschiedenen Farben.

Avec les chaises, sans et avec accoudoirs, tabourets et bancs sont déclinaisons du concept de légèreté. Le même matériau, les mêmes finitions et la même pureté se retrouvent dans ces pièces, projetées pour être accueillantes, ergonomiques et fonctionnelles, proposées avec placage de différentes essences ou laquage à pore ouvert en plusieurs coloris actuels.

## INTERIOR SOLUTIONS



**LALEGGERA**  
FINISHES: COLOURED STAINS (V131)  
**TEC 1000**  
FINISHES: TEXTURED LACQUERED ALUMINIUM (A019) FULL COLOR (FC01)



**LALEGGERA**  
FINISHES: OAK (RV)  
**ILVOLO**  
FINISHES: OAK (RV)

# DIMENSIONS



LALEGGERA CHAIR / LEATHER / 301

cm 36x49 - h cm 79 - h seat cm 46



LALEGGERA CHAIR + / LEATHER / 316

cm 40x49 - h cm 79 - h seat cm 46

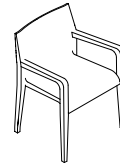

LALEGGERA ARMREST / 304

cm 56x49 - h cm 79 - h seat cm 45

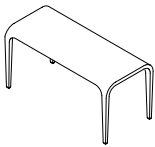

LALEGGERA BENCH / 307

cm 95x41 - h cm 44



LALEGGERA STOOL / 310

cm 36x35 - h cm 44



LALEGGERA LITTLE STOOL / 315

cm 30x31 - h cm 30

The seats 301 and 316 are stackable up to 6. Laleggera stool and little stool are stackable up to 5.

*Le sedute 301 e 316 sono impilabili fino a 6. Laleggera stool e little stool sono impilabili fino a 5.*



Laleggera chair carrying trolley in lacquered steel, for up to 20 chairs 301.

*Carrello porta-sedie laleggera in acciaio verniciato, porta fino a 20 sedie 301.*



Linking device in chromed steel for seats 301 (to be used for chairs with coupling link).

*Giunto di collegamento in acciaio cromato per sedute 301 (da utilizzare su sedute preposte per l'attacco giunto).*

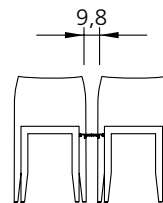
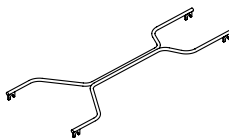

Scopri come viene prodotta la seduta **laleggera**  
Find out how the **laleggera** seat is produced



XXIII COMPASSO D'ORO ADI / LALEGGERA CHAIR  
PREMIO MENZIONE D'ONORE  
PRIZE OF HONORABLE MENTION

## FINISHES

Legno  
Wood  
Holz  
Bois

Acero naturale  
Natural maple  
Ahorn natur  
Erable naturel



ACN

Rovere  
Oak  
Eiche  
Chêne



RV

Rovere tinto  
Stained oak  
Eiche gebeizt  
Chêne teinté

Rovere noce canaletto  
Canaletto walnut oak  
Eiche canaletto nußbaum  
Chêne noyer canaletto



NCT

Rovere sbiancato  
White oak  
Eiche gebleicht  
Chêne blanchi



RVS

Rovere grigio cenere  
Ash grey oak  
Eiche aschgrau  
Chêne gris cendré

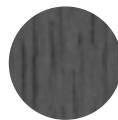

RC

Verniciatura a poro aperto  
Coloured stains  
Offenporig lackiert  
Laquage à pore ouvert



V131



V140



V142

### LALEGGERA LEATHER

Ecopelle  
Eco-leather  
Kunstleder  
Simili cuir



EC01



EC02



EC03



EC04

Pelle Pelle Frau® SC ColorSphere®  
Pelle Frau® SC ColorSphere® leather  
Pelle Frau® SC ColorSphere® leder  
Cuir Pelle Frau® SC ColorSphere®



B004



B020



B026



B056



B057

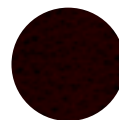

B080

altri colori disponibili su richiesta  
other colours available on request

*Laleggera chair*, Compasso d'Oro ADI 1998, è un pezzo-icona esposto al MoMA di New York, al Centre George Pompidou di Parigi e alla Triennale di Milano. Un segno semplice ed essenziale. Una seduta maneggevole, resistente e impilabile che coniuga leggerezza visiva e strutturale, grazie al materiale con il quale si realizzano gli alianti: legno con supporto interno in poliuretano iniettato.

The *laleggera chair*, was awarded the "Compasso d'Oro ADI" prize in 1998 and it is an iconic piece, displayed at the New York MoMA, at the Centre George Pompidou in Paris and at the Milan Triennale. A simple and essential symbol. This practical, resistant and stacking chair combines visual and structural lightness thanks to the material used to make the "gliders": wood injected with polyurethane foam.

Der *laleggera* Stuhl, eine Design-ikone, die 1998 mit dem Design-Preis "Compasso d'Oro ADI" ausgezeichnet wurde, ist heute im MoMA in New York, im Centre Pompidou in Paris, sowie bei der Triennale in Mailand ausgestellt. Ein einfaches und essentielles Zeichen. Es ist ein handlicher, robuster und stapelbarer Stuhl, der strukturelle und visuelle Leichtigkeit vermittelt. Eingesetzt wird ein innovatives Verfahren, nach dessen Prinzip auch Gleitflugzeuge hergestellt werden: Holz mit eingespritztem Polyurethankern.

La chaise *laleggera*, Compasso d'Oro ADI 1998, est véritable icône exposée au MoMA de New York, au Centre Georges Pompidou de Paris et à la Triennale de Milan. Un signe simple et essentiel. Une assise maniable, résistante et empilable qui conjugue légèreté visuelle et structurelle, grâce au matériau utilisé pour fabriquer les planeurs: du bois avec une âme en polyuréthane injecté.



# SLIM COLLECTION

PEARSONLLOYD



Il duo britannico PearsonLloyd disegna per Alias la collezione di sedute da lavoro *slim*. Linee leggere, profili sottili e imbottiture con bordi morbidi ed allungati, sono gli elementi che caratterizzano l'intera collezione. Luke Pearson e Tom Lloyd creano così una collezione ultra contemporanea, caratterizzata da pezzi di estrema leggerezza formale e grandissimo comfort, con lo scopo di offrire agli architetti un progetto trasversale ideale per soddisfare la richiesta più specifica.

Das britische Planer-Duo PearsonLloyd entwirft für Alias die Arbeitsstuhl-Kollektion *slim*. Leichte, Linien, feine Profile und Polster mit weichen, langgezogenen Saumen, sind die typischen Elemente der gesamten Kollektion. Luke Pearson und Tom Lloyd schaffen so eine höchst moderne Kollektion, die sich durch leichteste Formen und einen sehr großen Komfort auszeichnet und den Architekten ein übergreifendes Projekt bietet mit welcher auch die speziellsten Ansprüche zufriedenstellend werden können.

The British design consultancy PearsonLloyd designed the *slim* collection for Alias. Finely drawn lines, slender profiles and padding with soft extended edges are the characterizing elements of the entire collection. Luke Pearson and Tom Lloyd have therefore designed a highly contemporary collection, defined by elements of extreme formal lightness and elevated comfort, with the intent to offer architects an ideal and versatile project to satisfy all requirements, no matter how specific.

Le duo de concepteurs britanniques PearsonLloyd dessinent pour Alias la collection de chaises de travail *slim*. Des lignes légères, des profils minces et des rembourrages aux bords arrondis et allongés: tels sont les éléments qui caractérisent l'ensemble de cette collection. Luke Pearson et Tom Lloyd ont donné naissance à une collection ultra-moderne, caractérisée par des éléments d'une extrême légèreté formelle et d'un grand confort, en vue d'offrir aux architectes un projet transversal, capable de répondre aux exigences les plus diverses.

## SLIM CONFERENCE



SLIM CONFERENCE MEDIUM 4



SLIM CONFERENCE MEDIUM 5



SLIM CONFERENCE HIGH 4



SLIM CONFERENCE HIGH 5

Le sedute *slim conference*, ideali per svariati utilizzi, sono dotate di meccanismo armonico oscillante con una leva che consente il blocco e la regolazione dell'altezza. Seduta e schienale sono realizzati in un unico pezzo. La scocca, rivestita in ecopelle, tessuto o pelle, è proposta in due dimensioni, con schienale medio o alto. Le sedute *slim conference* possono essere dotate di base a quattro razze con piedini non regolabili o a cinque razze con ruote.

*Slim conference* chairs are ideal for a variety of uses and are equipped with a harmonious tilting mechanism with a lever for locking and height adjustment. The seat and the backrest are a whole piece. The shell is upholstered in fabric, eco-leather or leather and is available in two sizes, with a medium or high backrest. The *slim conference* chairs can have a four-star base with non-adjustable feet or a five-star base with castors.

Die *slim conference* Stühle sind mit Kippmechanismus ausgestattet, mit einem Hebel zur Arretierung und Höhenverstellung. Der Sitz und die Rückenlehne sind aus einem einzigen Stück gefertigt. Die mit Stoff, Leder oder Kunstleder bezogene Schale ist in zwei Größen erhältlich, mit mittlerer oder hoher Rückenlehne. Die *slim conference* Stühle sind entweder mit einem 4-Sternausleger mit nicht verstellbaren Füßen oder mit einem 5-Sternausleger mit Rollen erhältlich.

Les chaises *slim conference*, idéales pour diverses utilisations, sont équipées d'un mécanisme harmonique oscillant avec un levier pour bloquer et régler la hauteur. L'assise et le dossier sont réalisés en une seule pièce. La coque, revêtue en simili cuir, tissu ou en cuir, est proposée en deux dimensions, avec dossier moyen ou haut. Les fauteuils *slim conference* sont disponibles avec une base à quatre branches avec pieds non réglables ou une base à cinq branches avec roulettes.



# OVERVIEW

All seats of Slim collection (except Slim lounge low) can be accompanied with "T" or "Y" shaped arms made of aluminium lacquered, polished or chromed. The shaped arms are always offered in the same colour as the base finish.

*Tutte le sedute della collezione (eccetto Slim lounge low) possono essere corredate con braccioli a "T" o a "Y" realizzati in alluminio verniciato, lucidato o cromato, entrambi proposti sempre in tinta alla finitura della base.*



Structure made of die cast aluminium with soft breaking or hard castors, height adjustable and 5-star swivel base with tilt mechanism. Height adjustable seat, piston excursion is 10 cm.

*Base in alluminio pressofuso su ruote autofrenanti morbide o rigide, ad altezza regolabile con base girevole a 5 razze e con meccanismo tilt. Seduta regolabile in altezza, escursione del pistone è di 10 cm.*

Seat swivel with 4-star base 73 cm diameter with tilt mechanism.

Structure made of die cast aluminium lacquered, polished or chromed. Height adjustable seat.

*Base girevole a 4 razze diametro 73 cm con meccanismo tilt. Base in alluminio pressofuso verniciato, lucidato o cromato. Seduta regolabile in altezza.*

Seat shell made of printed polyurethane and metal frame covered with eco-leather, fabric or leather.

*Scocca leggera e continua realizzata in poliuretano stampato e struttura in metallo rivestita in ecopelle, tessuto o pelle.*



## Slim conference medium / high

medium: cm 73x43 - h cm 102/112 - h cm seat 44/54  
high: cm 73x40 - h cm 118/128 - h cm seat 44/54



## SLIM LOUNGE



SLIM LOUNGE HIGH



SLIM LOUNGE LOW



SLIM POUF

Le poltrone *slim lounge* completano la collezione. Caratterizzate da scocche continue e leggere, hanno base a 4 razze dotate di autoritorno. Ideali per i tempi di attesa e relax, *slim lounge* è disponibile nella versione low, con schienale basso e ampia seduta, e nella variante high, con uno schienale alto ed una seduta più raccolta.

*Slim lounge* armchairs complete the collection. They are characterised by continuous, lightweight shells and have a 4-star base with self-adjusting mechanism. *slim lounge* is ideal for waiting and relaxing and is available in the low version with a lower backrest and a wide seat, and in the high version with a higher backrest and a cosier seat.

Die *slim lounge* Sessel vervollständigen die Kollektion. Sie zeichnen sich durch durchgehende, leichte Schalen aus und verfügen über einen 4-Sternausleger mit Rückholmechanik. *Slim lounge* ist ideal zum Warten und Entspannen und ist sowohl in der low Version mit niedriger Rückenlehne und breitem Sitz erhältlich als auch in der high Version mit hoher Rückenlehne und gemütlicherem Sitz.

Les fauteuils *slim lounge* complètent la collection. Caractérisés par des coques continues et légères, ils ont une base à 4 branches avec un mécanisme autotournant. Idéal pour les temps d'attente et de détente, *slim lounge* est disponible dans la version low, avec dossier bas et une assise large, et dans la version high, avec un dossier haut et une assise plus intime.

## INTERIOR SOLUTIONS



**SLIM CONFERENCE HIGH**  
FINISHES: TEXTURED LACQUERED ALUMINIUM (A019) FABRIC KVADRAT@  
**SLIM CHAIR**  
FINISHES: TEXTURED LACQUERED ALUMINIUM/STEEL (A019) POLYPROPYLENE (PP01)  
**FRAMETABLE**  
FINISHES: TEXTURED LACQUERED ALUMINIUM (A019) LAMINATE (L010)



**SLIM LOUNGE LOW**  
FINISHES: TEXTURED LACQUERED ALUMINIUM (A011) FABRIC KVADRAT@ B  
**E LA NAVE VA**  
FINISHES: OAK (RV) FABRIC LIVING I  
**DRY LOW TABLE**  
FINISHES: TEXTURED LACQUERED ALUMINIUM (A051) GLASS (VTT)

# DIMENSIONS



SLIM CONFERENCE MEDIUM / 807

cm 43x73 - h cm 90 ↔ 100 - h seat cm 44 ↔ 56

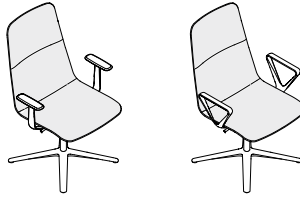

SLIM CONFERENCE MEDIUM / 808



SLIM CONFERENCE MEDIUM / 823

cm 43x73 - h cm 90 ↔ 100 - h seat cm 44 ↔ 56

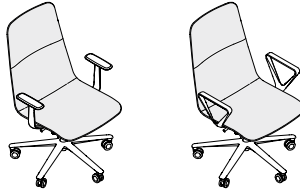

SLIM CONFERENCE MEDIUM / 824

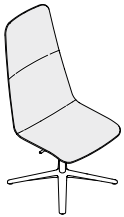

SLIM CONFERENCE HIGH / 812

cm 40x73 - h cm 110 ↔ 120 - h seat cm 44 ↔ 56

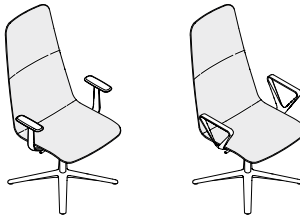

SLIM CONFERENCE HIGH / 813

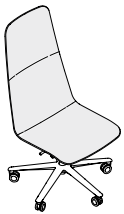

SLIM CONFERENCE HIGH / 825

cm 40x73 - h cm 110 ↔ 120 - h seat cm 44 ↔ 56



SLIM CONFERENCE HIGH / 826



SLIM LOUNGE HIGH / 817

cm 53x85 - h cm 100 - h seat cm 40

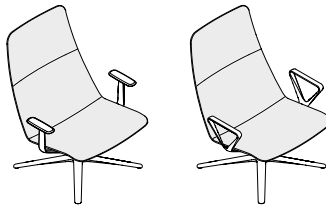

SLIM LOUNGE HIGH / 818



SLIM LOUNGE LOW / 809

cm 69x85 - h cm 70 - h seat cm 40



SLIM POUF / 799

cm 68x53 - h cm 40

## FINISHES

### STRUTTURA / STRUCTURE / GESTELL / STRUCTURE

Alluminio lucidato/cromato  
Polished/Chromed Aluminium  
Aluminium poliert/verchromt  
Aluminium poli/chromé



AB

CR

Alluminio verniciato goffrato  
Textured lacquered aluminium  
Lackiertes gerauhtes Aluminium  
Aluminium laqué granité



A019

A011

A047

A022

A051

### SCocca / SHELL / SITZSCHALE / COQUE

Tessuti  
Fabric  
Stoff  
Tissu

**Camira® A**  
Xtreme  
Urban

**Kvadrat® B**  
Remix  
Tonus

**Kvadrat® C**  
Canvas  
Divina  
Foss  
Hallingdal 65  
Hero  
Steelcut  
Steelcut Trio

Ecopelle  
Eco-leather  
Kunstleder  
Simili cuir

**Serge Ferrari®**  
Stamskin Top®

Pelle Pelle Frau® SC ColorSphere®  
Pelle Frau® SC ColorSphere® leather  
Pelle Frau® SC ColorSphere® Leder  
Cuir Pelle Frau® SC ColorSphere®



B004

B020

B026

B056

B057

B080

altri colori disponibili su richiesta  
other colours available on request



# SLIM CHAIR

PEARSONLLOYD



Dalla collezione di sedute *slim* progettata dal duo britannico PearsonLloyd, nasce *slim chair*. Essenziale ed ergonomica, interpreta perfettamente il tema del design della seduta elementare contemporanea. *Slim chair* è una famiglia che nasce dalla ricerca di una seduta universale e flessibile da inserire facilmente in diversi contesti, dagli uffici al contract, fino alle residenze private.

Aus der Stuhlkollektion *slim* des britischen Duos PearsonLloyd entsteht der neue *slim chair*. Essentiell und ergonomisch, interpretiert *slim chair* perfekt das Thema des zeitgenössischen elementaren Sitzdesigns. Die Produktfamilie *Slim chair* entstand aus der Recherche eines universellen, flexiblen Stuhls, der für unterschiedliche Bereiche geeignet ist: von Büros und Objektbereiche bis zum privaten Wohnraum.

The *slim* collection of seats designed by the British duo PearsonLloyd acquires *slim chair*. Essential and ergonomically designed, the new creation interprets most effectively the theme of the quintessential contemporary seat. *Slim chair* is a family born of the search for a universal and flexible seat that can be used in different contexts, from the office to easily be contract, and even in private residences.

*Slim chair* naît de la collection de sièges *slim* du projet du duo britannique PearsonLloyd. Essentiel et ergonomique, elle interprète parfaitement le thème du design de l'assise élémentaire contemporaine. *Slim chair* est une gamme née de la recherche d'une assise universelle et flexible à intégrer aisément dans différents environnements, des bureaux au contract, jusqu'aux résidences privées.

## SLIM CHAIR



SLIM CHAIR 4



SLIM CHAIR 4 ARM



SLIM CHAIR WOOD



SLIM CHAIR SLEDGE



SLIM CHAIR SLEDGE ARM



SLIM CHAIR STUDIO 4

La scocca in polipropilene è realizzata attraverso uno stampo che, oltre a consentire un'alta tenuta strutturale coniugata a spessori ridotti al limite, permette una minima percentuale di fibra di vetro di rinforzo, garantendo così un'ottima qualità superficiale.

The shell in polypropylene is made with a mould that ensures high structural strength combined with thickness values reduced to the very minimum, and requires a minimal percentage of glass fibre reinforcement, making for optimal surface quality.

Die Struktur aus Polypropylen ist formgepresst und bietet festen Halt in Kombination mit maximal verringerter Dicke und einen minimalen Anteil an verstärkender Glasfaser, wodurch eine optimale Oberflächenqualität garantiert wird.

La coque en polypropylène est réalisée à partir d'un moule que en plus d'assurer une grande tenue structurale combinée à des épaisseurs réduites au maximum, il permet un taux minimal de fibre de verre de renfort garantissant une excellente qualité de surface.



## SLIM CHAIR SOFT



SLIM CHAIR 4 SOFT M



SLIM CHAIR 4 ARM SOFT S



SLIM CHAIR WOOD SOFT L



SLIM CHAIR STUDIO 5 SOFT L

Combinando la scocca con le basi in legno a quattro gambe, o con le strutture in acciaio a quattro gambe o slitta con o senza braccioli, oppure con le versioni studio (regolabili in altezza), la collezione *slim chair* rivela estrema flessibilità attraverso un segno leggero, di grande personalità.

Combining the shell with the four-leg wooden base, or with the 4-leg or sledge steel base with or without armrests, or with the studio versions, the *slim chair* collection reveals extremely high flexibility through a light touch and great personality.

Durch die Kombination der Schale mit Vierfußgestellen aus Holz, mit Vierfußgestellen oder Kufengestellen aus Stahl mit oder ohne Armlehnen, oder mit den studio Versionen (höhenverstellbar), zeigt die *slim chair* Kollektion extreme Flexibilität durch ein leichtes Zeichen mit großer Persönlichkeit.

Associant la coque aux piètements à quatre pieds en bois, ou aux structures à quatre pieds en acier ou en traineau avec ou sans accoudoirs, ou bien aux modèles studio (réglables en hauteur), la collection *slim chair* révèle une extrême flexibilité à travers un signe léger de grande personnalité



Scopri la collezione completa su [alias.design](https://alias.design)  
Discover the complete collection on [alias.design](https://alias.design)

# OVERWIEV

Ergonomic shell in monochromatic polypropylene, made with a mould that allow a minium percentage of glass fiber reinforcement.

*Scocca ergonomica in polipropilene monocolore, realizzata attraverso uno stampo che permette una minima percentuale di fibra di vetro di rinforzo.*

*SLIM CHSIR SOFT  
Ergonomic shell in polypropylene upholstered with cover in fabric, leather o eco-leather.*

*SLIM CHSIR SOFT  
Scocca ergonomica in polipropilene imbottita e rivestita in tessuto, pelle o ecopelle.*



SLIM CHAIR



SLIM CHAIR SOFT PAD S



SLIM CHAIR SOFT PAD M



SLIM CHAIR SOFT PAD L



slim chair 4 \*



slim chair 4 arm \*



slim chair sledge \*

The shell can be combined with bases sledge or 4 legs in stove enamelled, chromed steel slitta or wood and the steel frame.

*La seduta può essere combinata con basi a slitta o a quattro gambe in acciaio verniciato o cromato, o a quattro gambe in legno massello di rovere e telaio in acciaio verniciato.*



slim chair sledge arm



slim chair wood



The mark of responsible forestry



slim chair studio 5



slim chair studio 4



**\*structure stackable, up to a total of 10 chairs.**  
Available only for Slim chair sledge, 4 and 4 arm structure. A stackable version for SOFT seating is available on request.

**\*struttura impilabile, fino ad un totale di 10 sedie.**  
Disponibile solo per struttura Slim chair sledge, 4 e 4 arm. Su richiesta è disponibile la versione impilabile per le sedute SOFT.



Carrello porta-sedie (89X) in acciaio verniciato (A022) per sedie Slim chair (89C, 89F, 89G, 89A, 89H). Porta fino a 15 sedie con scocca in polipropilene e fino a 5 con rivestimento in tessuto o pelle.

Chair carrying trolley (89X) in lacquered steel (A022) for slim chairs (89C, 89F, 89G, 89A, 89H).

For up to 15 chairs with shell in polypropylene and up to 5 chairs with upholstery in fabric or leather.

## INTERIOR SOLUTIONS



**SLIM CHAIR SLEDGE ARM**  
FINISHES: STEEL (CR) POLYPROPYLENE (PP01)  
**FRAMETABLE 498**  
FINISHES: ALUMINIUM (AB) WOOD (RV)



**SLIM CHAIR SOFT**  
FINISHES: TEXTURED LACQUERED STEEL (A019) FABRIC KVADRAT® B  
**BIPLANE**  
FINISHES: TEXTURED LACQUERED ALUMINIUM (A019) LAMINATE (L010)

# DIMENSIONS

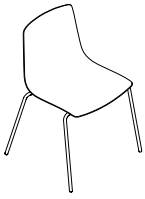

SLIM CHAIR 4 / 89C \*

cm 56x53 - h cm 81 - h seat cm 46



SLIM CHAIR 4 ARM / 89D

cm 56x53 - h cm 81 - h seat cm 46

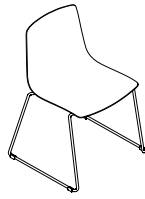

SLIM CHAIR SLEDGE / 89A

cm 55x50 - h cm 80 - h seat cm 46

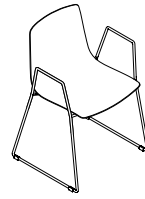

SLIM CHAIR SLEDGE ARM / 89B

cm 55x50 - h cm 80 - h seat cm 46

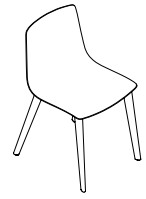

SLIM CHAIR WOOD / 89E

cm 45x52 - h cm 80 - h seat cm 46



SLIM CHAIR STUDIO 5 / 89N

cm ø 72 - seat cm 39x45 -  
h cm 75 ↔ 85 - h seat cm 42 ↔ 52

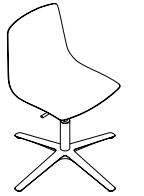

SLIM CHAIR STUDIO 4 / 89Q

cm ø 72 - seat cm 39x45 -  
h cm 72 ↔ 84 - h seat cm 39 ↔ 51



SLIM CHAIR 4 SOFT S / 89C\_S

cm 56x53 - h cm 81 - h seat cm 47



SLIM CHAIR 4 ARM SOFT S / 89D\_S

cm 56x53 - h cm 81 - h seat cm 47



SLIM CHAIR SLEDGE SOFT S / 89A\_S

cm 55x50 - h cm 80 - h seat cm 47

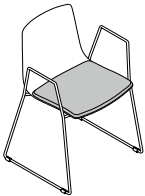

SLIM CHAIR SLEDGE ARM SOFT S / 89B\_S

cm 55x50 - h cm 81 - h seat cm 47



SLIM CHAIR WOOD SOFT S / 89E\_S

cm 45x52 - h cm 80 - h seat cm 47



SLIM CHAIR STUDIO 5 SOFT S / 89N\_S

cm ø 72 - seat cm 39x45 -  
h cm 75 ↔ 85 - h seat cm 44 ↔ 54



SLIM CHAIR STUDIO 4 SOFT S / 89Q\_S

cm ø 72 - seat cm 39x45 -  
h cm 72 ↔ 84 - h seat cm 41 ↔ 53



SLIM CHAIR 4 SOFT M / 89C\_M

cm 56x53 - h cm 81 - h seat cm 47



SLIM CHAIR 4 ARM SOFT M / 89D\_M

cm 56x53 - h cm 81 - h seat cm 47



SLIM CHAIR SLEDGE SOFT M / 89A\_M

cm 55x50 - h cm 80 - h seat cm 47

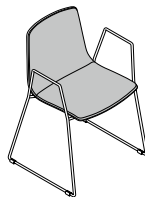

SLIM CHAIR SLEDGE ARM SOFT M / 89B\_M

cm 55x50 - h cm 81 - h seat cm 47



SLIM CHAIR WOOD SOFT M / 89E\_M

cm 45x52 - h cm 80 - h seat cm 47



SLIM CHAIR STUDIO 5 SOFT M / 89N\_M

cm ø 72 - seat cm 39x45 -  
h cm 75 ↔ 85 - h seat cm 44 ↔ 54



SLIM CHAIR STUDIO 4 SOFT M / 89Q\_M

cm ø 72 - seat cm 39x45 -  
h cm 72 ↔ 84 - h seat cm 41 ↔ 53



SLIM CHAIR 4 SOFT L / 89C\_L

cm 56x53 - h cm 81 - h seat cm 47



SLIM CHAIR 4 ARM SOFT L / 89D\_L

cm 56x53 - h cm 81 - h seat cm 47



SLIM CHAIR SLEDGE SOFT L / 89A\_L

cm 55x50 - h cm 80 - h seat cm 47

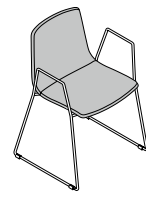

SLIM CHAIR SLEDGE ARM SOFT L / 89B\_L

cm 55x50 - h cm 81 - h seat cm 47



SLIM CHAIR WOOD SOFT L / 89E\_L

cm 45x52 - h cm 80 - h seat cm 47



SLIM CHAIR STUDIO 5 SOFT L / 89P

cm ø 72 - seat cm 39x45 -  
h cm 76 ↔ 86 - h seat cm 44 ↔ 54



SLIM CHAIR STUDIO 4 SOFT L / 89R

cm ø 72 - seat cm 39x45 -  
h cm 73 ↔ 85 - h seat cm 41 ↔ 53

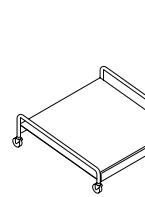

SLIM CHAIR TROLLEY / 89X

cm 64x64 - h cm 21

\* AVAILABLE FOR OUTDOOR

# FINISHES

## STRUTTURA / STRUCTURE / GESTELL / STRUCTURE

Acciaio/Alluminio cromato  
Chromed/Aluminium steel  
Stahl/Aluminium verchromt  
Acier/Aluminium chromé



CR

Alluminio lucidato  
Polished Aluminium  
Aluminium poliert  
Aluminium poli



AB

AB solo per Studio  
AB only for Studio  
AB nur für Studio  
AB uniquement pour Studio

\* Alluminio/acciaio verniciato goffrato  
Textured lacquered aluminium/steel  
Lackiertes gerauhtes Aluminium/Stahl  
Aluminium/acier laqué granité



A019



A011



A047



A022



A051

Verniciatura a poro aperto  
Coloured stains  
Offenporig lackiert  
Laquage à pore ouvert



V131



V140



V142

solo per Wood  
only for Wood  
nur für Wood  
uniquement pour Wood

Legno  
Wood  
Holz  
Bois

Rovere  
Oak  
Eiche  
chêne



RV

Rovere grigio cenere  
Ash grey oak  
Eiche aschgrau  
Chêne gris cendré

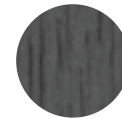

RC

solo per Wood  
only for Wood  
nur für Wood  
uniquement pour Wood

## SCocca / SHELL / SITZSCHALE / COQUE

\* Polipropilene  
Polypropylene  
Polypropylen  
Polypropylène



PP01



PP05



PP03

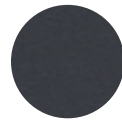

PP04



PP02

## SEDUTA & SCHIENALE - CUSCINO / SEAT & BACK - PAD / SITZ & RÜCKENLEHNE - KISSEN / ASSISE & DOSSIER - COUSSIN

Tessuti  
Fabric  
Stoff  
Tissu

Camira® A  
Xtreme  
Urban

Kvadrat® B  
Maple  
Remix  
Tonus

Kvadrat® C  
Canvas  
Divina  
Foss

Kvadrat® C  
Hallingdal 65  
Hero  
Steelcut  
Steelcut Trio

Ecopelle  
Eco-leather  
Kunstleder  
Simili cuir

Ecopelle  
Serge Ferrari®  
Stamskin Top®

Pelle Pelle Frau® SC ColorSphere®  
Pelle Frau® SC ColorSphere® leather  
Pelle Frau® SC ColorSphere® Leder  
Cuir Pelle Frau® SC ColorSphere®



B004



B020



B026



B056



B057



B080

altri colori disponibili su richiesta  
other colours available on request

Nota piedini in materiale plastico: se la struttura è verniciata nero (A011) anche i piedini sono neri; in tutti gli altri casi sono traslucidi.  
Note for feet in plastic material: if the structure is lacquered in black (A011), feet are black too; in all other combinations they are translucent.



# SPAGHETTI PALUDIS

GIANDOMENICO BELOTTI



Simbolo nella storia del design, *spaghetti chair* è la prima delle sedie Alias entrate nella collezione del MoMA di New York. La struttura è in acciaio verniciato o cromato; le sedute e gli schienali sono prodotti nella caratteristica tessitura in tondino di pvc, discreti nella versione trasparente e più decisi nelle diverse tinte. E ancora, in varianti come la speciale paglia della serie *paludis*, che suggeriscono inaspettate esperienze tattili e visive.

Der Designklassiker *spaghetti chair* ist der erste Stuhl von Alias, der in die Kollektion des MoMA in New York aufgenommen wurde. Seine Struktur besteht aus lackiertem oder verchromtem Stahl, die Sitzflächen und Rückenlehnen aus PVC-Schnur, die um das Gestell gewickelt ist. In der transparenten Version wirken sie diskret, in der farbigen Ausführung entschlossener. Weitere Varianten aus einem speziellen Bastgeflecht bieten der Serie *paludis* unerwartete taktile und visuelle Eindrücke.

A symbol in the history of design, *spaghetti chair* is the first Alias chair to appear in the MoMA collection of New York. The structure is in lacquered or chromed steel, the seats and backs in the distinctive woven PVC, subtle in the transparent version and more striking in the various coloured versions. Also available in variants like the special straw of the *paludis* series that enable unexpected tactile and visual experiences.

Chaise emblématique de l'histoire du design, *spaghetti chair* est le premier des sièges Alias à entrer dans la collection du MoMA de New York. Sa structure est en acier laqué ou chromé et assise et dossier avec le tressage caractéristique en fil PVC, discret dans la version transparente et plus marqué dans ses différentes déclinaisons chromatiques. Disponible en paille spéciale de la série *paludis* qui suggèrent des expériences tactiles et visuelles inattendues.

# SPAGHETTI



---

SPAGHETTI GEMINI



---

SPAGHETTI CHAIR



---

SPAGHETTI ARMCHAIR



---

SPAGHETTI ARMREST



---

SPAGHETTI STOOL



# PALUDIS



PALUDIS CHAIR



PALUDIS STOOL

Nata dall'evoluzione del concept della *spaghetti*, *paludis* accosta la minimale struttura in metallo, verniciata o cromata, al particolare materiale scelto per la tessitura di seduta e schienale: una speciale "paglia" di carta riciclata intrecciata, in un'ampia cartella di colori. La sua duplice personalità, tra memoria e design, la rende una sedia adattissima ad accostarsi a ogni tavolo e arredamento.

The design of the *paludis* chair represents a development of the *spaghetti* concept, and it combines a minimal lacquered or chromed metal structure with the unusual material selected for the woven seat and back: a special "straw" made from recycled paper in a wide variety of colours. Its dual personality, that mixes tradition and design, makes it the ideal chair to accompany any table and interior.

Aus der Weiterentwicklung des *spaghetti* Konzepts kombiniert *paludis* die minimalistische Metallstruktur, in lackierter oder verchromter Ausführung mit einem speziellen Material für die Sitzfläche und Rückenlehne. Diese besteht aus einem besonderen „Korbgeflecht„ aus recyceltem Papier, welches in verschiedenen Farben erhältlich ist. Aufgrund des Zusammenspiels von Tradition und Design lässt sich der Stuhl nahezu mit jedem Tisch und zu jedem Interieur einsetzen.

Issue de l'évolution du concept de la chaise *spaghetti*, la chaise *paludis* marie la structure minimale en métal laqué ou chromé avec le matériau original choisi pour le tissage de l'assise et du dossier: une "paille" spéciale en papier recyclé tressé, disponible dans une vaste palette de coloris. Sa double personnalité, à mi-chemin entre tradition et design, lui permet de trouver facilement sa place à une table ou dans un environnement.



SPAGHETTI  
STEEL (CR) PVC (P000)

## DIMENSIONS



SPAGHETTI CHAIR / 101

cm 40x51 - h cm 84 - h seat cm 47



SPAGHETTI ARMREST / 131

cm 54x51 - h cm 84 - h cm seat 47



SPAGHETTI ARMCHAIR / 109

cm 68x59 - h cm 7 - h cm seat 42

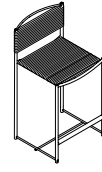

SPAGHETTI STOOL / 164

cm 45x49 - h cm 87 - h cm seat 64

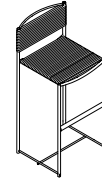

SPAGHETTI STOOL / 180

cm 45x49 - h cm 102 - h cm seat 80



SPAGHETTI GEMINI / 100

cm 42x52 - h cm 83 - h cm seat 47



PALUDIS CHAIR / 150

cm 40x49 cm - h cm 83 - h cm seat 45

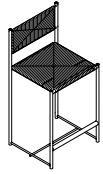

PALUDIS STOOL / 151

cm 45x46 - h cm 92 - h cm seat 64

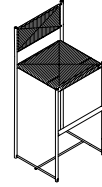

PALUDIS HIGH STOOL / 152

cm 45x46 - h cm 107 - h cm seat 80

## FINISHES

### STRUTTURA / STRUCTURE / GESTELL / STRUCTURE

Acciaio cromato  
Chromed steel  
Stahl verchromt  
Acier chromé



CR

Acciaio verniciato gofrato  
Textured lacquered steel  
Lackiertes gerauhtes Stahl  
Acier laqué granité



A019



A011



A047



A022  
Only for Paludis



A051



A041  
Only for Spaghetti

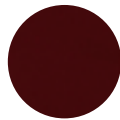

A042

### SEDUTA & SCHIENALE / SEAT & BACK / SITZ & RÜCKENLEHNE / ASSISE & DOSSIER

#### PALUDIS

Paglia  
Paper straw  
Bastgeflecht  
Paille



PG01



PG04



PG05



PG06

#### SPAGHETTI

Tondino in PVC  
PVC  
PVC-Schnur  
Fil PVC



P000



P001



P002



P009



P021



P019



# SEGESTA COLLECTION

ALFREDO HÄBERLI



Le poltroncine *segesta* avvolgono senza essere ingombranti, offrendo un generoso bracciolo che nasce dal disegno dello schienale. Ampie e sinuose curve nella scocca disegnano le sedie *erice* e *selinunte*, ergonomiche e pratiche nell'utilizzo. La scocca è in tecnopolimero. La sua forma e le sue funzioni si prestano a interni o esterni d'immagine.

Die Sessel der Serie *segesta* umschließen den Körper, ohne dabei sperrig zu wirken und haben großzügige Armlehnen, die direkt aus der Rückenlehne entspringen. Die Sitzschale, mit weiten, geschwungenen Kurven charakterisiert das Design der Stühle *erice* und *selinunte*. Sie besteht aus Technopolymer und ist sowohl ergonomisch als auch zweckmäßig. Dank ihrer Form sind die Stühle für den Wohnbereich genauso einsetzbar wie für den Außenbereich.

*Segesta* small armchairs enclose without being cumbersome, with generous armrests which originate directly from the backrest. *Erice* and *selinunte* chairs with their smooth, flowing curves are ergonomic and practical. The shell is made of technopolymer. Its shape and functions are appropriate for prestigious indoor and outdoor environments.

Les fauteuils *segesta* enveloppent sans encombrer et offrent un accoudoir généreux issu du design du dossier. Une coque aux courbes amples et sinueuses dessine les chaises *erice* et *selinunte*, ergonomiques et pratiques à utiliser. La coque est en technopolymère. Sa forme et ses fonctions se prêtent aussi bien aux intérieurs qu'aux extérieurs élégants.

## SEGESTA COLLECTION



SELINUNTE



ERICE



SEGESTA

Materiale plastico della scocca riciclato al 40%.  
Plastic material of the shell 40% recycled.  
Kunststoffmaterial der Schale aus 40% recyceltem Material.  
Matière plastique de la coque recyclée à 40%

Discover all segesta chair on [alias.design](https://alias.design)  
Scopri tutti le sedute segesta su [alias.design](https://alias.design)

# OVERWIEV



**Shell / Scocca**  
Plastic material  
*Materiale plastico*



**Structure / Struttura**  
Aluminium / Alluminio

**chair:** chair with 4-leg structure in lacquered or chromed steel.  
**chair:** sedia con struttura a quattro gambe in acciaio verniciato o cromato.



**sledge:** chair with sledge structure in lacquered or chromed steel.  
**sledge:** sedia con struttura a slitta in acciaio verniciato o cromato.



**studio:** chair with soft or hard castors and 5-star swivel base in lacquered steel.  
**studio:** sedia su ruote morbide o rigide ad altezza regolabile con base girevole a 5 razze con struttura in acciaio verniciato.



**wood:** chair with solid oak wood structure. Structure in oak wood or coloured stains.  
**wood:** sedia con struttura in legno massello di rovere. Struttura in essenze di rovere o verniciata a poro aperto.

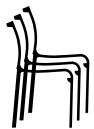

Stackable structure. Available for CHAIR and SLEDGE structure (up to 10 seats).  
Struttura impilabile. Disponibile per CHAIR e SLEDGE (fino a 10 sedie).



The mark of responsible forestry

La collezione di sedute *segesta / erice / selinunte* è caratterizzata da numerose varianti che consentono di rispondere con semplicità a diverse domande funzionali.

Peculiarity of the chair collections *segesta / erice / selinunte* is the variety of versions answering with simplicity to different functional requests.

Die Stuhl-Kollektion *segesta / erice / selinunte* zeichnet sich durch zahlreiche Varianten aus und erfüllt somit einfach eine Vielzahl von diversen Ansprüchen.

La collection d'assises *segesta / erice / selinunte* est caractérisée par nombreuses variantes qui permettent de répondre avec simplicité à différentes demandes fonctionnelles.

# DIMENSIONS



SEGESTA CHAIR / 500 \*

cm 59x56 - h cm 80 - h seat cm 47

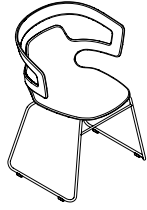

SEGESTA SLEDGE / 501 \*

cm 59x56 - h cm 80 - h seat cm 47



SEGESTA STUDIO / 508

Ø cm 59 - h cm 77 ↔ 87  
h seat cm 44 ↔ 54



SEGESTA WOOD / 558

cm 59x56 - h cm 79 - h seat cm 47



ERICE CHAIR / 50A

cm 54x58 - h cm 78 - h seat cm 46

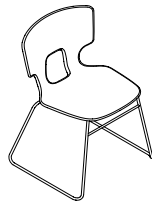

ERICE SLEDGE / 50B

cm 59x53 - h cm 78 - h seat cm 46



ERICE STUDIO / 50C

Ø cm 61 - h cm 76 ↔ 86  
h seat cm 43 ↔ 53



ERICE WOOD / 50E

cm 52x55 - h cm 79 - h seat cm 47



SELINUNTE CHAIR / 530

cm 52x55 - h cm 76 - h seat cm 47



SELINUNTE SLEDGE / 531

cm 56x55 - h cm 76 - h seat cm 47



SELINUNTE STUDIO / 538

Ø cm 61 - h cm 74 ↔ 84  
h seat cm 44 ↔ 54



SELINUNTE WOOD / 561

cm 52x55 - h cm 75 - h seat cm 47



ERICA PAD SOFT / 51Z



SOFT PAD SEGESTA / SELINUNTE / 551

Sedute disponibili nella versione impilabile.  
Chairs available in the stacking version.  
Stühle verfügbar in der stapelbaren Version  
Sièges disponibles dans la version empilable.

\* AVAILABLE FOR OUTDOOR



# FINISHES

## STRUTTURA / STRUCTURE / GESTELL / STRUCTURE

Acciaio cromato  
Chromed steel  
Stahl verchromt  
Acier chromé



CR

IS

Acciaio verniciato goffrato  
Textured lacquered steel  
Lackiertes gerauhtes Stahl  
Acier laqué granité



\*A019

A011

A047

A022

A051

Verniciatura a poro aperto  
Coloured stains  
Offenporig lackiert  
Laquage à pore ouvert



V131

V140

V142

solo per Wood  
only for Wood  
nur für Wood  
uniquement pour Wood

Legno  
Wood  
Holz  
Bois

Rovere  
Oak  
Eiche  
Chêne



RV

Rovere grigio cenere  
Ash grey oak  
Eiche aschgrau  
Chêne gris cendré



RC

solo per Wood  
only for Wood  
nur für Wood  
uniquement pour Wood

## SCOCCA / SHELL / SITZSCHALE / COQUE

\* Materiale plastico  
Plastic material  
Kunststoffmaterial  
Matériau plastique



H112

## CUSCINO / PAD / KISSEN / COUSSIN

Tessuti  
Fabric  
Stoff  
Tissu

Camira® A  
Xtreme  
Urban

Kvadrat® B  
Maple  
Remix  
Tonus

Kvadrat® C  
Canvas  
Divina  
Foss

Hallingdal 65  
Hero  
Steelcut  
Steelcut Trio

Pelle Pelle Frau® SC ColorSphere®  
Pelle Frau® SC ColorSphere® leather  
Pelle Frau® SC ColorSphere® Leder  
Cuir Pelle Frau® SC ColorSphere®

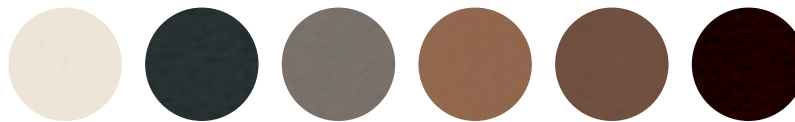

B004

B020

B026

B056

B057

B080

altri colori disponibili su richiesta  
other colours available on request

Feltro  
Felt  
Filz  
Feutre



F001

F003

F004

F005

F006

\* AVAILABLE FOR OUTDOOR  
INOX STEEL (IS) ONLY FOR OUTDOOR



# TAORMINA COLLECTION

ALFREDO HÄBERLI



Sviluppate dal concept di *segesta*, *selinunte* ed *erice*, sono le sedie imbottite *taormina*, *tindari* ed *enna*. Caratteristica è la scocca imbottita, realizzata in tecnopolimero accoppiato a poliuretano espanso flessibile, che dona morbidezza e comfort alle sedute completamente sfoderabili. A supporto della scocca, avvolgente per *taormina*, sobria e discreta per *tindari* ed *enna*, ci sono diverse strutture.

Die Polsterstühle *Taormina*, *Tindari* und *Enna* wurden nach den Konzepten der Modelle *Segesta*, *Selinunte* und *Erice* entwickelt. Ihr charakteristisches Merkmal sind die gepolsterten Sitzflächen aus Technopolymer in Verbindung mit einem flexiblen Polyurethanschaum, die diesen Stühlen einen besonderen Komfort verleihen. Die Bezüge sind komplett abziehbar. Zur Unterstützung der Schale, umhüllend bei dem Modell *Taormina* bzw. schlicht und diskret bei *Tindari* und *Enna*, gibt es verschiedene Gestellformen.

The padded chairs *taormina*, *tindari* and *enna* have been developed from the concept of *segesta*, *selinunte* and *erice*. A salient trait of this collection is the padded shell made of technopolymer mated to flexible polyurethane foam, which gives softness and comfort to the seats featuring fully removable covers. The wrap-around shells for *taormina*, refined and discreet for *tindari* and *enna* - are supported by different structures.

Développées à partir du concept de *segesta*, *selinunte* et *erice*, voici les chaises rembourrées *taormina*, *tindari* et *enna*. Elles se distinguent par leur coque rembourrée, réalisée en technopolymère couplé à du polyuréthane expansé flexible, qui apporte douceur et confort à ces chaises entièrement déhoussables. La coque, enveloppante pour *taormina*, sobre et discrète pour *tindari* et *enna*, est supportée par différentes structures.

## TAORMINA COLLECTION



TAORMINA



ENNA



TINDARI

Discover all taormina chairs on [alias.design](https://alias.design)  
Scopri tutte le sedute taormina su [alias.design](https://alias.design)

## OVERWIEV



TINDARI



ENNA



TAORMINA



\*

**chair:** armchair with 4-leg structure in lacquered or chromed steel.

**chair:** poltroncina con struttura a quattro gambe in acciaio verniciato o cromato.

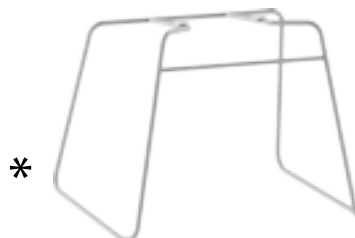

\*

**sledge:** armchair with sledge structure in lacquered or chromed steel.

**sledge:** poltroncina con struttura a slitta in acciaio verniciato o cromato.



**studio:** armchair with soft or hard castors and 5-star swivel base in lacquered steel.

**studio:** poltroncina su ruote morbide o rigide ad altezza regolabile con base girevole a 5 razze con struttura in acciaio verniciato.



**wood:** armchair with solid oak wood structure. Structure in oak or coloured stains.

**wood:** poltroncina con struttura in legno massello di rovere. Struttura in essenze di rovere o verniciata a poro aperto.



\* On request the structure is available in stacking version.  
**Su richiesta la struttura è disponibile nella versione impilabile.**  
 Available only for structure 4 legs and sledge (up to 5 seats).  
 Disponibile solo per struttura 4 gambe e slitta (fino a 5 sedie).



The mark of responsible forestry

## DIMENSIONS



TAORMINA CHAIR / 503

cm 59x56 - h cm 81 - h seat cm 50



TAORMINA SLEDGE / 504

cm 59x56 - h cm 81 - h seat cm 50



TAORMINA STUDIO / 514

Ø cm 59 - h cm 78 ↔ 88  
h seat cm 45 ↔ 55



TAORMINA WOOD / 565

cm 59x56 - h cm 80 - h seat cm 50



ENNA CHAIR / 52A

cm 58x54 - h cm 79 - h seat cm 49

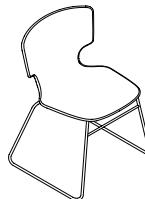

ENNA SLEDGE / 52B

cm 59x53 - h cm 79 - h seat cm 49



ENNA STUDIO / 52C

Ø cm 59 - h cm 77 ↔ 87  
h seat cm 44 ↔ 54



ENNA WOOD / 52E

cm 52x55 - h cm 80 - h seat cm 50



TINDARI CHAIR / 516

cm 52x55 - h cm 77 - h seat cm 50

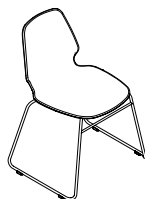

TINDARI SLEDGE / 517

cm 56x55 - h cm 77 - h seat cm 50



TINDARI STUDIO / 519

Ø cm 61 - h cm 75 ↔ 85  
h seat cm 45 ↔ 55



TINDARI WOOD / 571

cm 52x55 - h cm 77 - h seat cm 50

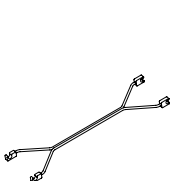

LINK / 521

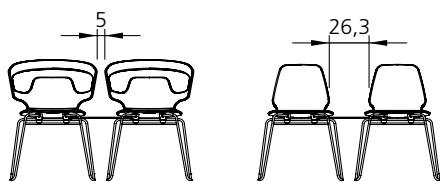

La collezione di sedute *taormina / enna / tindari* è caratterizzata da numerose varianti. Sedie impilabili, poltroncine confortevoli, sedia su ruote, ad altezza regolabile con base girevole, raffinate con la struttura in legno o in acciaio, sono le tipologie che, per forma e funzioni, si prestano a interni d'immagine, per la casa o il contract.

The chair collection *taormina / enna / tindari* selinunte is characterized by a wide number of variants. Stacking chairs, comfortable armchairs, chairs on wheels with adjustable height and swivel base, refined versions with wooden or steel structure: the shape and the function of this models make them suitable for indoor use, both for residential or contract situations.

Die Stuhl-Kollektion *taormina / enna / tindari* zeichnet sich durch zahlreiche Varianten. Stapelbare Stühle, bequeme Sessel, Stühle mit höhenverstellbaren und drehbaren Gestellen auf Rollen, raffinierte Versionen mit Struktur aus Holz oder Stahl: Die Form und die Funktion dieser Modelle machen sie für den Gebrauch in Innenräumen geeignet, sowohl zu Hause als auch im Objektbereich.

La collection de sièges *taormina / enna / tindari* est caractérisée par nombreuses variantes. Chaises empilables, petit fauteuils confortables, chaise sur roulettes à hauteur réglable avec base tournante, raffinées avec la structure en bois ou en acier, sont les variantes qui, pour forme et fonctions, se prêtent à des intérieurs d'image, pour la maison ou dans les collectivités.

# FINISHES

## STRUTTURA / STRUCTURE / GESTELL / STRUCTURE

Acciaio cromato  
Chromed steel  
Stahl verchromt  
Acier chromé



CR

Acciaio verniciato gofrato  
Textured lacquered steel  
Lackiertes gerauhtes Stahl  
Acier laqué granité



A019



A011



A047



A022



A051

Verniciatura a poro aperto  
Coloured stains  
Offenporig lackiert  
Laquage à pore ouvert



V131



V140



V142

solo per Wood  
only for Wood  
nur für Wood  
uniquement pour Wood

Legno  
Wood  
Holz  
Bois

Rovere  
Oak  
Eiche  
Chêne



RV

Rovere grigio cenere  
Ash grey oak  
Eiche aschgrau  
Chêne gris cendré



RC

solo per Wood  
only for Wood  
nur für Wood  
uniquement pour Wood

## SEDUTA & SCHIENALE / SEAT & BACK / SITZ & RÜCKENLEHNE / ASSISE & DOSSIER

Tessuti  
Fabric  
Stoff  
Tissu

**Alias® A**  
Living I  
Living II

**Kvadrat® B**  
Maple  
Tonus

**Kvadrat® C**  
Canvas  
Divina  
Foss  
Hallingdal 65  
Hero  
Steelcut  
Steelcut Trio

**Camira® A**  
Xtreme  
Urban

Ecopelle  
Eco-leather  
Kunstleder  
Simili cuir

**Serge Ferrari®**  
Stamskin® Top

Pelle Pelle Frau® SC ColorSphere®  
Pelle Frau® SC ColorSphere® leather  
Pelle Frau® SC ColorSphere® Leder  
Cuir Pelle Frau® SC ColorSphere®



B004



B020



B026



B056



B057



B080

altri colori disponibili su richiesta  
other colours available on request





# TWIG

NENDO



Combinando magistralmente materiali e tecniche produttive differenti, Nendo firma per Alias il progetto di sedute *twig*. Il concept è una seduta con le gambe inclinate in modo piacevole e dinamico.

Durch die gekonnte Kombination von unterschiedlichen Materialien und Herstellungstechniken, entwirft Nendo für Alias das Stuhlprojekt *twig*. Das Konzept ist ein Sitz mit angenehm und dynamisch schräggestellten Beinen.

With its masterful combination of different materials and production techniques Nendo has put his signature to the *twig* chair project for Alias. The concept is a seat with an aluminium base of generous proportions and legs that slant at a pleasing and dynamic angle.

Alliant de manière magistrale des matériaux et des techniques de fabrication différents Nendo signe pour Alias la chaise *twig*. Le concept repose sur une chaise avec des pieds inclinés de manière agréable et dynamique.

# TWIG



TWIG 4



TWIG COMFORT



TWIG COMFORT SOFT



REDDOT DESIGN AWARD WINNER  
TWIG 4

# DIMENSIONS



TWIG 4 / 10C

cm 52x51 - h cm 70 - h seat cm 44,5



TWIG COMFORT / 10E

cm 52x53 - h cm 77 - h seat cm 48



TWIG COMFORT SOFT / 10E

cm 52x53 - h cm 77 - h seat cm 48

# FINISHES

## TWIG COMFORT

### STRUTTURA / STRUCTURE / GESTELL / STRUCTURE

Acciaio verniciato gofrato  
Textured lacquered steel  
Lackiertes gerauhtes Stahl  
Acier laqué granité

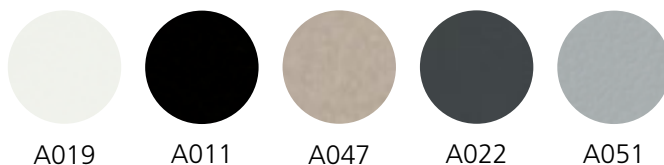

### SEDUTA & SCHIENALE / SEAT & BACK / SITZ & RÜCKENLEHNE / ASSISE & DOSSIER

Materiale plastico  
Plastic material  
Kunststoffmaterial  
Matériau plastique



### CUSCINO / PAD / KISSEN / COUSSIN

Tessuti  
Fabric  
Stoff  
Tissu

**Camira® A**  
Xtreme  
Urban

**Kvadrat® B**  
Maple  
Tonus

**Kvadrat® C**  
Harald  
Hero  
Steelcut  
Steelcut Trio  
Twill Weave

Hallingdal 65  
Harald  
Hero  
Steelcut  
Steelcut Trio  
Twill Weave

Pelle Pelle Frau® SC ColorSphere®  
Pelle Frau® SC ColorSphere® leather  
Pelle Frau® SC ColorSphere® Leder  
Cuir Pelle Frau® SC ColorSphere®



altri colori disponibili su richiesta  
other colours available on request

## TWIG 4

### STRUTTURA / STRUCTURE / GESTELL / STRUCTURE

Acciaio verniciato gofrato  
Textured lacquered steel  
Stahl lackiert gerauht  
Acier laqué granité

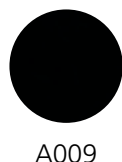

### SEDUTA / SEAT / SITZ / ASSISE

Verniciatura a poro aperto  
Coloured stains  
Offenporig lackiert  
Laquage à pore ouvert





# TABLES & LOW TABLES

TAVOLI & TAVOLI BASSI • TISCHE & NIEDRIGE TISCHE • TABLES & TABLES BASSES

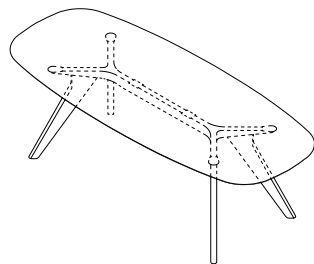

AGO  
pag. 116

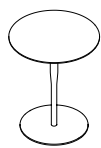

ATLAS  
pag. 12

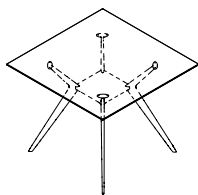

BIPLANE  
pag. 120

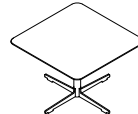

CROSS TABLE  
pag. 128

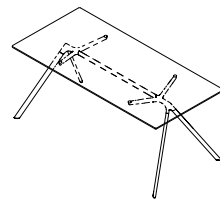
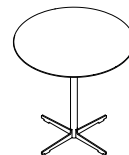

DRY  
pag. 132

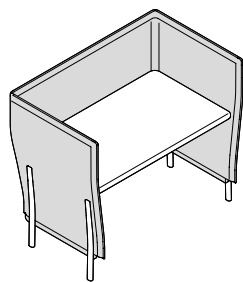

ELEVEN HIGH DESK  
pag. 136

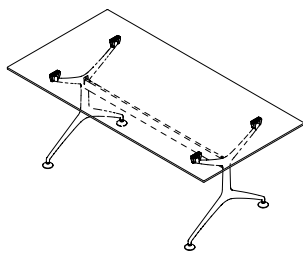

FRAMETABLE  
pag. 140

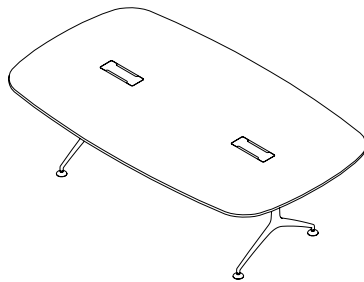

FRAMETABLE MEETING  
pag. 150

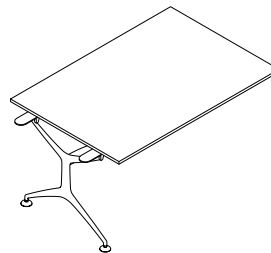

FRAMETABLE SYSTEM  
pag. 156

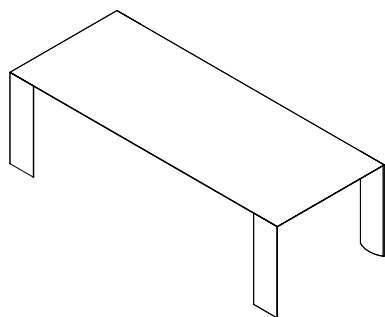
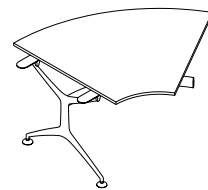

HIWOOD  
pag. 162

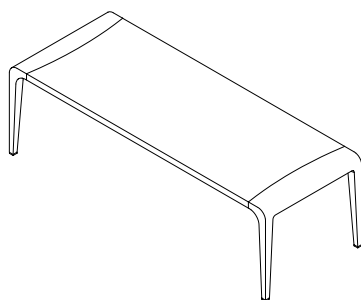

ILVOLO  
pag. 166

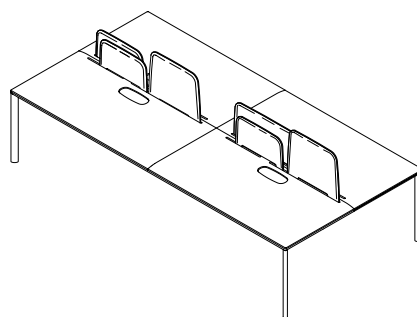

LANDSCAPE  
pag. 170

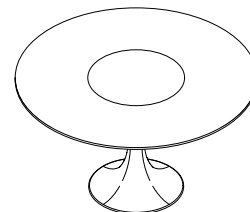

MANZÙ TABLE  
pag. 178

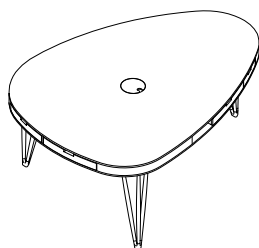

PLETTRO  
pag. 182

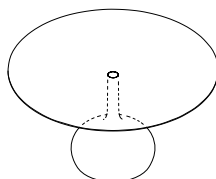
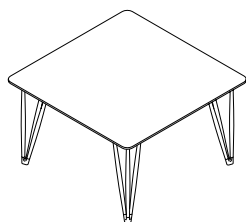

SAEN  
pag. 188

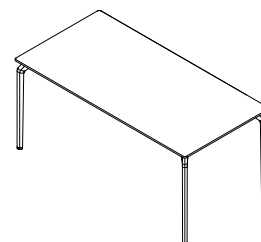
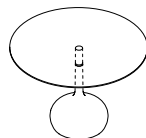

TEC / TEC SYSTEM  
pag. 192



TREE TABLE  
pag. 62



# AGO

ALFREDO HÄBERLI



Assemblando con equilibrio legno e metallo, Alfredo Häberli firma *ago*, un tavolo dal forte segno grafico che reinterpreta in chiave contemporanea i temi classici del design scandinavo. *Ago* è un progetto ricco di dettagli che rivela nella sua semplicità stilistica una grande complessità progettuale. Come nella tradizione Alias, questo tavolo è il risultato di un innovativo approccio tecnologico e di un'estrema cura della bellezza del disegno.

Durch die ausgewogene Kombination von Holz und Metall erschafft Alfredo Häberli den stark grafisch geprägten Tisch *ago*, der eine zeitgenössische Neuinterpretation der klassischen Themen des skandinavischen Designs darstellt. *Ago* ist ein sehr detailreiches Projekt, das in seiner stilistischen Einfachheit eine große projektspezifische Komplexität offenbart. Wie in der Tradition von Alias, ist dieser Tisch das Ergebnis eines innovativen technologischen Ansatzes und eines extremen Augenmerks auf die Schönheit des Designs.

Assembling wood and metal in a balanced way, Alfredo Häberli obtains *ago*, a table with a marked graphic identity, embodying a contemporary interpretation of the classical themes of Scandinavian design. *Ago* is a project rich with details, revealing great design complexity in its stylistic simplicity. Keeping up Alias tradition, this table is the result of a highly innovative technological approach and undivided commitment to the beauty of design.

En assemblant avec équilibre le bois et le métal, Alfredo Häberli dessine *ago*, table au signe graphique marqué, qui revisite les thèmes classiques du design scandinave, en les réactualisant. *Ago* est un projet riche de détails qui, derrière sa simplicité esthétique, cache une grande complexité conceptuelle. Dans la meilleure tradition d'Alias, cette table est le résultat d'une approche technologique innovante et d'un soin extrême apporté à la beauté des lignes.

# AGO



AGO OVAL



AGO RECTANGULAR

Protagonista del tavolo è il piano, dalle forme morbide e accoglienti e la struttura tecnica nascosta sotto di esso, che, oltre a definire l'architettura del progetto, consente una notevole flessibilità all'oggetto. Le gambe, ridisegnate con una forma più morbida che permette di sfruttare al meglio lo spazio di seduta, sono realizzate in legno massello e si agganciano a un telaio in acciaio verniciato.

The protagonist of the table is the top, with its soft and cosy shapes, and the technical structure hidden underneath it, which, besides defining the architecture of the object, endows it with a high degree of flexibility. Designed in a form that is softer and more pliable, the legs – made of solid wood and anchored to a lacquered steel frame – provide extra space in the seat.

Absolute Hauptdarsteller des Tisches sind die Platten mit weichen und gemütlichen Formen und die unter der Platte verborgenen technische Struktur, die nicht nur die Ästhetik des Objekts definiert, sondern dem Objekt eine große Flexibilität auch verleiht. Die weicher umgestalteten Beine aus Massivholz bieten die bestmögliche Ausnutzung der Sitzplätze und werden mit einem Rahmen aus lackiertem Stahl verbunden.

Le protagoniste de la table est le plateau aux formes douces et accueillantes et la structure technique cachée en dessous qui permet une remarquable flexibilité à l'objet. Les pieds, redessinés à partir de formes plus souples pour exploiter plus efficacement l'espace d'assise, sont réalisés en bois massif et se fixent à un cadre en acier laqué.



# DIMENSIONS

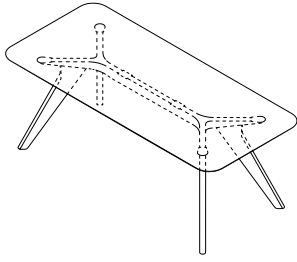

AGO AG5 / AG6

cm 200x90 - h cm 74  
cm 240x100 - h cm 74

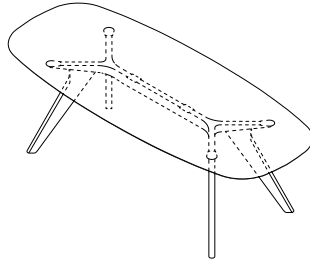

AGO OVAL AG7 / AG8 / AG9

cm 200x90 - h cm 74  
cm 240x100 - h cm 74  
cm 295x100 - h cm 74

# FINISHES

Legno  
Wood  
Holz  
Bois

Rovere naturale  
Natural oak  
Eiche natürliche  
Chêne naturel



RV

Rovere sbiancato  
Whitened oak  
Eiche gebleicht  
Chêne blanchi



RVS

Rovere grigio cenere  
Ash grey oak  
Eiche aschgrau  
Chêne gris cendré



RC

Rovere scuro  
Dark oak  
Eiche dunkel  
Chêne foncé



RVT

Rovere noce canaletto  
Canaletto walnut oak  
Eiche canaletto nußbaum  
Chêne noyer canaletto



NCT

Verniciatura a poro aperto  
Coloured stains  
Offenporig lackiert  
Laquage à pore ouvert



V140

NOTA TELAIO. Il colore del telaio è abbinato alla scelta del piano:  
- con piano rovere naturale, sbiancato o noce canaletto il telaio è sabbia (A047)  
- con piano rovere scuro o grigio cenere il telaio è grigio grafite (A022)  
- con piano nero il telaio è nero (A011).

NOTE FRAME: the frame colour matches the top:  
-with natural, whitened or canaletto walnut oak top, the frame is sand (A047)  
-with dark or ash grey oak top, the frame is graphite grey (A022)  
-with black top, the frame is black (A011).

ANMERKUNG ZU DEN TRAGRAHMEN: die Farbe ist nach der Platteausführung abgestimmt:  
- Mit Platte aus Eiche natur, gebleicht oder Canaletto Nussbaum ist der Rahmen Sand (A047)  
- Mit Platte aus Eiche dunkel oder aschgrauarbit ist der Rahmen grafitgrau (A022)  
- mit schwarzer Platte ist der Rahmen schwarz (A011).

NOTE CHÂSSIS: la couleur du châssis est combinée au plateau:  
-avec plateau chêne naturel, blanchi ou noyer canaletto, le châssis est sable (A047)  
-avec plateau chêne foncé ou gris cendré, le châssis est gris grafite (A022)  
-avec plateau noir, le châssis est noir (A011).



# BIPLANE

ALBERTO MEDA



Un'intuizione compositiva che dà vita ad un sistema di tavoli di grande duttilità nelle forme, nelle dimensioni e negli utilizzi. Il progetto *biplane* nasce dall'idea di ottenere una serie ampia e differenziata di modelli. Le gambe in alluminio pressofuso sono fissate ad un sottopiano centrale e al piano del tavolo, componendo così una solida struttura. Il numero delle gambe è variabile a seconda della dimensione del piano, disponibile in diverse forme e finiture.

Eine kompositorische Intuition. Ein Tischsystem mit vielfältigen Formen, Größen und Verwendungsmöglichkeiten. Das Projekt *biplane* entstand aus der Idee eine breitgefächerte und differenzierte Serie von Modellen anzubieten. Die Beine aus Aluminiumdruckguß sind an einer zentralen Unterplatte und an der Tischplatte befestigt, wodurch eine solide Struktur entsteht. Die Anzahl der Tischbeine ist variabel je nach Größe der Tischfläche, welche verschiedene Formen und Ausführungen annehmen kann.

A strong grasp of form and composition has given life to a collection of tables characterised by great flexibility in terms of shape, size and range of uses. The project *biplane* derives from the idea of creating a broad and differentiated range of designs. The legs in die-cast aluminium are fixed both to a central undertop and to the table top forming a solid structure. The number of legs may vary as a function of the dimensions of the top, available in different shapes and finishes.

Une intuition de composition qui donne vie à un système de tables d'une grande flexibilité dans leurs formes, leurs dimensions et leur utilisation. Ce projet *biplane* a germé de l'idée d'obtenir une série vaste et différenciée de modèles. Le piétement, en aluminium moulé sous pression, est fixé à un sous-plateau central ainsi qu'au plateau de la table pour former une structure solide. Le nombre des pieds varie selon la dimension du plateau, disponible en nombreuses formes et finitions.

# BIPLANE



BIPLANE Ø90



BIPLANE 90x90



BIPLANE Ø120



BIPLANE 200x105



BIPLANE OVAL 210x125



Discover all Biplane tables on [alias.design](https://alias.design)  
Scopri tutti i tavoli Biplane su [alias.design](https://alias.design)

## BIPLANE HIGH



BIPLANE HIGH 200x105



BIPLANE HIGH 120x120

## BIPLANE XS



BIPLANE XS Ø62



BIPLANE XS 150

# DIMENSIONS

## BIPLANE / BIPLANE HIGH

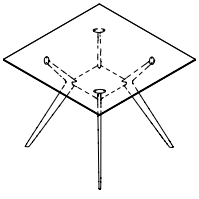

**BIPLANE 90x90 / 400 \***

cm 90x90 - h cm 72

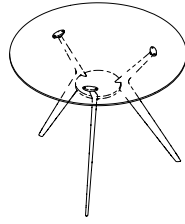

**BIPLANE 401 Ø90 \***

Ø cm 90 - h cm 72

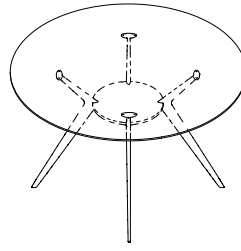

**BIPLANE 402 / Ø120 \***

Ø cm 120 - h cm 72

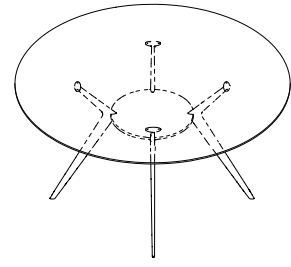

**BIPLANE Ø140 / 403**

Ø cm 140 - h cm 72

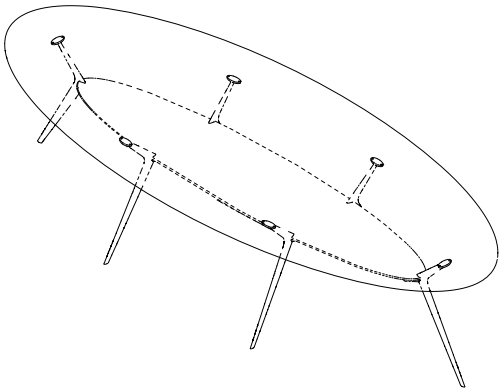

**BIPLANE OVAL 330x130 / 406**

cm 330x130 - h cm 72

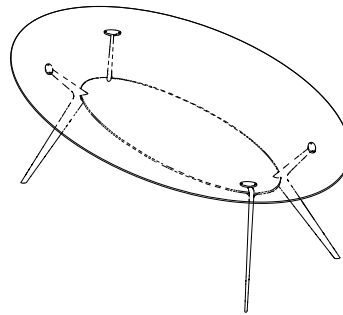

**BIPLANE OVAL 210x125 / 407**

cm 210x125 - h cm 72

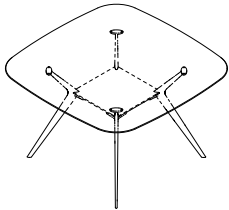

**BIPLANE 120x120 / 40B**

cm 120x120 - h cm 72

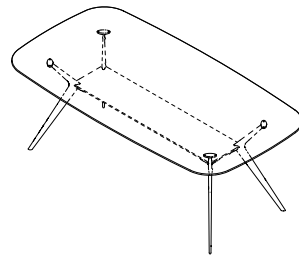

**BIPLANE 200x105 / 40D**

cm 200x105 - h cm 72

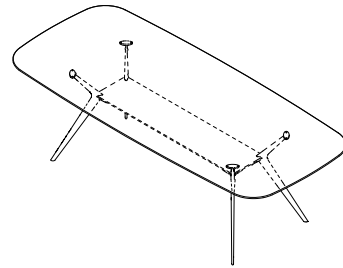

**BIPLANE 240x150 / 40E**

cm 240x105 - h cm 72

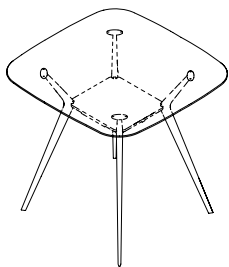

**BIPLANE HIGH 120x120 / 454**

cm 120x120 - h cm 105

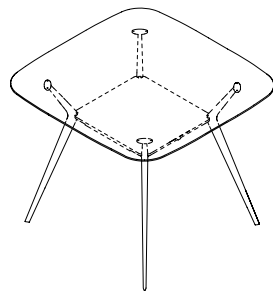

**BIPLANE HIGH 140x140 / 465**

cm 140x140 - h cm 105

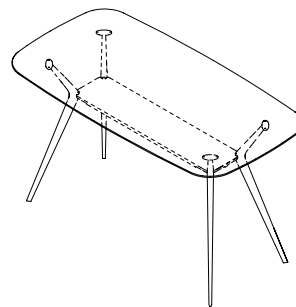

**BIPLANE HIGH 200x105 / 487**

cm 200x105 - h cm 105

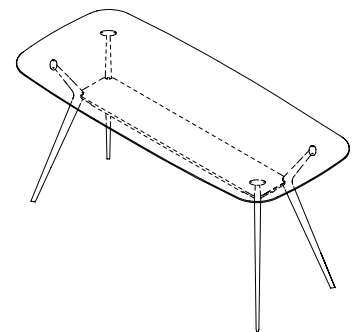

**BIPLANE HIGH 240x105 / 491**

cm 240x105 - h cm 105

# DIMENSIONS

## BIPLANE XS

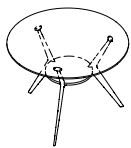

BIPLANE XS Ø62 / 404 \*

Ø cm 62 - h cm 46

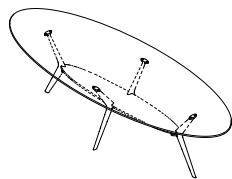

BIPLANE XS 150 / 411

cm 150x55 - h cm 39



BIPLANE XS 60x60 OUTDOOR / B02\_O

cm 60x60 - h cm 46



BIPLANE XS TRIANGULAR OUTDOOR / B01\_O

cm 62x57 - h cm 46

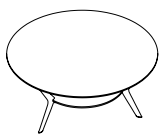

BIPLANE XS Ø80 OUTDOOR / B03\_O

cm Ø80 - h cm 35

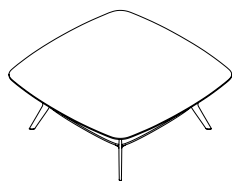

BIPLANE XS 95x95 OUTDOOR / B04\_O

cm 95x95 - h cm 35

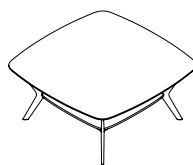

BIPLANE XS 80x80 OUTDOOR / B05\_O

cm 80x80 - h cm 35

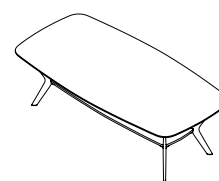

BIPLANE XS 120x60 OUTDOOR / B06\_O

cm 120x60 - h cm 35

\* AVAILABLE FOR OUTDOOR  
ONLY FOR OUTDOOR USE

## INTERIOR SOLUTIONS



**BIPLANE**  
FINISHES: TEXTURED LACQUERED ALUMINIUM (A009) LACQUERED MDF (V130)  
**MEETINGFRAME+ TILT 47**  
FINISHES: TEXTURED LACQUERED ALUMINIUM (A019) FABRIC KVADRAT®



**BIPLANE HIGH**  
FINISHES: TEXTURED LACQUERED ALUMINIUM (A011) LACQUERED MDF (V130)  
**KOBI STOOL**  
FINISHES: TEXTURED LACQUERED ALUMINIUM/STEEL (A009) FABRIC KVADRAT®



# FINISHES

## STRUTTURA / STRUCTURE / GESTELL / STRUCTURE

Alluminio lucidato  
Polished Aluminium  
Aluminium poliert  
Aluminium poli



AB

Non disponibile per Biplane High  
Not available for Biplane High  
Nicht verfügbar für Biplane High  
Pas disponible pour Biplane High

Alluminio/acciaio verniciato gofrato  
Textured lacquered aluminium/steel  
Lackiertes gerauhtes Aluminium/Stahl  
Aluminium/acier laqué granité



\* A019

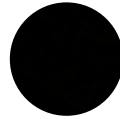

A011



A047



A022



A051

## PIANO / TOP / TISCHPLATTE / PLATEAU

MDF laccato  
Lacquered MDF  
MDF lackiert  
MDF laqué



V001

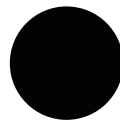

V130



V007

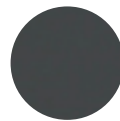

V003



V110

Bilaminato  
Bilaminate  
Bilaminat  
Bilaminé



BBCO



BNER

Non disponibile per Biplane High  
Not Available for Biplane High  
Nicht verfügbar für Biplane High  
Pas disponible pour Biplane High

Marmo bianco di Carrara  
Marble bianco Carrara  
Marmor bianco Carrara  
Marbre bianco Carrara



MA01

Non disponibile per Biplane High  
Not available for Biplane High  
Nicht verfügbar für Biplane High  
Pas disponible pour Biplane High

Impiallacciato  
Veneered  
Furnierung  
Plaqué

Rovere naturale  
Natural oak  
Eiche natürliche  
Chêne naturel

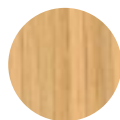

RV

Solo su formati tondo e quadrato  
Only on round and square tops  
Nur bei runden und quadratischen Platten  
Uniquement sur le format rond et carré

Pietra acrilica  
Acrylic stone  
Acrylstein  
Pierre acrylique



PR01

Solo per Biplane outdoor  
Only for Biplane outdoor  
Nur für Biplane outdoor  
Uniquement pour Biplane outdoor



# CROSS TABLE

ALFREDO HÄBERLI



Un'ampia collezione di tavoli e tavolini, con piani in full color disponibili in diverse forme e dimensioni, che poggiano sulla struttura cross: una base a croce, in acciaio verniciato, disponibile in diversi colori. Raffinati e d'impatto i *cross tables* arredano in modo riconoscibile e funzionale sia gli ambienti di casa che le situazioni contract.

Eine breite Kollektion von Tischen und niedrigen Tischen, verfügbar mit Platten aus Full Color in verschiedenen Formen und Größen, die auf das *cross* Gestell aufliegen: ein kreuzförmiges Gestell aus lackiertem Stahl erhältlich in verschiedenen Farben. Die raffinierten und als Blickfang dienenden *cross table* eignen sich sowohl für die funktionelle Einrichtung von Wohn- als auch von Kontraktbereichen.

A wide collection of small tables, with a top in full color available in different shapes and sizes placed on the cross structure: a cross base in lacquered steel available in different colours. Refined and eye-catching, the *cross tables* furnishes in a distinctive and functional manner, both home environment and contract settings.

Une ample collection de tables et petites tables avec plateaux en full color disponibles en différentes formes et dimensions qui posent sur la structure cross: une base à croix en acier laqué, disponible en différentes couleurs. Rafinées et de fort impact, les *cross tables* meublent d'une façon reconnaissable et fonctionnelle soit les maisons soit les situations contract.

# CROSS



CROSS TABLE



CROSS LOW TABLE

# INTERIOR SOLUTION



**CROSS**  
FINISHES: TEXTURED LACQUERED STEEL (A019) FULL COLOR (FC01)  
**TAORMINA LARGE SLEDGE**  
FINISHES: TEXTURED LACQUERED STEEL (A019) FABRIC KVADRAT®

## DIMENSIONS

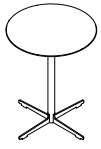

CROSS TABLE Ø60 / 572\_75 \*

Ø cm 60 - h cm 75



CROSS TABLE Ø80 / 573\_75 \*

Ø cm 80 - h cm 75

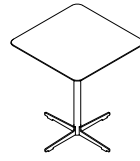

CROSS TABLE 65x65 / 574\_75 \*

cm 65x65 - h cm 75

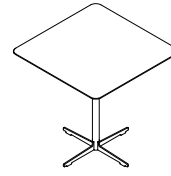

CROSS TABLE 80x80 / 577\_75 \*

cm 80x80 - h cm 75



CROSS LOW TABLE Ø60 / 572\_45 \*

Ø cm 60 - h cm 45



CROSS LOW TABLE Ø80 / 573\_45 \*

Ø cm 80 - h cm 45



CROSS LOW TABLE 65x65 / 574\_45 \*

cm 65x65 - h cm 45

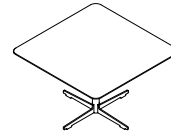

CROSS LOW TABLE 80x80 / 577\_45 \*

cm 80x80 - h cm 45

## FINISHES

### STRUTTURA / STRUCTURE / GESTELL / STRUCTURE

Acciaio verniciato goffrato  
Textured lacquered steel  
Lackiertes gerauhtes Stahl  
Acier laqué granité



\* A019

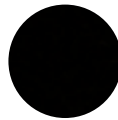

A011



A047



A022



A051

### PIANO / TOP / TISCHPLATTE / PLATEAU

Full color  
Full color  
Full color  
Full color



FC01



FC02

Pietra acrilica  
Acrylic stone  
Acrylstein  
Pierre acrylique



PR01

Solo per Cross outdoor  
Only for Cross outdoor  
Nur für Cross outdoor  
Uniquement pour Cross outdoor

\* AVAILABLE FOR OUTDOOR



# DRY

ALBERTO MEDA



Era il 1987 quando Alberto Meda sperimentava il poliuretano compatto costampato con il metallo sul tavolo *dry*. Oggi questo progetto torna protagonista delle collezioni Alias per raccontare la capacità dell'azienda di far incontrare leggerezza stilistica e tecnologia d'avanguardia. Rivisitato nella geometria delle gambe e nell'attacco tra struttura e piano, *dry* è la sintesi perfetta di un pensiero progettuale che riscopre nell'essenzialità formale una straordinaria ricchezza compositiva.

Im Jahr 1987 experimentierte Alberto Meda kompaktem Polyurethan gegossen mit Metall auf dem *dry* Tisch. Heute kehrt dieses Projekt als Protagonist von Alias-Kollektionen zurück und erzählt die Fähigkeit des Unternehmens, stilistische Leichtigkeit und Spitzentechnologie miteinander zu verbinden. In der Geometrie der Beine und in der Verbindung zwischen Struktur und Platte neu interpretiert, ist *dry* die perfekte Synthese eines Designgedankens, der in der formalen Wesentlichkeit einen außergewöhnlichen kompositorischen Reichtum wiederentdeckt.

In 1987 Alberto Meda experimented compact polyurethane moulded with metal on the *dry* table. Today this project returns as the protagonist of Alias collections to tell the company's ability to bring together stylistic lightness and cutting-edge technology. The geometry of the legs and the connection between structure and top has been revisited and *dry* is now the perfect synthesis of a design thought that rediscovers an extraordinary compositional richness in formal essentiality.

C'était en 1987 qu'Alberto Meda expérimentait le polyuréthane compact moulé avec le métal sur la table *dry*. Aujourd'hui, ce projet revient en tête des collections Alias pour raconter la capacité de l'entreprise à allier légèreté stylistique et technologie d'avant-garde. Revisité dans la géométrie des pieds et dans la connexion entre la structure et le plateau, *dry* est la synthèse parfaite d'une pensée conceptuelle qui redécouvre dans l'essentialité formelle une extraordinaire richesse de composition.

DRY



DRY



DRY LOW TABLE

## INTERIOR SOLUTIONS



**DRY**  
FINISHES: TEXTURED LACQUERED ALUMINIUM (A019) GLASS (VTT)  
**E LA NAVE VA**  
FINISHES: TEXTURED LACQUERED ALUMINIUM (A019) FABRIC ALIAS LIVING®  
**SLIM LOUNGE LOW**  
FINISHES: TEXTURED LACQUERED ALUMINIUM (A011) FABRIC KVADRAT®



## DIMENSIONS

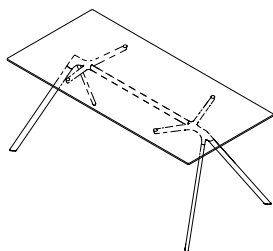

DRY / 45A

cm 160/180x90 - h cm 72

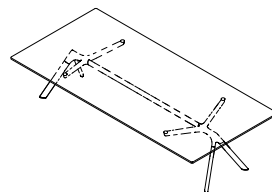

DRY LOW TABLE / 45B

cm 120/150/170x80 - h cm 38

L'elegante base in alluminio si snoda in una forma seducente grazie a un giunto che diventa il dettaglio chiave dell'intero progetto. Il piano in cristallo risolve in un solo elemento la funzionalità dell'oggetto e la sua componente estetica, lasciando intravedere la bellezza della struttura.

The elegant aluminium base is articulated into a seductive shape thanks to a joint that becomes the key detail of the entire project. The glass top combines the functionality of the object and its aesthetic component in a single element, revealing the beauty of the structure.

Dank einer Verbindung, die zum Schlüsseldetail des gesamten Projekts wird, zieht sich das elegante Aluminiumgestell zu einer verführerischen Form dahin. Die Glasplatte löst die Funktionalität des Objekts und seine ästhetische Komponente in einem einzigen Element auf und enthüllt die Schönheit der Struktur.

L'élégant piètement en aluminium s'articule dans une forme séduisante grâce à un joint qui devient le détail clé de l'ensemble du projet. Le plateau en verre résout la fonctionnalité de l'objet et sa composante esthétique en un seul élément, révélant la beauté de la structure.

## FINISHES

### STRUTTURA / STRUCTURE / GESTELL / STRUCTURE

Alluminio verniciato goffrato  
Textured lacquered aluminium  
Lackiertes gerauhtes Aluminium  
Aluminium laqué granité

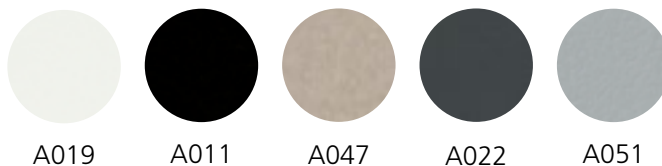

Alluminio verniciato metallizzato  
Metallic lacquered aluminium  
Aluminium Metallic lackiert  
Aluminium laqué métallise

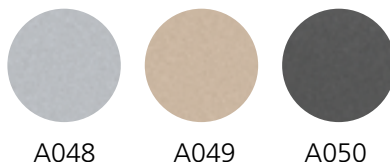

### PIANO / TOP / TISCHPLATTE / PLATEAU

Vetro  
Glass  
Glas  
Verre

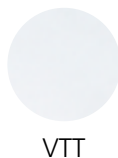

VTT



# ELEVEN HIGH DESK

PEARSONLLOYD



*Eleven high desk* è un innovativo sistema di scrivanie che risponde, con un approccio estetico e funzionale, alle esigenze degli ambienti di lavoro più dinamici. Oltre a rappresentare il naturale completamento della famiglia di sedute firmata da PearsonLloyd, queste versioni arricchiscono la proposta Alias dedicata al contract, inteso come nuovo ambito di applicazione dell'office, e pone le necessità dell'uomo al centro del progetto.

*Eleven high desk* ist ein innovatives Schreibtischsystem, das auf ästhetische und funktionale Weise die Anforderungen dynamischer Arbeitsumgebungen zufrieden stellt. Diese Versionen sind nicht nur eine natürliche Vervollständigung der von PearsonLloyd geschaffenen Stuhlfamilie, sondern bereichern sie das Angebot von Alias für den Contract Bereich als neuen Anwendungsbereich des Büros und stellen die Bedürfnisse der Person im Mittelpunkt des Projekts.

*Eleven high desk* is a ground-breaking desk system that meets the requirements of the most dynamic working environments through an approach that combines aesthetic and functional considerations. Besides providing a natural extension of the range of seats designed by PearsonLloyd, these versions enrich Alias proposal for the contract sector, which is viewed as a new field of application for office furniture and place the needs of the individual at the centre of the design project.

*Eleven high desk* est un innovant système de bureaux qui répond aux exigences des espaces de travail les plus dynamiques avec un approche esthétique et fonctionnelle. Ces versions ne se limitent pas à constituer le complètement naturel de la famille d'assises signée PearsonLloyd, mais elles enrichissent aussi la solution Alias consacrée au contract entendu comme le nouveau secteur d'application de l'office, et elle met les nécessités de l'homme au centre du projet.

# ELEVEN HIGH DESK



---

ELEVEN HIGH DESK



---

ELEVEN HIGH DESK



---

ELEVEN HIGH DESK ADJUSTABLE



---

ELEVEN HIGH DESK ADJUSTABLE

## DIMENSIONS

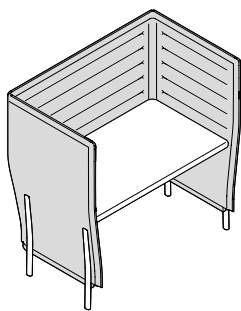

ELEVEN HIGH DESK / 885

cm 136x76 – h cm 137 – h top cm 72

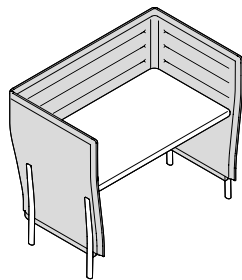

cm 136x76 – h cm 107 – h top cm 72

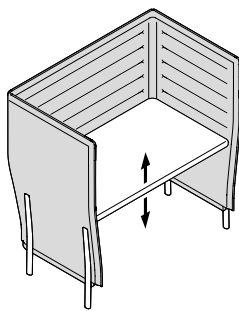

ELEVEN HIGH DESK ADJUSTABLE / 886

cm 136x76 – h cm 137 – h top cm 72-137

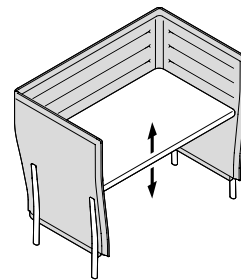

cm 136x76 – h cm 107 – h top cm 72-107

Su richiesta è disponibile il modulo di connessione elettrica.  
The electrical connection module is available on request.  
Das elektrische Anschlussmodul ist auf Anfrage erhältlich.  
Le module de connexion électrique est disponible sur demande.

## FINISHES

### STRUTTURA / STRUCTURE / GESTELL / STRUCTURE

Alluminio lucidato  
Polished Aluminium  
Aluminium poliert  
Aluminium poli



AB

Alluminio verniciato goffrato  
Textured lacquered aluminium  
Lackiertes gerauhtes Aluminium  
Aluminium laqué granité

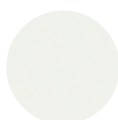

A019



A011



A047



A022



A051



A039



A041



A042

### PIANO / TOP / TISCHPLATTE / PLATEAU

Impiallacciato  
Veneered  
Furnierung  
Plaqué

Rovere naturale  
Natural oak  
Eiche  
Chêne naturel

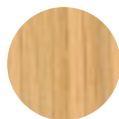

RV

Rovere grigio cenere  
Ash grey oak  
Eiche aschgrau  
Chêne gris cendré



RC

### RIVESTIMENTO PANNELLI / PANEL'S COVER / PANEELBEZUG / REVÊTEMENT PANNEAUX

Tessuti  
Fabric  
Stoff  
Tissu

**Alias® A**  
Living I  
Living II

**Camira® A**  
Xtreme  
Urban

**Kvadrat® B**  
Maple  
Remix  
Tonus

**Kvadrat® C**  
Canvas  
Divina  
Divina Melange  
Foss  
Hallingdal 65  
Harald  
Hero  
Steelcut  
Steelcut Trio  
Twill Weave



# FRAMETABLE

ALBERTO MEDA

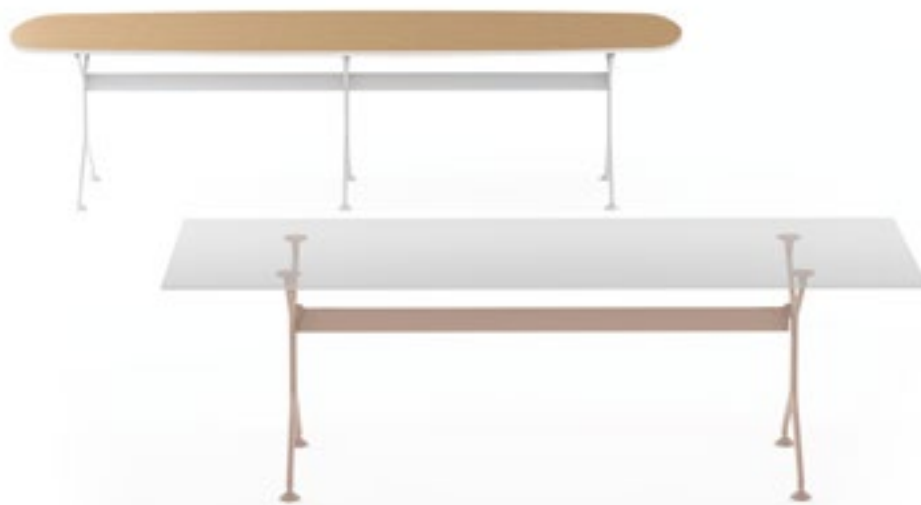

Perfetti per ogni spazio o edificio, pubblico o privato, storico o contemporaneo, i tavoli *frametable* sono caratterizzati dal design sobrio e dalla grande leggerezza formale. Disponibili nella versione fissa e pieghevole hanno struttura portante in alluminio pressofuso e piani rettangolari od ovali di varie dimensioni e finiture.

Ideal für jeden Raum und jedes Gebäude, öffentlich oder privat, historisch oder zeitgenössisch: *Frametable* Tische kennzeichnen sich durch schlichtes Design und außerordentlich formelle Leichtigkeit aus. In der Variante als feststehender oder klappbarer Tisch sind sie mit einem Gestell aus Aluminiumdruckguss und mit rechteckigen oder ovalen Platten in verschiedenen Abmessungen und Ausföhrungen verfügbar.

Perfect for any interior space or any kind of building, whether public or private, historical or modern, *frametable* features an essential design and a great formal lightness. Available in the fixed and folding version, with a bearing structure in die-cast aluminium and rectangular or oval tops in different sizes and finishes.

Idéales dans tout type d'espace et d'édifice public ou privé, historique ou contemporain, les tables *frametable* se caractérisent par leur sobre et leur grande légèreté formelle. Disponibles dans la version fixe et pliante, elles sont dotées d'une structure portante en aluminium moulé sous pression et des plateaux rectangulaires ou ovales de différentes dimensions et finitions.

# FRAMETABLE FOLDING 495



FRAMETABLE FOLDING 160F



FRAMETABLE FOLDING 190F



frametable folding trolley / 49Y  
available only 495



frametable folding wall base / 49Z  
available only 495



# OVERVIEW

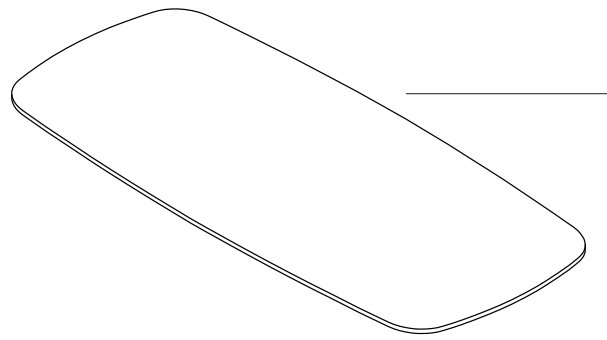

**Oval top (498 e 499) in:**

oak  
glass  
glass sandwich  
marble bianco Carrara (only for version 498 with top length 190 cm and 240 cm)

**Piano ovale (498 e 499) in:**

rovere  
vetro  
vetro double face  
marmo bianco Carrara (solo per la versione 498 con piano 190 cm e 240 cm)

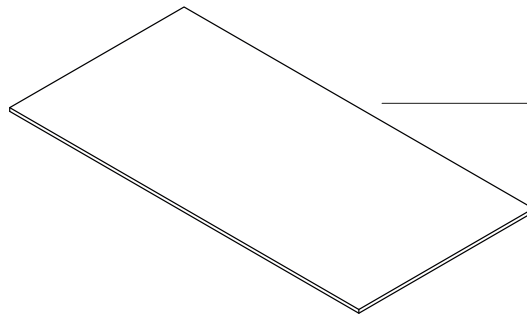

**Top (495 e 496) in:**

oak  
laminato  
glass (available for 496)  
glass sandwich (available for 496)

**Piano (495 e 496) in:**

rovere  
laminato  
vetro (disponibile solo 496)  
vetro double face (disponibile solo 496)

**Fixed structure:**  
The number of legs varies depending on the size of the top

**Struttura fissa:**  
Il numero delle gambe varia a seconda della dimensione del piano

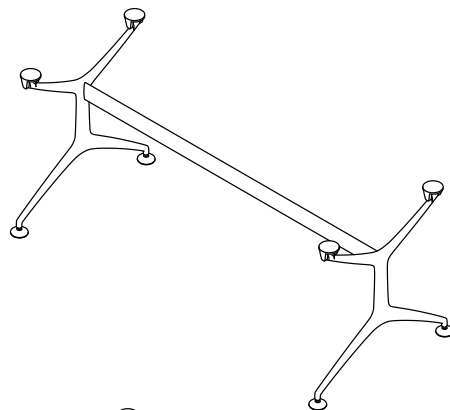

**Supports / supporto:**

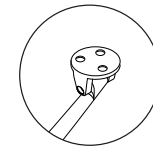

top fixed to the structure  
piano fissato alla struttura

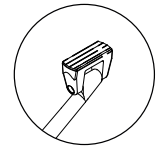

lying table top, no need for extra fixing (for glass and marble top)  
piano in appoggio (per piano in vetro e marmo)

**Folding structure**  
(495)

**Struttura pieghevole**  
(495)

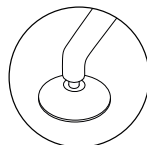
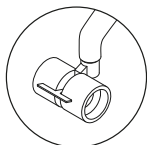
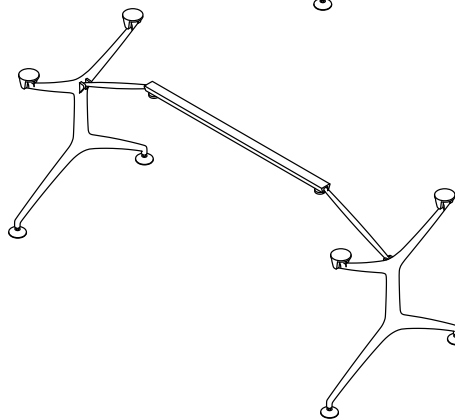

available with or without wheels  
disponibile con o senza ruote

## 498 / 498 dining

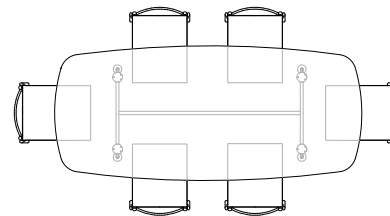
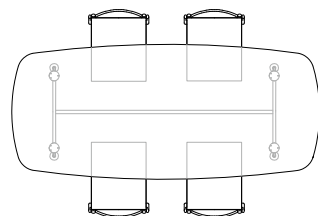

**Dining:**  
Version with possibility to have the seatplace at the head of the table.

**Dining:**  
Versione con possibilità di sedere a capotavola.

# FRAMETABLE 496



FRAMETABLE 160



FRAMETABLE 190



FRAMETABLE 240



FRAMETABLE 295XL



Discover all Frametable tables on **alias.design**  
Scopri tutti i tavoli Frametable su **alias.design**

# FRAMETABLE 498



FRAMETABLE 190 DINING



FRAMETABLE 240



FRAMETABLE 295XL

# FRAMETABLE 499

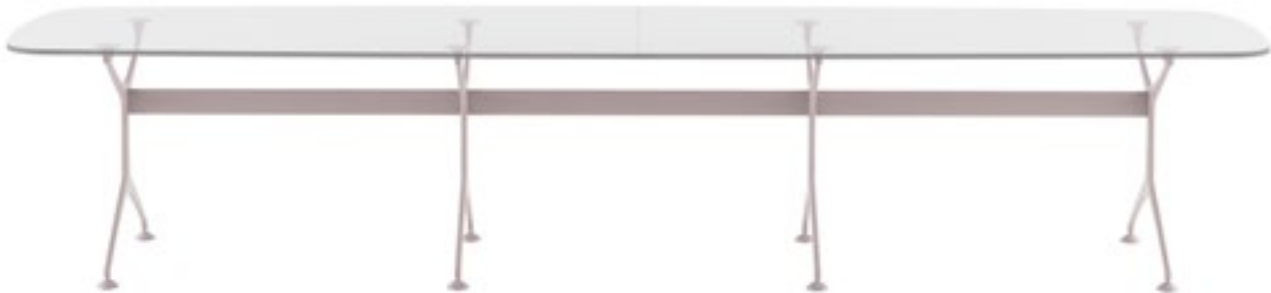

FRAMETABLE 499 / 380

## FRAMETABLE CABLE



### ACCESSORIES

per cablaggio tavoli frametable 496 / 498 / 499  
con piani in laminato o impiallacciato.  
Cabling accessories for frametable 496 / 498 / 499  
with top in laminate or oak veneer.

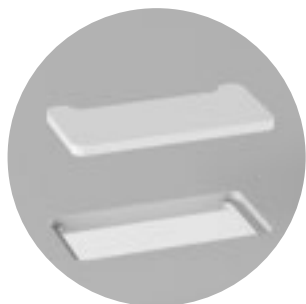

Foro passacavi e coperchio  
Cable hole and lid  
Bohrung für Kabeldurchlass und Deckel  
Trou passe-câbles et couverture



Vasca reggicavi in metallo verniciato  
Cable tray in lacquered metal  
Kabelwanne aus lackiertem Metall  
Support passe-câbles en métal laqué

Su richiesta, è possibile aggiungere il modulo di connessione elettrica e il sistema di canalizzazione da piano per raggruppare i cavi.

On request it is possible to add the electrical connection module and the cable channeling system.

Auf Anfrage ist es möglich, das Modul für den elektrischen Anschluss und das Kabel-Kanalierungssystem einzufügen.

Sur demande, le module de connexion électrique et le système de canalisation pour regrouper les câbles peuvent être ajoutés.

## EXAMPLES OF FRAMETABLE CABLE MANAGEMENT 49X POSITIONS



frametable 160 / 496\_160

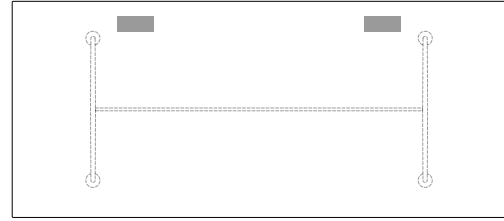

frametable 240 / 496\_240

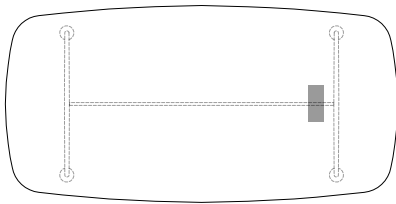

frametable oval 190 / 498\_190

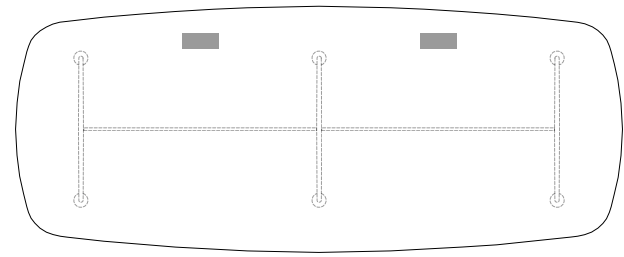

frametable oval 295XL / 498\_295XL

■ Esempi posizionamento di 49X  
Positioning examples of 49X  
Positionierungsbeispiele für 49X  
Exemples de positionnement du 49X

La collezione *frametable* firmata da Alberto Meda si completa con piani dotati di foro passacavi con coperchio, che consente di corredare lo storico tavolo con diversi accessori, trasformandolo in una perfetta workstation. I piani *frametable* grazie agli accessori consentono la creazione di postazioni di lavoro versatili senza perdere la leggerezza formale che contraddistingue la collezione.

The *frametable* collection designed by Alberto Meda is completed by table tops set up with a cable hole with a lid, which allows the historical table to be equipped with various accessories, transforming it into a perfect workstation. Thanks to their accessories, the *frametable* tops make it possible to create versatile workstations without losing the collection distinctive formal lightness.

Die von Alberto Meda signierte Kollektion *frametable* wird durch Tischplatten mit Kabelauslass mit Deckel ergänzt: Diese ermöglichen die Ausstattung des historischen Tisches mit verschiedenen Zubehörteilen, der sich dadurch in eine perfekte Work Station verwandelt. Dank der Zubehörteile ermöglichen die *frametable* Tischplatten die Schaffung vielseitiger Arbeitsplätze, ohne dabei auf die formelle Leichtigkeit dieser Kollektion zu verzichten.

La collezione *frametable*, conçue par Alberto Meda, est complétée par les plateaux équipés d'un passe-câbles avec clapet qui permet d'équiper cette table historique de différents accessoires pour en faire ainsi le poste de travail idéal. Grâce à leurs accessoires, les plateaux *frametable* permettent de créer des postes de travail polyvalents sans renoncer à la légèreté formelle qui caractérise la collection.

# DIMENSIONS

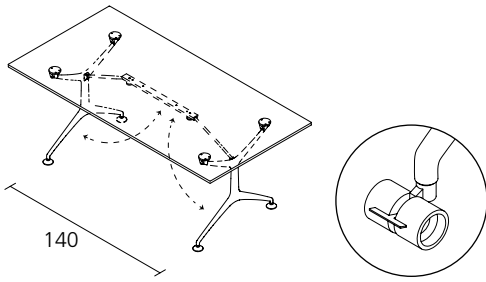

FRAMETABLE FOLDING / 495

cm 160x80 / 190x95 - h cm 73,5  
available with or without wheels  
disponibile con o senza ruote

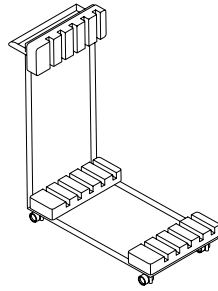

FRAMETABLE FOLDING TROLLEY / 49Y

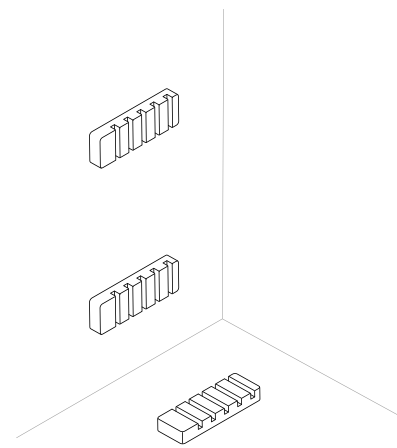

FRAMETABLE FOLDING WALL BASE / 49Z

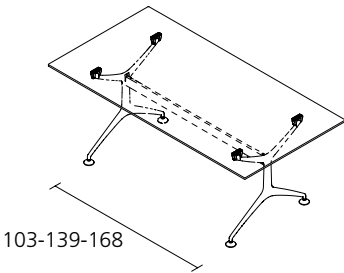

FRAMETABLE / 496

cm 160x80 / 190x95 / 240x105 - h cm 73,5

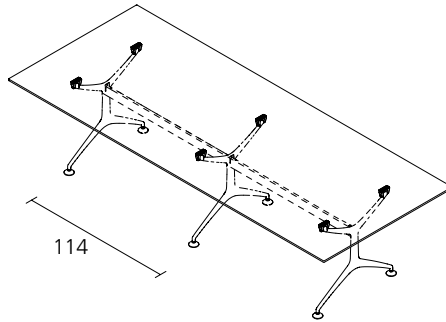

FRAMETABLE 496 / 295XL

cm 295x120 - h cm 73,5

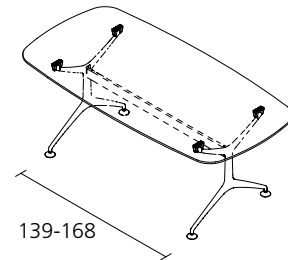

FRAMETABLE OVAL / 498

cm 190x95 / 240x105 - h cm 73,5

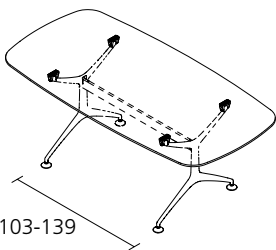

FRAMETABLE / 498 DINING

cm 190x95 / 240x105 - h cm 73,5

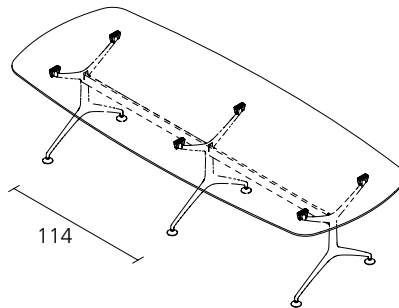

FRAMETABLE / 498 295XL

cm 295x120 - h cm 73,5

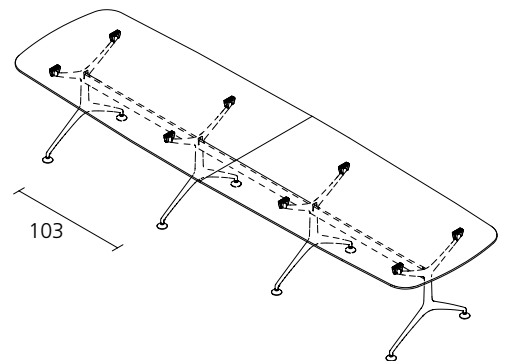

FRAMETABLE OVAL / 499

cm 380x105 / 480x120 - h cm 73,5



# FINISHES

## STRUTTURA / STRUCTURE / GESTELL / STRUCTURE

Alluminio lucidato  
Polished Aluminium  
Aluminium Poliert  
Aluminium poli



AB

Alluminio verniciato goffrato  
Textured lacquered aluminium  
Lackiertes gerauhtes Aluminium  
Aluminium laqué granité



A019

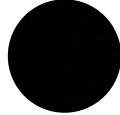

A011



A047



A022



A051



A039



A041



A042

## PIANO / TOP / TISCHPLATTE / PLATEAU

Laminato  
Laminate  
Laminat  
Laminé

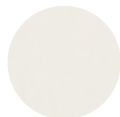

L010

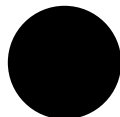

L006



L005

Disponibile solo per 496 / 498 / 499  
Available only for 496 / 498 / 499  
Verfügbar nur für 496 / 498 / 499  
Disponible uniquement pour 496 / 498 / 499

Vetro  
Glass  
Glas  
Verre



VTT

Disponibile solo per 496 / 498 / 499  
Available only for 496 / 498 / 499  
Verfügbar nur für 496 / 498 / 499  
Disponible uniquement pour 496 / 498 / 499

Vetro double face  
Glass double face  
Glas beidseitig  
Verre doubleface



DB01



DB02



DB03

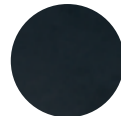

DB05

Disponibile solo per 496 / 498 / 499  
Available only for 496 / 498 / 499  
Verfügbar nur für 496 / 498 / 499  
Disponible uniquement pour 496 / 498 / 499

Impiallacciato  
Veneered  
Furnierung  
Plaqué

Rovere naturale  
Natural oak  
Eiche  
Chêne naturel

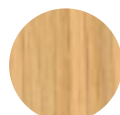

RV

Rovere sbiancato  
Whitened oak  
Eiche gebleicht  
Chêne blanchi



RVS

Rovere grigio cenere  
Ash grey oak  
Eiche aschgrau  
Chêne gris cendré



RC

Rovere scuro  
Dark oak  
Eiche dunkel  
Chêne foncé



RVT

Marmo bianco di Carrara  
Marble bianco Carrara  
Marmor bianco Carrara  
Marbre bianco Carrara



MA01

Disponibile solo per frametable oval 190 / 240  
Available only for frametable oval 190 / 240  
Verfügbar nur für frametable oval 190 / 240  
Disponible uniquement pour frametable oval 190 / 240

Frametable 495 e 496 piano in alluminio alveolare  
Frametable 495 and 496 with top in alveolar aluminium  
Frametable 495 und 496 mit Platte aus Aluminium in Wabenstruktur  
Frametable 495 et 496 plateau en aluminium alvéolaire





# FRAMETABLE MEETING

ALBERTO MEDA



*Frametable meeting*, una collezione di tavoli disegnata da Alberto Meda che si adatta alle svariate esigenze dell'ufficio contemporaneo, sempre più dinamico e multifunzionale. I tavoli, ideali per i momenti di lavoro in condivisione, rispondono in modo intelligente alle necessità delle sale riunioni.

*Frametable meeting*, eine von Alberto Meda designte Tischkollektion, die sich an die unterschiedlichen Bedürfnisse des modernen, immer dynamischeren und multifunktionalen Büros anpasst. Die Tische sind ideal für Momente der gemeinsamen Arbeit und bieten eine intelligente Antwort auf die Bedürfnisse in Sitzungsräumen.

*Frametable meeting*, a table collection designed by Alberto Meda that adapts to the various needs of the contemporary office, increasingly dynamic and multifunctional. The tables, ideal for shared working sessions, are a smart response to the needs of meeting rooms.

*Frametable meeting*, une collection de tables dessinée par Alberto Meda qui s'adapte aux différents besoins du bureau contemporain, toujours plus dynamique et multifonctions. Idéales pour les moments de travail partagés, les tables frametable meeting, sont une réponse intelligente aux besoins des salles de réunion.

## FRAMETABLE MEETING



FRAMETABLE MEETING 295

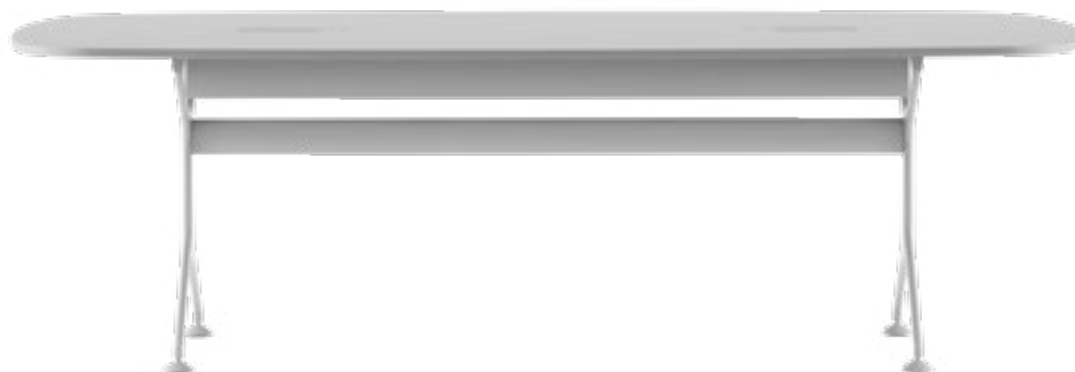

FRAMETABLE MEETING 240 OVAL

La solida struttura portante composta da elementi in alluminio pressofuso, che caratterizza l'iconica collezione, sostiene i nuovi piani, proposti nei formati rettangolari ed ovali, realizzati in MDF laminato o impiallacciato in precomposto di rovere. Disponibile con profondità 140 cm, nelle lunghezze cm 240 e cm 295, i piani di *frametable meeting* sono dotati di foro passacavi con coperchio e lamiera raccogli cavi strutturale posizionata sotto il top.

The solid load-bearing structure made of die-cast aluminium elements, a hallmark of the iconic collection, supports the new tops proposed in rectangular and oval shapes and made of laminated MDF or oak veneer plywood. The *frametable meeting* tops are available with a depth of 140 cm and in two lengths, 240 cm and 295 cm; they are equipped with a cable hole with a lid and a structural cable holder plate positioned under the top.

Die solide Tragestruktur, die aus Aluminiumdruckgusselementen besteht und die ikonische Kollektion kennzeichnet, stützt die neuen Tischplatten, erhältlich in den Formaten Rechteckig und Oval und aus laminiertem oder Eichenfurniertem MDF. Die Tischplatten für *frametable meeting* sind mit 140 cm Tiefe und in den Längen 240 cm und 295 cm verfügbar und sind mit den folgenden Zubehör ausgestattet: Kabelauslass mit Deckeln und in der Struktur integriertem Kabelhalter-Blechwanne fixiert unter der Tischplatte.

Caractéristique de cette collection emblématique, une solide structure portante composée d'éléments en aluminium moulé sous pression soutient les nouveaux plateaux, proposés dans des formats rectangulaires et ovales, en MDF laminé ou plaqué en chêne pré-composé. Disponibles avec une profondeur de 140 cm et une longueur de 240 cm ou 295 cm, les plateaux *frametable meeting* sont équipés d'un trou passe-câbles avec couverture et d'une collectrice de câbles en tôle, positionnée sous le plateau.

## POSITION OF THE WIRED MODULES

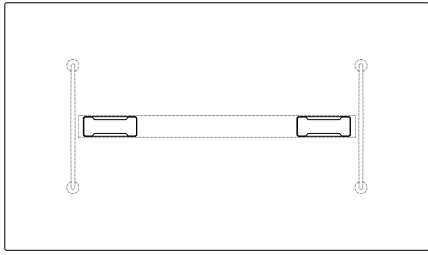

frametable meeting 240 / **FM1\_240**  
cm 240x140 - h. cm 73,5

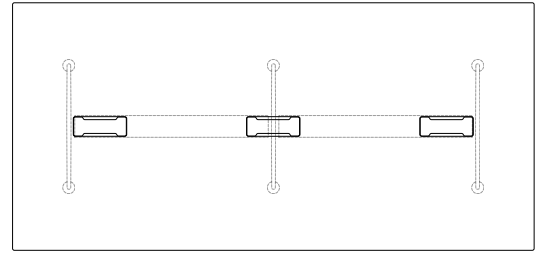

frametable meeting 295 / **FM1\_295**  
cm 295x140 - h. cm 73,5

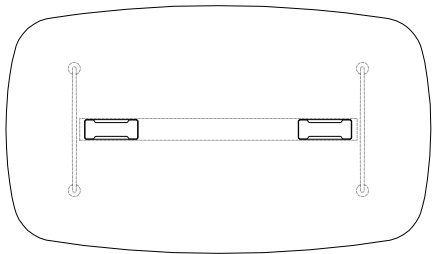

frametable meeting 240 oval / **FM2\_240**  
cm 240x140 - h. cm 73,5

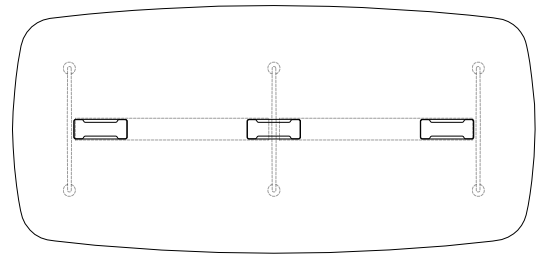

frametable meeting 295 oval / **FM2\_295**  
cm 295x140 - h. cm 73,5

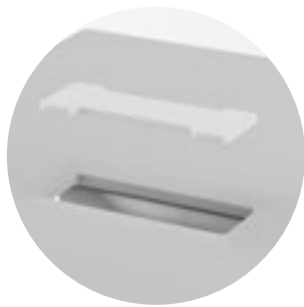

Foro passacavi e coperchio  
Cable hole and lid  
Bohrung für Kabeldurchlass und Deckel  
Trou passe-câbles et couverture



Vasca reggicavi in metallo verniciato  
Cable tray in lacquered metal  
Kabelwanne aus lackiertem Metall  
Goulotte passe-câbles en métal laqué

Su richiesta, è possibile aggiungere il modulo di connessione elettrica e il sistema di canalizzazione da piano per raggruppare i cavi.

On request it is possible to add the electrical connection module and the cable channeling system.

Auf Anfrage ist es möglich, das Modul für den elektrischen Anschluss und das Kabel-Kanalierungssystem einzufügen.

Sur demande, le module de connexion électrique et le système de canalisation pour regrouper les câbles peuvent être ajoutés.

# DIMENSIONS

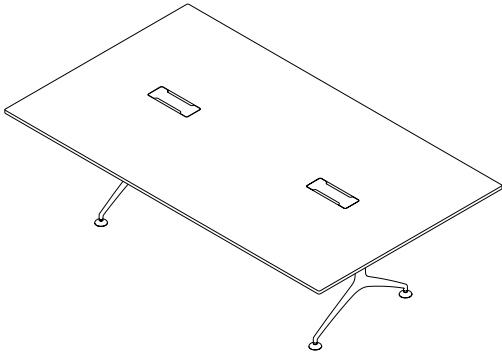

FRAMETABLE MEETING 240 / FM1\_240

cm 140x240 - h cm 73,5

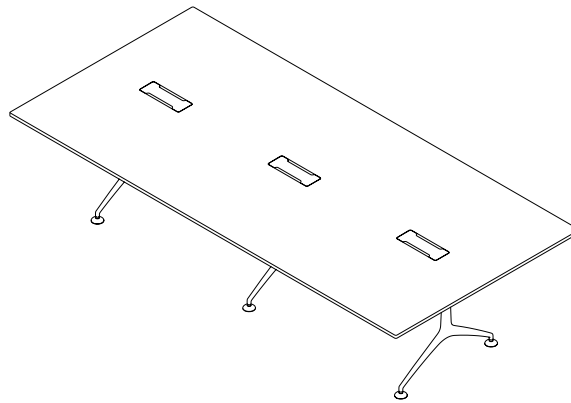

FRAMETABLE MEETING 295 / FM1\_295

cm 140x295 - h cm 73,5

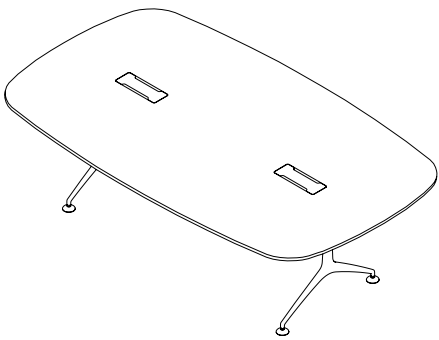

FRAMETABLE MEETING 240 OVAL / FM2\_240

cm 140x240 - h cm 73,5

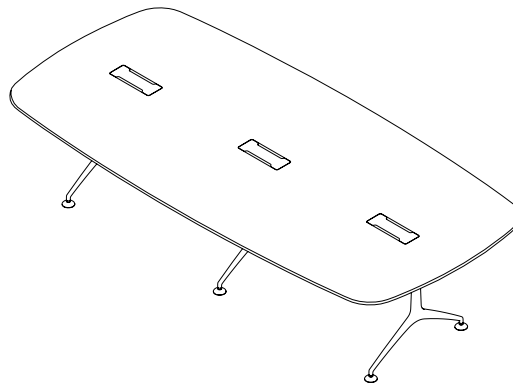

FRAMETABLE MEETING 295 OVAL / FM2\_295

cm 140x295 - h cm 73,5

## Schema number of workstation Meetingframe 52

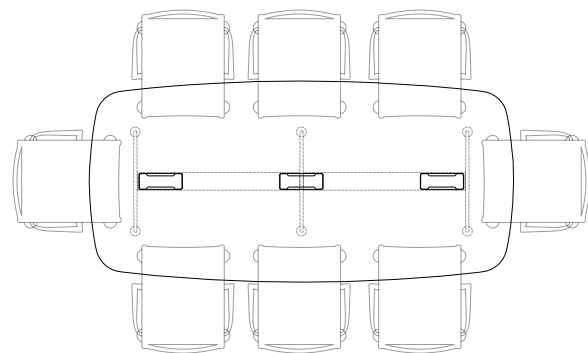
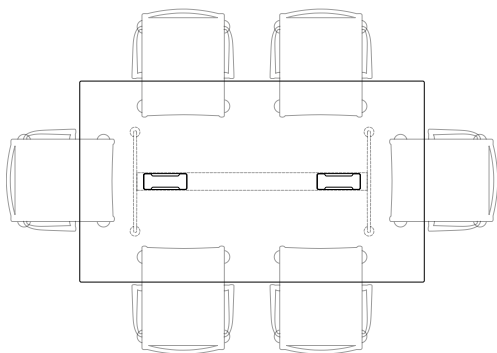

# FINISHES

## STRUTTURA / STRUCTURE / GESTELL / STRUCTURE

Alluminio lucidato  
Polished Aluminium  
Aluminium Poliert  
Aluminium poli



AB

Alluminio verniciato goffrato  
Textured lacquered aluminium  
Lackiertes gerauhtes Aluminium  
Aluminium laqué granité



A019



A011



A047



A022



A051



A039



A041



A042

## PIANO IN MDF / TOP IN MDF / TISCHPLATTE AUS MDF / PLATEAU EN MDF

Laminato  
Laminate  
Laminat  
Laminé

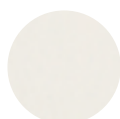

L010

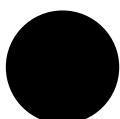

L006



L005

Impiallacciato  
Veneered  
Furnierung  
Plaqué

Rovere naturale  
Natural oak  
Eiche  
Chêne naturel

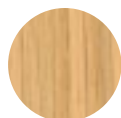

RV

Rovere sbiancato  
Whitened oak  
Eiche gebleicht  
Chêne blanchi

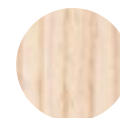

RVS

Rovere grigio cenere  
Ash grey oak  
Eiche aschgrau  
Chêne gris cendré



RC

Rovere scuro  
Dark oak  
Eiche dunkel  
Chêne foncé



RVT

## NOTA VASCA.

Il colore della vasca è abbinato al colore del piano o della struttura secondo questi abbinamenti:

- piano in laminato: la vasca è abbinata al colore del piano
- piano in rovere e struttura verniciata: la vasca è del colore della struttura
- piano in rovere e struttura lucida: la vasca è verniciata sabbia (A047) con piano in rovere naturale o sbiancato; la vasca è verniciata grigio grafite (A022) con piano in rovere scuro o grigio cenere.

## NOTE FOR TRAY.

The colour of the tray matches the colour of the top or of the structure following these combinations:

- top in laminate: the tray matches the colour of the top
- top in oak and lacquered structure: the tray matches the colour of the structure
- top in oak and polished structure: if the top is in natural or whitened oak, the tray is lacquered sand (A047); if the top is in dark or ashgrey oak, the tray is lacquered graphite grey (A022).

## HINWEIS FÜR DIE WANNE.

Die Farbe der Wanne hängt von der Farbe der Platte oder des Gestelles ab und folgt diese Kombinationen:

- Platte aus Laminat: Die Wanne ist mit der Farbe der Platte kombiniert
- Platte aus Eiche und lackiertes Gestell: Die Wanne ist mit der Farbe des Gestelles kombiniert
- Platte aus Eiche und poliertes Gestell: Wanne lackiert sand (A047) mit Platte aus Eiche natur oder gebleicht; Wanne lackiert graphitgrau (A022) mit Platte aus Eiche dunkel oder aschgrau.

## NOTE POUR LA GOULOTTE.

La couleur de la goulotte est assortie à la couleur du plateau ou de la structure selon ces combinaisons :

- plateau avec laminé : la goulotte est assortie à la couleur du plateau.
- plateau en chêne et structure laquée : la goulotte est de la même couleur que la structure
- plateau en chêne et structure polie : la goulotte est laquée sable (A047) avec un plateau en chêne naturel ou blanchi ; la goulotte est laquée gris graphite (A022) avec un plateau en chêne foncé ou gris cendré.



# FRAMETABLE SYSTEM

ALBERTO MEDA



*Frametable*, il tavolo icona di Alias, diventa un sistema grazie all'introduzione degli elementi curvi ad angolo di 60 gradi e rettangolari che, se accostati l'uno all'altro, permettono di creare svariate configurazioni ideali per situazioni meeting, conference e postazioni di lavoro in serie. Tutti i moduli di *frametable system* sono disponibili anche con piano dotato di foro passacavi con coperchio e possono essere accessorizzati con i diversi elementi disponibili per la collezione *frametable*.

*Frametable*, Alias ikonischen Tisch, wird zu einem echten System dank der Einführung von neuen Elementen mit 60°-runde oder rechteckigen Platten. Durch die Kombination dieser Teile miteinander wird die Kreation von verschiedenen Konfigurationen, ideal für Besprechungs- und Konferenzen, und Arbeitsplätze in Reihen ermöglicht. Alle Module sind auch mit Tischplatten mit Kabelauslass und Deckel erhältlich und können mit den verschiedenen Elementen der *frametable* Kollektion ausgestattet werden.

*Frametable*, Alias iconic table, has become a system thanks to the introduction of new 60° curved elements and rectangular elements which can be placed side by side and permit a variety of configurations, ideal for meetings, conferences and workstations in a series. All modules of *frametable system* are also available with a top equipped with a cable hole with a lid and can be accessorised with the various elements available for the *frametable* collection.

*Frametable*, la table iconique de Alias, devient un système grâce à l'introduction des éléments incurvés à angle de 60 degrés et rectangulaires qui, une fois combinés entre eux, permettent de créer différentes configurations idéales pour les situations de réunion, conférence et les postes de travail en série. Tous les modules sont également disponibles avec un plateau doté d'un passe-câbles avec couverture et peuvent être complétés par les différents éléments disponibles pour la collection *frametable*.

## FRAMETABLE SYSTEM

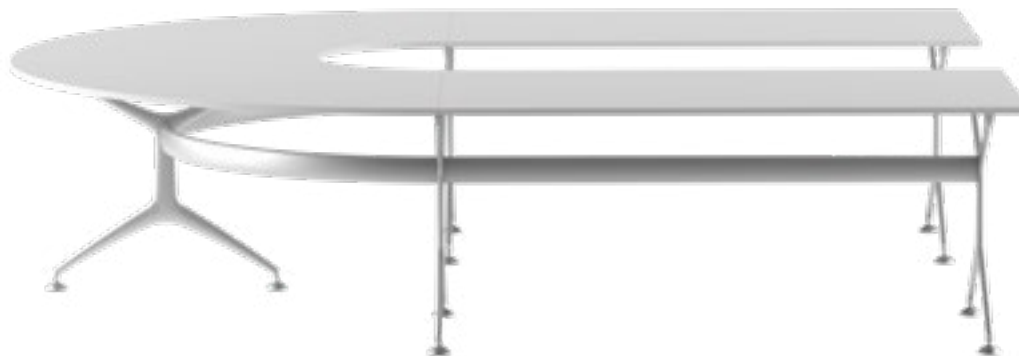

INITIAL RECTANGULAR MODULE + n. 02 CENTRAL CURVED MODULE +  
FINAL RECTANGULAR MODULE



n. 06 CENTRAL CURVED MODULE

I nuovi piani curvi e rettangolari sono realizzati in multistrato, laminato o impiallacciato, e sono proposti in tre moduli differenti: modulo centrale, di apertura e di chiusura. Per i moduli curvi di apertura e di chiusura sono previste le varianti destra e sinistra a seconda della direzione di curvatura; il modulo centrale si adatta ad entrambe le configurazioni.

The new curved and rectangular tops are made of laminated or veneered plywood and are available in three different modules: initial, central and final module. A right or left initial curved module is available and you can choose it according to the direction of the curvature, while the central module fits both configurations.

Die neuen gebogenen und rechteckigen Tischplatten sind aus laminiertem oder furniertem Multiplex und werden drei unterschiedliche Module angeboten: Anfangs-, End- und Zentral-Modul. Es gibt eine linke und eine rechte Variante der gebogenen Module je nach der Krümmungsrichtung; das Zentral-Modul passt zu beide Konfigurationen.

Les nouveaux plateaux courbes et rectangulaires sont fabriqués en contreplaqué, laminé ou en placage, et sont proposés en trois modules différents : module central, module d'ouverture et module de fermeture. Pour les modules d'ouverture et de fermeture courbes, les variantes droite et gauche sont prévues selon le sens de courbure; le module central s'adapte aux deux configurations.



# EXAMPLES OF CONFIGURATIONS

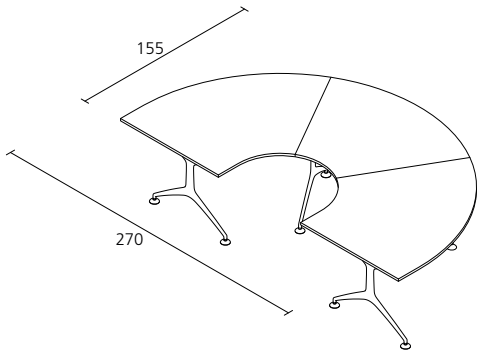

initial curved module + central curved module + final curved module

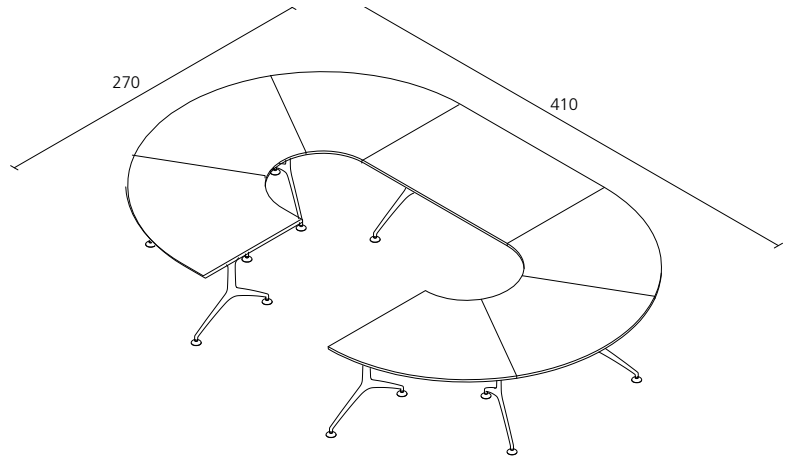

initial curved module + n. 04 central curved module + central rectangular module + final curved module

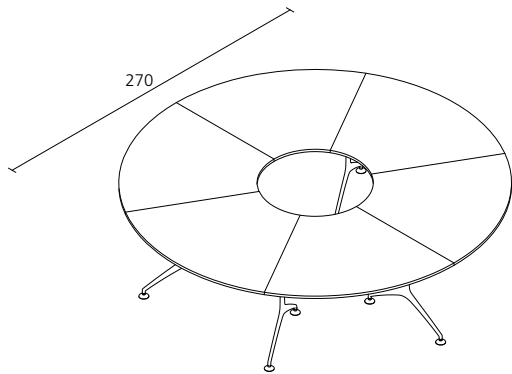

n. 06 central curved module

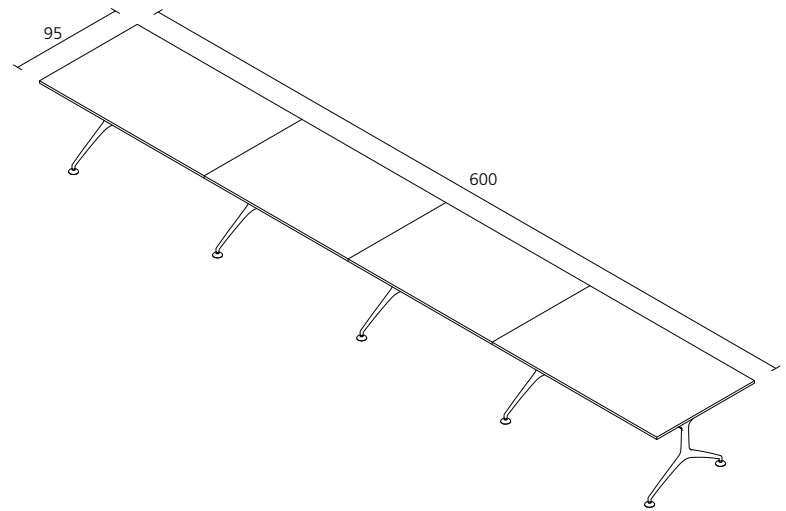

initial rectangular module + no. 02 central rectangular modules + final rectangular module

## Schema number of workstation Meetingframe 52

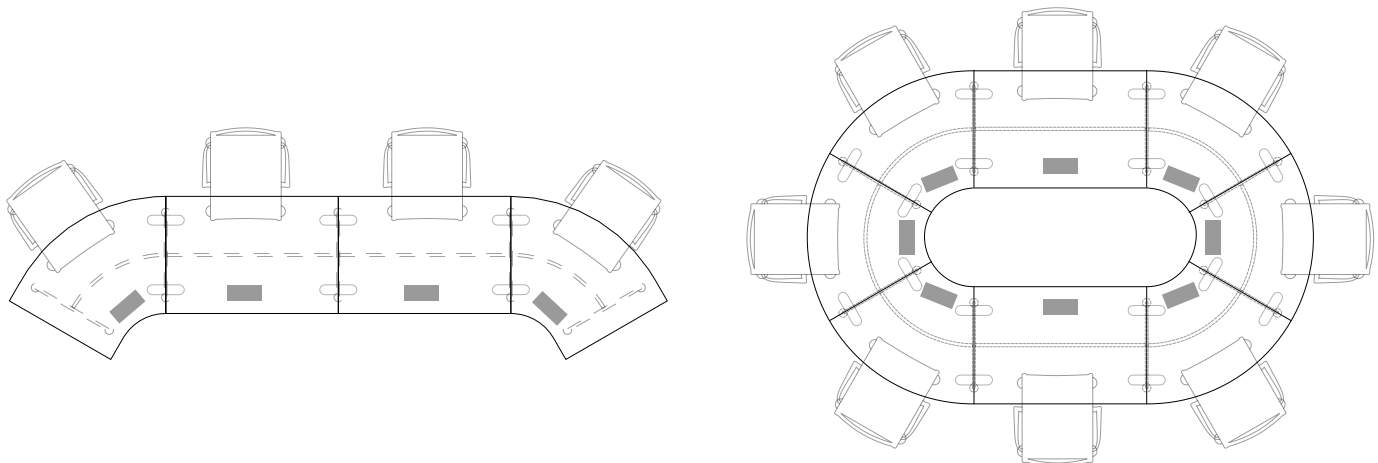

## DIMENSIONS

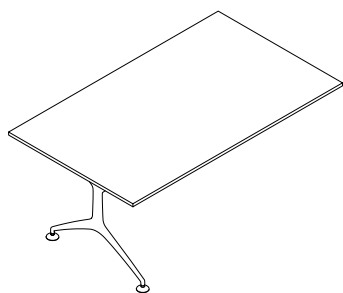

FRAMETABLE SYSTEM / 49R\_I

cm 160x95 - h cm 73,5

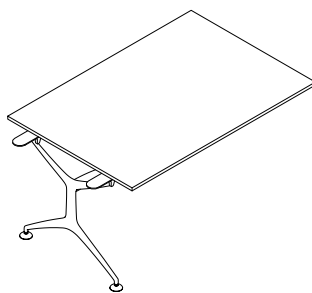

FRAMETABLE SYSTEM / 49R\_C

cm 140x95 - h cm 73,5

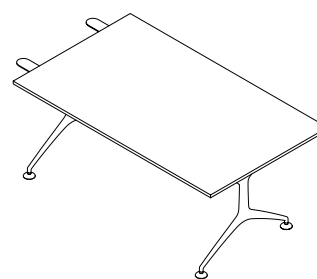

FRAMETABLE SYSTEM / 49R\_F

cm 160x95 - h cm 73,5

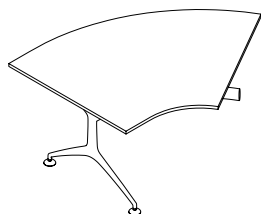

FRAMETABLE SYSTEM / 49C\_I

cm 153x95 - h cm 73,5

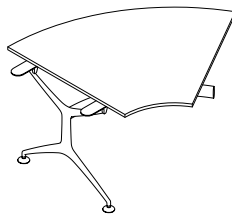

FRAMETABLE SYSTEM / 49C\_C

cm 135x95 - h cm 73,5

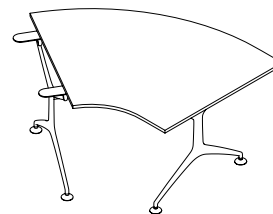

FRAMETABLE SYSTEM / 49C\_F

cm 153x95 - h cm 73,5

## ACCESSORIES

su richiesta, è possibile predisporre il piano per la versione cabalata  
on request it is possible to prepare the top for the cabled version

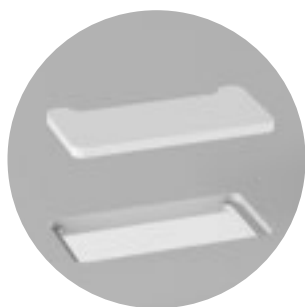

Foro passacavi e coperchio  
cable hole and lid  
Bohrung für Kabeldurchlass und Deckel  
Trou passe-câbles et couverture



Vasca reggicavi in metallo verniciato  
Cable tray in lacquered metal  
Kabelwanne aus lackiertem Metall  
Support passe-câbles en métal laqué

Su richiesta, è possibile aggiungere il modulo di connessione elettrica e il sistema di canalizzazione da piano per raggruppare i cavi.

On request it is possible to add the electrical connection module and the cable channeling system.

Auf Anfrage ist es möglich, das Modul für den elektrischen Anschluss und das Kabel-Kanalierungssystem einzufügen.

Sur demande, le module de connexion électrique et le système de canalisation pour regrouper les câbles peuvent être ajoutés.

# FINISHES

## STRUTTURA / STRUCTURE / GESTELL / STRUCTURE

Alluminio lucidato  
Polished Aluminium  
Aluminium Poliert  
Aluminium poli



AB

Alluminio verniciato goffrato  
Textured lacquered aluminium  
Lackiertes gerauhtes Aluminium  
Aluminium laqué granité



A019



A011



A047



A022



A051



A039



A041

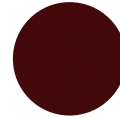

A042

## PIANO IN MULTISTRATO / TOP IN PLYWOOD / TISCHPLATTE AUS MULTIPLEX / PLATEAU EN MULTICOUCHE

Laminato  
Laminate  
Laminat  
Laminé

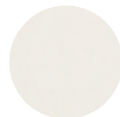

L010

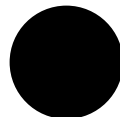

L006



L005

Impiallacciato  
Veneered  
Furnierung  
Plaqué

Rovere naturale  
Natural oak  
Eiche  
Chêne naturel



RV

Rovere sbiancato  
Whitened oak  
Eiche gebleicht  
Chêne blanchi

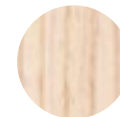

RVS

Rovere grigio cenere  
Ash grey oak  
Eiche aschgrau  
Chêne gris cendré



RC

Rovere scuro  
Dark oak  
Eiche dunkel  
Chêne foncé



RVT



# HIWOOD

GABRIELE & OSCAR BURATTI



Dalla conoscenza di Gabriele e Oscar Buratti delle lavorazioni del legno nasce *hiwood*, un progetto che esplora il mondo della tecnologia produttiva e le nuove espressioni formali che essa consente. *Hiwood* è un tavolo in multistrato impiallacciato di rovere che viene rastremato in tutte le sue parti diventando foglio sottilissimo di essenza: un segno architettonico essenziale ed archetipo in cui gli spessori si azzerano, creando così una geometria ridotta al minimo, tesa e particolare.

Aus den Kenntnissen in der Holzbearbeitung von Gabriele und Oscar Buratti entsteht *hiwood*, ein Projekt, das die Welt der Produktionstechnologie und die neuen formalen Ausdrucksformen, die sie ermöglicht, erforscht. *Hiwood* ist ein Tisch aus Multischicht Eichenfurnier, der in allen Teilen verjüngt wird und eine extrem dünne Holzfolie wird: ein wesentliches und archetypisches architektonisches Zeichen, bei dem die Dicken auf null reduziert sind. Dadurch entsteht eine auf ein Minimum reduzierte, straffe und besondere Geometrie.

From Gabriele and Oscar Buratti's experience in the field of woodwork comes *hiwood*, a project that explores the world of manufacturing technologies and the new formal expressions made possible by them. *Hiwood* is a table in oak veneered plywood that is tapered in all its parts and becomes an extremely thin sheet of wood: an essential and archetypal architectural sign in which thicknesses are reduced to zero, thus creating a geometry that is reduced to a minimum, stretched and particular.

De la connaissance de Gabriele et Oscar Buratti du travail du bois est née *hiwood*, une création qui explore l'univers de la technologie de production et les nouvelles expressions formelles qu'elle permet. *Hiwood* est une table en contreplaqué plaqué chêne, dont toutes les parties sont effilées pour devenir une feuille de bois extrêmement fine: un signe architectural essentiel et archétype dans lequel les épaisseurs sont réduites à zéro, créant ainsi une géométrie réduite au minimum, tendue et particulière.

# HIWOOD



La stabilità di *hiwood* è garantita da una struttura nascosta, tiranti e sottosquadra in acciaio che oltre a dare rigidità, consentono di ottenere incastri sofisticati e precisi. Il risultato è un progetto di forte spirito tecnico che connota un tavolo puro, elegante ed estremo: nel suo disegno, nella sua tecnica, nella sua classicità.

The stability of *hiwood* is guaranteed by a hidden structure, steel tie-rods and undercuts that not only provide rigidity, but also create sophisticated and precise joints. The result is a project with a strong technical spirit that connotes a pure, elegant and extreme table in its design, technique and classicism.

Die Stabilität von *hiwood* wird durch eine versteckte Struktur, Zugstangen und Hinterschnedigungen aus Stahl gewährleistet, die nicht nur für Steifigkeit sorgen, sondern auch ausgeklügelte und präzise Verbindungen ermöglichen. Das Ergebnis ist ein Projekt mit einem starken technischen Geist, das in seinem Design, in seiner Technik, in seinem Klassizismus einen reinen, eleganten und extremen Tisch darstellt.

La stabilité de *hiwood* est garantie par une structure cachée, des tirants et des contre-dépouilles en acier qui, en plus de donner rigidité, permettent d'obtenir des articulations sophistiquées et précises. Le résultat est un projet d'un fort esprit technique qui évoque une table pure, élégante et extrême: dans son dessin, dans sa technique, dans son classicisme.

# INTERIOR SOLUTIONS



**HIWOOD**  
FINISHES: WOOD (RV)  
**ELLE ARM SOFT**  
FINISHES: TEXTURED LACQUEURED ALUMINIUM (A011) POLYURETHANE TECH (PH01) FABRIC KVADRAT®

## DIMENSIONS

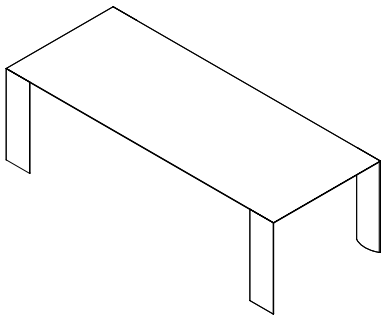

HIWOOD / 053

cm 100x200/250/295 - h cm 73,5

## FINISHES

Legno  
Wood  
Holz  
Bois

Rovere naturale  
Natural oak  
Eiche natur  
Chêne naturel



RV

Rovere grigio cenere  
Ash grey oak  
Eiche aschgrau  
Chêne gris cendré



RC

Rovere scuro  
Dark oak  
Eiche dunkel  
Chêne foncé



RVT





# ILVOLO

RICCARDO BLUMER



Declinazioni del concetto di leggerezza sono i tavoli *ilvolo* che hanno struttura in legno massello e impiallacciatura in varie essenze, oppure laccatura a poro aperto. Accostabile agli altri pezzi della collezione *laleggera*, in finiture identiche o assortite, disponibile nella versione fissa o allungabile in diverse dimensioni, i tavoli *ilvolo* sono molto maneggevoli e adatti sia in spazi domestici che collettivi.

Eine Interpretation des Begriffs der Leichtigkeit haben die *ilvolo* Tische eine Struktur aus Massivholz und sind furniert mit verschiedenen Holzarten oder offenporig lackiert. Sie lassen sich mit den anderen Stücke der *laleggera* Kollektion kombinieren, entweder mit der gleichen Essenz oder in einer anderen ausgewählten Ausführungen. Erhältlich in der Fixen oder ausziehbaren Version und mit unterschiedlichen Abmessungen sind die Tische *ilvolo* sehr handlich im Gebrauch und sind sowohl für das Wohnbereich als auch für Versammlungsräume geeignet.

*Ilvolo* tables represent a different dimension to the concept of "lightness". Tables composed by a solid wooden structure veneered in a range of wood finishes, or coloured stains to be matched to the *laleggera* collection, in the same finishes or mixed finishes. Available in different dimensions and in the fixed or extendable version, *ilvolo* tables are lightweight and therefore manageable and ideal for both domestic and work areas.

Déclinaisons du concept de légèreté sont les tables *ilvolo* qui ont une structure en bois massif et placage en différentes essences, ou laquage à pore ouvert. Il est possible de les associer aux autres pièces de la collection *laleggera*, en finitions identiques ou assorties, et sont disponibles en version fixe ou allongeable, en différentes dimensions. Les tables *ilvolo* sont très maniables et conviennent également à des lieux domestiques ou à des collectivités.

ILVOLO



ILVOLO



ILVOLO EXTENDABLE

## DIMENSIONS

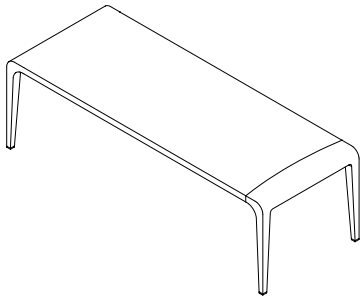

ILVOLO / 390

cm 90x90/180/240 - h cm 73

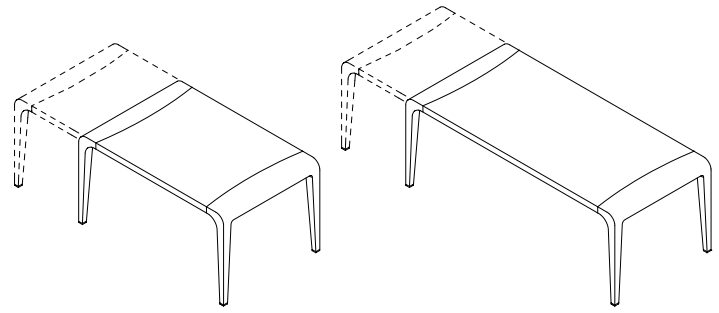

ILVOLO EXTENDABLE / 396

cm 90x133,5 ↔ 193,5 - h cm 73  
cm 90x193,5 ↔ 253,5 - h cm 73

*Ilvolo* è proposto con impiallacciatura in varie essenze o laccatura a poro aperto nei colori sabbia, bianco e nero.

*Ilvolo* is offered with different wood veneers, or in the stained colours sand, black and white.

*Ilvolo* ist in verschiedenen Holzfurnieren erhältlich, oder offenporig lackiert sand, schwarz und weiß.

*Ilvolo* est proposée avec placage de différentes essences ou laquage à pore ouvert dans les coloris sable, noir et blanc.

## FINISHES

Legno  
Wood  
Holz  
Bois

Acero naturale  
Natural maple  
Ahorn natur  
Erable naturel



ACN

Rovere  
Oak  
Eiche  
Chêne



RV

Rovere tinto  
Stained oak  
Eiche gebeizt  
Chêne teinté

Rovere noce canaletto  
canaletto walnut oak  
Eiche canaletto nußbaum  
Chêne noyer canaletto



NCT

Rovere sbiancato  
White oak  
Eiche gebleicht  
Chêne blanchi



RVS

Rovere grigio cenere  
Ash grey oak  
Eiche aschgrau  
Chêne gris cendré



RC

Verniciatura a poro aperto  
Coloured stains  
Offenporig lackiert  
Laquage à pore ouvert



V131



V140



V142



# LANDSCAPE

SIMON PENGELLY



*Landscape*, il sistema per ufficio flessibile e funzionale che offre ampia possibilità di utilizzo, integrandosi armoniosamente negli ambienti di lavoro. Realizzato attraverso avanzate tecnologie e complesse lavorazioni industriali, *landscape* risponde in modo concreto alle svariate richieste del mondo ufficio, declinandosi in diversi elementi che comprendono tavoli, postazioni operative e cassettiere, caratterizzati da linee morbide e volumi raffinati.

*Landscape*, ein flexibles und funktionales büro system bietet umfassende Nutzungsmöglichkeiten und passt sich harmonisch in den Arbeitsbereich ein. *Landscape* wurde mithilfe moderner Technologien und komplexer industrieller Verarbeitungen hergestellt und erfüllt konkret die unterschiedlichen Ansprüche der Welt des Büros. Es setzt sich aus unterschiedlichen Elementen zusammen und bietet Tische, Arbeitsplätze und Schubladen module auf rollen, die sich durch weiche Linien und elegante Volumen auszeichnen.

*Landscape*, a highly flexible and functional office furniture system that blends harmoniously into the working environment while ensuring maximum versatility of use. Produced by means of advanced technologies and complex manufacturing processes, *landscape* provides concrete answers to the diversified needs of the office world: it offers a wide choice of elements, including tables, workstations and drawer, all of them characterised by soft lines and highly refined volumes.

*Landscape*, un système pour bureau flexible et fonctionnel offrant une vaste possibilité d'utilisation en s'intégrant harmonieusement dans les milieux de travail. Réalisé au moyen de technologies avancées et d'usinages industriels complexes, *landscape* répond concrètement aux différentes requêtes de l'univers bureau, en se déclinant en différents éléments tels que des tables, des postes de travail et des chariots caractérisés par des lignes douces et des volumes raffinés.

# LANDSCAPE



LANDSCAPE SYSTEM



LANDSCAPE MEETING

L'offerta di *landscape* si organizza attraverso 2 tipologie principali adatte a contesti d'uso differente: *meeting*, ideale per sale riunioni, è proposto in tre dimensioni (cm 158x316, cm 158x400 e cm 120x316) e nella versione più sofisticata è totalmente impiallacciato in essenza. *System*, ideale per realizzare postazioni di lavoro multiple.

The *landscape* system is comprised of 2 main types, suitable for different utilisation conditions: *meeting*, the ideal table for meeting rooms, comes in three sizes (158x316 cm, 158x400 cm and 120x316 cm) and in its most refined versions it is fully veneered with wood; *system*, the ideal choice to set up multiple work station.

*Landscape* ist in 2 Haupttypologien für unterschiedliche Nutzungsbereiche erhältlich: *meeting* ist ideal für Konferenzräume und ist in drei Größen erhältlich (cm 158x316, cm 158x400 und cm 120x316) sowie in der elegantesten Ausführung in Holzfurnier; *System* ist ideal für Mehrfach-Arbeitsplätze.

L'offre de *landscape* se décline en 2 typologies principales, pensées pour des utilisations différentes: *meeting*, idéale pour les salles de réunion, est proposée en trois dimensions (cm 158x316, cm 158x400 et cm 120x316) ainsi que dans une version plus sophistiquée, entièrement plaquée en bois; *system*, parfaite pour réaliser des postes de travail multiples.



# OVERVIEW

**Dividing panels / Pannelli divisori**  
 (only for Landscape system / solo per Landscape system)  
 They are placed on the table through a slot in the table top.  
*S'inseriscono sul tavolo attraverso un pratico alloggiamento nel piano del tavolo.*



**Top / Piano**  
 The Landscape offer is organised through different types suitable for different uses.  
*L'offerta Landscape si organizza attraverso diverse tipologie adatte ad usi differenti.*



## Landscape system / Landscape meeting

oak veneered MDF / MDF impiallacciato rovere

NOTA:  
 Landscape meeting does not have slots for partition panels.  
*Landscape meeting non prevede la predisposizione per pannelli divisori.*

**LS1** cm 158x158 - h. cm 74  
**LS1** cm 200x158 - h. cm 74  
**LS2** cm 316x158 - h. cm 74  
**LS2** cm 400x158 - h. cm 74

**LM1** cm 316x120 - h. cm 74  
**LM2** cm 316x158 - h. cm 74  
**LM2** cm 400x158 - h. cm 74



**Structure (legs and frame) / Struttura**  
 in lacquered aluminium or oak veneered aluminium  
*in alluminio verniciato o impiallacciata rovere*



**Chest of drawer / Cassettiera**  
 with wheels made in lacquered plastic with drawer  
 in lacquered or oak veneered MDF  
*con ruote realizzata in poliuretano compatto verniciato  
 con un cassetto in MDF laccato o impiallacciato.*

## \*Central leg positioning / Posizionamento gamba centrale

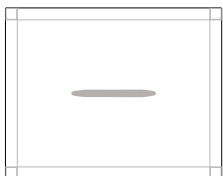

LS1\_Landscape system  
 158x158/200 cm

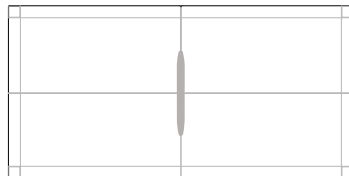

LS2\_Landscape system  
 158x316 cm

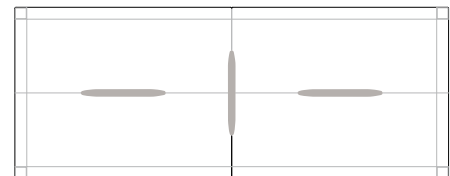

LS2\_Landscape system  
 158x400 cm





**Cover for dividing panels / Cover pannelli divisori**  
 (only for Landscape system / solo per Landscapae system)  
 in Camira® or Kvadrat® fabrics  
 in tessuto Camira® o Kvadrat®

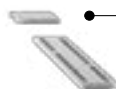

**Cable lid / Coperchio**  
 in oak veneered plywood or full color  
 in multistrato impiallacciato rovere o full color



## Landscape system

Fenix-NTM® laminate MDF / MDF bilaminato Fenix-NTM®

- LS1 cm 158x158 - h. cm 74
- LS1 cm 200x158 - h. cm 74
- LS2 cm 316x158 - h. cm 74
- LS2 cm 400x158 - h. cm 74

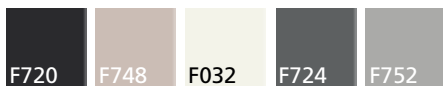

**Top's details / Dettagli piano**  
 oak veneered / Fenix-NTM® laminate  
 impiallacciato rovere / Fenix-NTM®

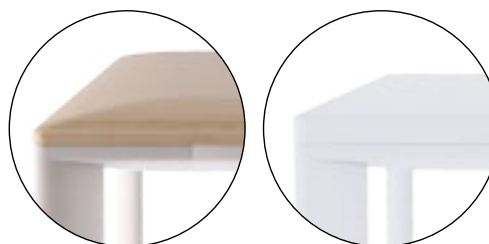

**Cable tray / Reggicavi**



**Central leg / Gamba centrale\***  
 depending on the size of the top one or more  
 central lacquered legs are provided.  
 Each leg has adjustable feet.  
 A seconda delle dimensioni del piano è  
 prevista una o più gambe centrali verniciate.  
 Ogni gamba prevede piedini regolabili.



LM1\_Landscape meeting  
 120x316 cm

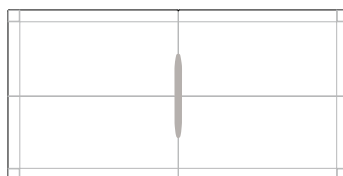

LM2\_Landscape meeting  
 158x316 cm

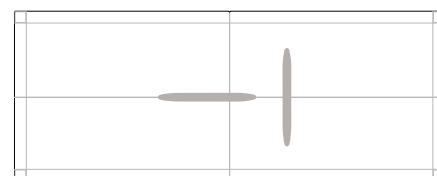

LM2\_Landscape meeting  
 158x400 cm

# DIMENSIONS

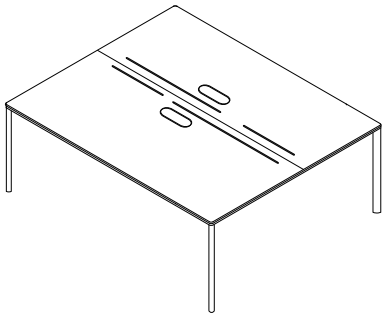

LANDSCAPE SYSTEM / LS1

cm 158x158 - h cm 74  
cm 200x158 - h cm 74

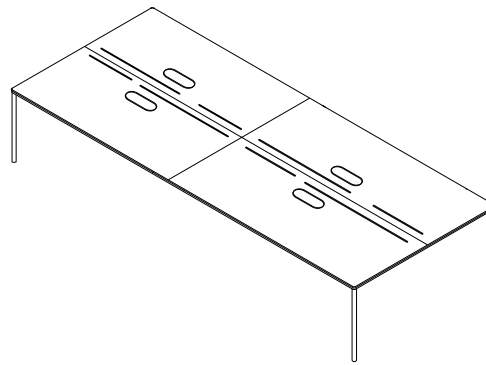

LANDSCAPE SYSTEM / LS2

cm 316x158 - h cm 74  
cm 400x158 - h cm 74

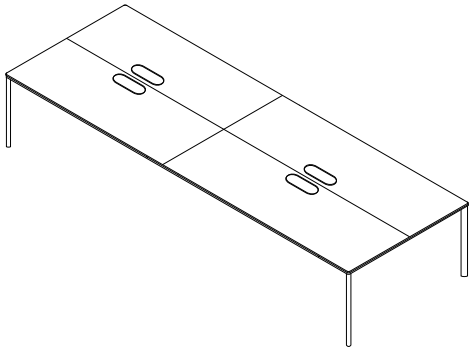

LANDSCAPE MEETING / LM1 - LM2

cm 316x120 - h cm 74  
cm 316x158 - h cm 74  
cm 400x158 - h cm 74

## ACCESSORIES

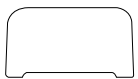

SMALL PANEL (cover optionals)

cm 55 - h cm 30

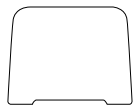

MEDIUM PANEL (cover optionals)

cm 47 - h cm 60



LARGE PANEL (cover optionals)

cm 97 - h cm 35

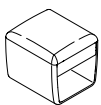

DRAWER / LA3

cm 42x45 - h cm 45

# FINISHES

## STRUTTURA / STRUCTURE / GESTELL / STRUCTURE

Alluminio verniciato gofrato  
Textured lacquered aluminium  
Lackiertes gerauhtes Aluminium  
Aluminium laqué granité

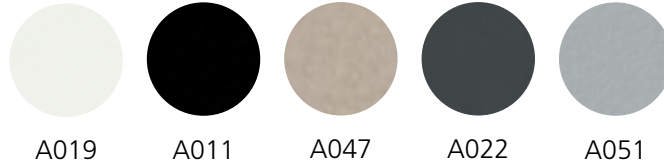

Impiallacciato  
Veneered  
Furnierung  
Plaqué

Rovere naturale  
Natural oak  
Eiche natur  
Chêne naturel

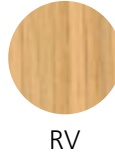

Rovere grigio cenere  
Ash grey oak  
Eiche aschgrau  
Chêne gris cendré



## PIANO / TOP / TISCHPLATTE / PLATEAU

Fenix-NTM®  
Fenix-NTM®  
Fenix-NTM®  
Fenix-NTM®

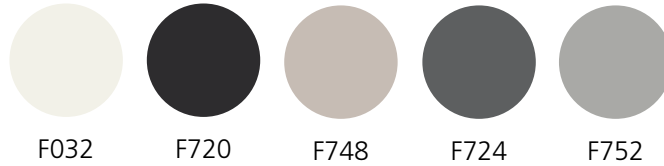

Impiallacciato  
Veneered  
Furnierung  
Plaqué

Rovere naturale  
Natural oak  
Eiche natur  
Chêne naturel

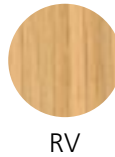

Rovere grigio cenere  
Ash grey oak  
Eiche aschgrau  
Chêne gris cendré

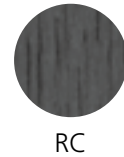

## ACCESSORIES

MDF laccato  
lacquered MDF  
MDF Lackiert  
MDF laqué

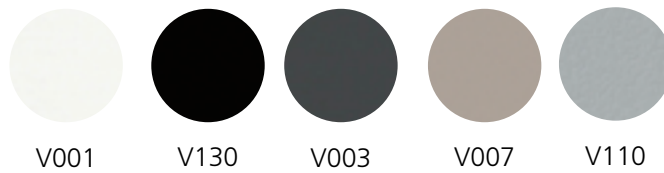

Materiale plastico verniciato  
Plastic material lacquered  
Lackiertes Kunststoffmaterial  
Matériau plastique laqué



Tessuto  
Fabric  
Stoff  
Tissu

**Camira® A**  
Xtreme  
Urban

**Kvadrat® B**  
Maple  
Remix  
Tonus

**Kvadrat® C**  
Canvas  
Divina  
Foss  
Hallingdal 65  
Hero  
Steelcut  
Steelcut trio



# MANZÙ TABLE

PIO MANZÙ



Rispettando la filosofia del prodotto originale, Alias sviluppa un tavolo a gamba centrale composto da due elementi: la struttura in poliuretano compatto, verniciato in diversi colori, e il piano con il cerchio centrale, proposto in alluminio anodizzato o in marmo che ruota rispetto alla corona realizzata in MDF verniciato, assolvendo diverse funzioni in linea con il vivere contemporaneo.

Zusammenhängend der Philosophie des Originalprodukts entwickelt Alias einen Tisch mit einem zentralen Bein, der aus zwei Elementen besteht: Das Gestell besteht aus kompaktem Polyurethan lackiert in verschiedenen Farben und die Platte aus lackiertem MDF hat einen zentralen Kreis aus eloxiertem Aluminium oder Marmor, der sich im Verhältnis zum Kranz dreht und erfüllt verschiedene Funktionen im Einklang mit dem zeitgenössischen Wohnen.

Following the philosophy of the original product, Alias develops a table composed of two elements with a central leg: the frame is made of compact polyurethane lacquered in different colours and the top in lacquered MDF has a central circle, available in anodised aluminium or marble, that rotates in relation to the external ring, fulfilling different functions in line with contemporary living.

Respectant la philosophie du produit original, Alias développe une table avec un pied central composé de deux éléments: la structure en polyuréthane compact laqué en différentes couleurs, et le plateau avec le cercle central proposé en aluminium anodisé ou en marbre qui tourne par rapport à la couronne réalisée en MDF laqué, en se prêtant à différentes utilisations conformément au style de vie contemporaine.

## MANZÙ TABLE



L'attenzione di Alias si focalizza su un tavolo disegnato da Pio Manzù per casa Agnelli a Roma caratterizzato da una base dal segno scultoreo che sostiene un piano circolare, dove la parte centrale ruota rispetto alla corona esterna dei posti-tavola. Il tavolo rispecchia la capacità dello storico marchio di design nel selezionare un oggetto del passato di grande carica innovativa e trasferirlo nel mondo contemporaneo con degli accorgimenti che lo rendono estremamente attuale.

Alias' attention focuses on a table designed by Pio Manzù for Casa Agnelli in Rome, characterised by a sculptural base that supports a circular top, where the central part rotates in relation to the outer crown of the table seats. The table reflects the historic design brand's ability to select an object from the past with great innovative power and transfer it to the contemporary world with such adaptations that make it extremely contemporary.

Die Aufmerksamkeit von Alias richtet sich auf einen von Pio Manzù für die Casa Agnelli in Rom entworfenen Tisch. Er zeichnet sich durch ein skulpturales Gestell aus, der eine kreisförmige Platte trägt, deren mittlerer Teil sich im Verhältnis zum äußeren Kranz des Tisches dreht. Der Tisch spiegelt die Fähigkeit der historischen Designmarke wider, ein Objekt aus der Vergangenheit mit großer Innovationskraft auszuwählen und es in die heutige Welt zu übertragen, mit einem Touch, der es äußerst zeitgemäß macht.

L'attention d'Alias se concentre sur une table dessinée par Pio Manzù pour la maison Agnelli à Rome caractérisée par une base au signe sculptural qui soutient un plateau circulaire, où la partie centrale tourne par rapport à la couronne extérieure des sièges-table. La table reflète la capacité de la marque historique du design à sélectionner un objet du passé de grande charge innovante et à le transférer dans le monde contemporain avec des précautions qui le rendent extrêmement actuel.

## DIMENSIONS

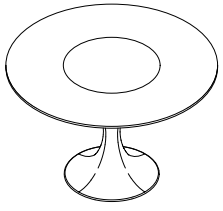

MANZÙ TABLE / 08A

Ø cm 140 - h cm 72

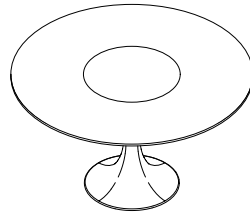

MANZÙ TABLE / 08B

Ø cm 160 - h cm 72

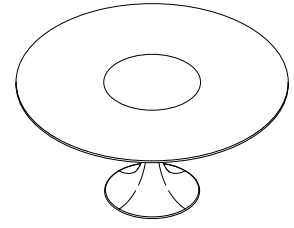

MANZÙ TABLE / 08C

Ø cm 180 - h cm 72

## FINISHES

### BASE / BASE / BASIS / BASE

Materiale plastico verniciato  
Plastic material lacquered  
Lakiertes Kunststoffmaterial  
Matériau plastique laqué

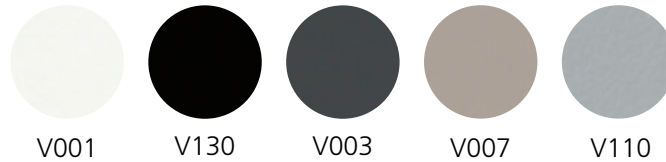

V001

V130

V003

V007

V110

### PIANO / TOP / TISCHPLATTE / PLATEAU

MDF laccato  
Lacquered MDF  
MDF Lackiert  
MDF laqué

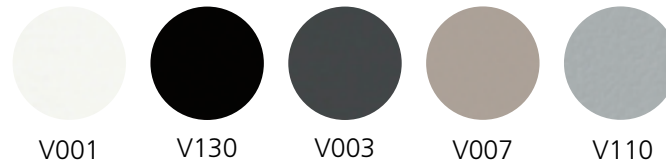

V001

V130

V003

V007

V110

### PIATTO CENTRALE / CENTRAL PLATE / ZENTRALER PLATTE / PLATEAU CENTRAL

Alluminio anodizzato  
Aluminium Anodized  
Aluminium Eloxiert  
Aluminium anodisé



AS

Alluminio verniciato  
Lacquered aluminium  
Aluminium lackiert  
Aluminium laqué



V001

V130

V003

V007

V110

Marmo bianco di Carrara  
Marble bianco Carrara  
Marmor bianco Carrara  
Marbre bianco Carrara



MA01





# PLETTO

PAOLO RIZZATTO



In un momento di forte trasformazione della fruizione degli spazi domestici, attraverso la collezione *pletto*, Alias affronta assieme a Paolo Rizzatto un tema della tradizione che diventa contemporaneo grazie ad un lavoro di analisi attento, riuscendo ad innovare dal punto di vista tipologico e formale un prodotto come il tavolo domestico con cassetto.

In einer Zeit, in der sich die Nutzung der häuslichen Räume stark verändert, greift Alias mit der Kollektion *pletto* ein traditionelles Thema auf, das dank einer sorgfältigen Analyse zeitgemäß wird, und schafft es, ein Produkt wie den Wohnzimmer-Schubladentisch in typologischer und formaler Hinsicht zu erneuern.

In a moment of strong transformation of the fruition of the domestic spaces, through the *pletto* collection, Alias faces together with Paolo Rizzatto a theme of tradition that becomes contemporary thanks to a process of careful analysis, succeeding in innovating a product like the domestic table with drawer from the typological and formal point of view.

Dans une période de grande transformation de l'utilisation des espaces domestiques, Alias, à travers la collection *pletto*, aborde avec Paolo Rizzatto un thème traditionnel qui devient contemporain grâce à une analyse attentive, et parvient à innover d'un point de vue typologique et formel un produit comme la table domestique avec tiroir.

## PLETTRO



PLETTRO



PLETTRO DESK

*Plettro* è caratterizzato da un piano scomposto che diventa una struttura a trave molto rigida, formata da due top sottili intersecati da una serie di elementi in legno che dividono spazi e nei quali scorrono i cassetti. Sul piano dei modelli pensati per l'home office trova posto un efficace sistema di cable management.

*Plettro* is characterised by a decomposed top that becomes a very rigid beam structure, formed by two thin tops intersected by a series of wooden elements that divide spaces and in which the drawers slide. The tops of the home office tables are provided with a cable management system.

*Plettro* zeichnet sich durch eine zerlegte Platte aus, die zu einer sehr starren Balkenstruktur wird. Diese besteht aus zwei dünnen Platten, die von einer Reihe von Holzelementen gekreuzt werden, die den Raum unterteilen und in denen die Schubladen gleiten. Die Platte, des für das Home-Office konzipierten Tisches, sind mit einem Kabelmanagement ausgestattet.

*Plettro* se caractérise par un plateau décomposé qui devient une structure à poutre très rigide, formée par deux fins plateaux entrecoupés par une série d'éléments en bois qui divisent les espaces traversés par les tiroirs. Les modèles conçus pour les bureaux à la maison présentent un système efficace de rangement des fils et des câbles.

# PLETTRO



PLETTRO W04



PLETTRO W03



PLETTRO W05

# DIMENSIONS

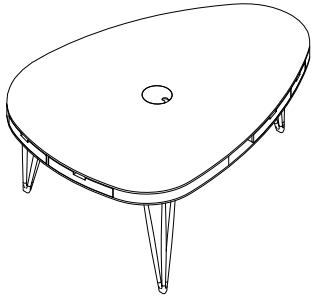

PLETTRO / W02

200x150 - h cm 78

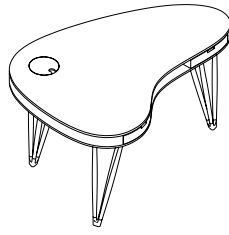

PLETTRO DESK / W01

145x105 - h cm 78

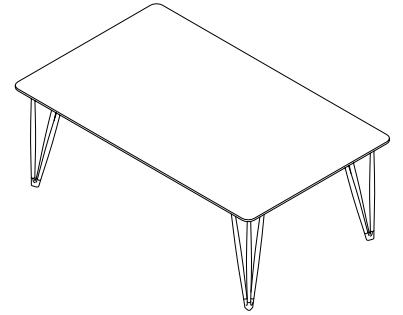

PLETTRO 200x120 / W03\_200

200x120 - h cm 72

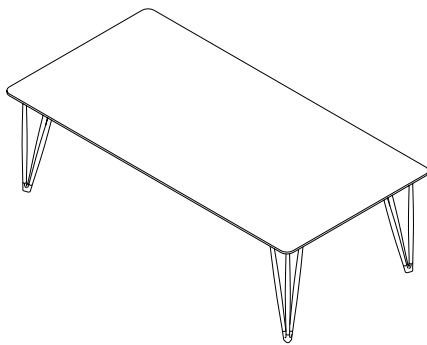

PLETTRO 240x120 / W03\_240

240x120 - h cm 72

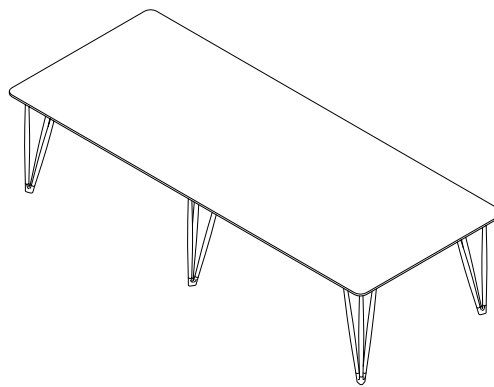

PLETTRO 300x120 / W03\_300

300x120 - h cm 72

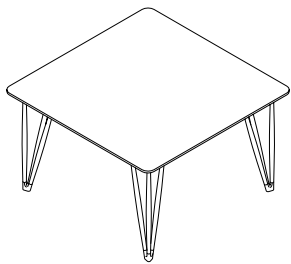

PLETTRO 120x120 / W04\_120

120x120 - h cm 72

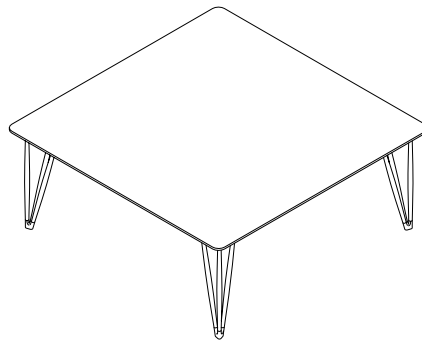

PLETTRO 180x180 / W04\_180

180x180 - h cm 72



PLETTRO Ø120 / W05\_120

Ø cm 120 - h cm 72

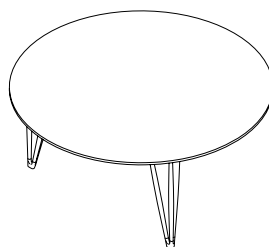

PLETTRO Ø160 / W05\_160

Ø cm 160 - h cm 72

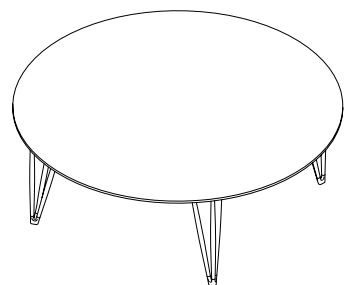

PLETTRO Ø200 / W05\_200

Ø cm 200 - h cm 72

## FINISHES

Legno  
Wood  
Holz  
Bois

Rovere naturale  
Natural oak  
Eiche natur  
Chêne naturel



RV

Rovere sbiancato  
Whitened oak  
Eiche gebleicht  
Chêne blanchi



RVS

Rovere grigio cenere  
Ash grey oak  
Eiche aschgrau  
Chêne gris cendré



RC

Acero naturale  
Natural maple  
Ahorn natur  
Erable naturel



ACN

Rovere noce canaletto  
Canaletto walnut oak  
Eiche canaletto nußbaum  
Chêne noyer canaletto



NCT

Coloured stains  
Verniciatura a poro aperto  
Offenporig lackiert  
Laquage à pore ouvert



V140

### GIUNTI / CONNECTING ELEMENTS / VERBINDUNGSELEMENTE / JOINTS

Alluminio verniciato goffrato  
Textured lacquered aluminium  
Lackiertes gerauhtes Aluminium  
Aluminium laqué granité



A019

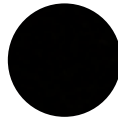

A011



A047



A022



A051

Alluminio verniciato metallizzato  
Metallic lacquered aluminium  
Aluminium metallic Lackiert  
Aluminium laqué métallisé



A048



A049



A050



# SAEN

GABRIELE & OSCAR BURATTI



Gabriele e Oscar Buratti interpretano per Alias la tipologia del tavolo a base centrale, fondendo l'eleganza del disegno alla ricercatezza materica. Nasce così *saen*, una famiglia di tavoli caratterizzata da una base importante che in un disegno fluido, continuo e morbido, diventa stelo esile e slanciato, in un contrasto formale molto forte.

Gabriele und Oscar Buratti interpretieren für Alias den Tisch mit zentraler Basis und kombinieren elegantes Design und ausgesuchtes Material. So entsteht *saen*, eine Tischfamilie mit ausladender Basis welche mittels einem flüssigen, durchgehenden, weichen Design in einem feinen, schlanken Schaft endet.

Gabriele and Oscar Buratti portray for Alias the table with a central leg, combining the elegance of the design with sophisticated materials. The result is *saen*, a table family with an imposing base. Its fluid, continuous and soft design sees this table turned into a slender, willowy stem, creating a powerful contrast of shapes.

Gabriele et Oscar Buratti créent pour Alias une table à piètement central qui mêle l'élégance du design à la recherche de la matière. Voici *saen*, une famille de tables caractérisée par un piètement imposant qui, par son design fluide, souple et continu, se transforme en une tige fine et élancée qui crée un vif contraste.

## SAEN



SAEN



SAEN OUTDOOR



SAEN XS



SAEN XS OUTDOOR

La base è realizzata in poliuretano rigido compatto, un materiale dalle elevate prestazioni, ad alto contenuto tecnico ed estetico. Questo tecnopolimero, infatti, consente di ottenere una superficie uniforme e pulitissima, preservando la sagoma in cemento del progetto originario. Allo stelo rifinito con vernici goffrate vengono fissati piani di forme diverse, in mdf o legno laccato in varie finiture

The base is made of compact rigid polyurethane, a high performance material with advanced technical and aesthetic properties. This technopolymer, in fact, makes it possible to obtain a perfectly clean and even surface, preserving the concrete silhouette of the original project. Onto the stem, finished with textured paint, are rested tops in different shapes in MDF or lacquered wood in various finishes.

Die Basis besteht aus kompaktem, festem, leistungsfähigem Polyurethan mit hohen technischen und ästhetischen Eigenschaften. Dieses Technopolymer erlaubt die Schaffung einer einheitlichen, sehr reinen Oberfläche und bewahrt die aus Zement bestehende Form des Ursprungsprojekts. An dem mit gerauhten Lack verarbeiteten Stiel werden Tischplatten in unterschiedlichen Formen fixiert, aus MDF oder aus in verschiedenen Farben lackiertem Holz.

La base est réalisée en polyuréthane rigide compact, un matériau hautement performant sur le plan technique et esthétique. Ce technopolymère permet en effet d'obtenir une surface uniforme et très épurée, en préservant la silhouette en béton du projet d'origine. Les plateaux, de forme différente, en mdf ou bois laqué dans divers coloris, sont fixés à la tige, traitée avec des peintures gaufrées.



## DIMENSIONS

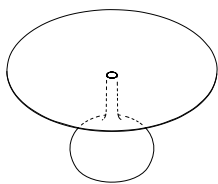

SAEN / 011

Ø cm 140/160/180 - h cm 74.5 - base Ø 49 cm

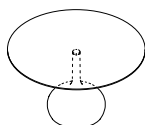

SAEN XS / SN6

Ø cm 50/60/70 - h cm 50 - base Ø 35 cm

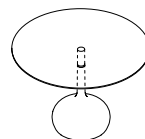

SAEN XS / SN6

Ø cm 50/60/70 - h cm 63 - base Ø 35 cm

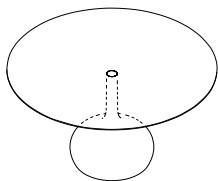

SAEN OUTDOOR / 012\_O

Ø cm 150 - h cm 74.5 - base Ø 49 cm

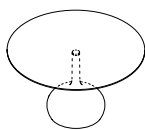

SAEN XS OUTDOOR / SN5\_O

Ø cm 50/60 - h cm 50 - base Ø 35 cm

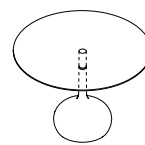

SAEN XS OUTDOOR / SN5\_O

Ø cm 50/60 - h cm 63 - base Ø 35 cm

## FINISHES

BASE / BASE / BASIS / BASE

\* Poliuretano verniciato  
Lacquered polyurethane  
Lackiertes Polyurethan  
Polyuréthane laqué

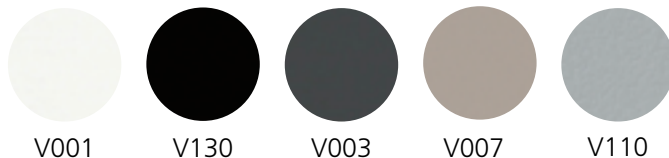

V001

V130

V003

V007

V110

PIANO / TOP / TISCHPLATTE / PLATEAU

MDF laccato  
lacquered MDF  
MDF Lackiert  
MDF laqué



V001

V130

V003

V007

V110

Ceramica smaltata  
Glazed ceramic  
Glasierter Keramik  
Céramique émaillée



V001

V130

V003

V007

\* AVAILABLE FOR OUTDOOR  
FINISHES ONLY FOR OUTDOOR



# TEC / TEC SYSTEM

ALFREDO HÄBERLI



*TEC* è un tavolo componibile con gambe in fusione di alluminio dal design slanciato che si agganciano a una struttura in alluminio estruso arretrata rispetto al bordo del tavolo offrendo la percezione di un piano in volo. Questa soluzione permette alla struttura di supportare anche top molto lunghi garantendo una gamma di tavoli infinita.

*TEC* ist ein modularer Tisch mit schlanken Beinen aus Aluminiumdruckguss welche an einer Struktur aus Strangpressaluminium fixiert sind, die im Vergleich zum Tischrand etwas zurückversetzt ist. Dadurch wird der Eindruck vermittelt, das die Tischplatte schwebt. Diese Lösung ermöglicht auf dem Gestell die Anbringung sehr langer Tischflächen und somit eine unbegrenzte Produktpalette in verschiedenen Größen.

*TEC* is a modular table featuring slender legs in die-cast aluminium connected onto an extruded aluminium structure set back relative to the edge of the table top to achieve an interesting visual effect as the top seems to be floating in the air. This configuration supports extremely long tops thereby making it possible to choose from a very broad range of sizes.

*TEC* est une table composable avec piètement en aluminium moulé sous pression au design élancé, se fixant à une structure en aluminium extrudé en retrait par rapport au chant de la table en donnant l'illusion d'un plateau en suspension. Cette solution permet à la structure de soutenir des plateaux très longs et garantit une gamme très vaste de dimensions.

## TEC



TEC 800 / 630



TEC 1000 / 632

La finitura del bordo del tavolo *TEC* presenta diverse sezioni a seconda del materiale impiegato: si va dal sottilissimo piano in full color, al piano in rovere.

The finish of the *TEC* table top edge can have different sections depending on the material used: from an extremely thin full color top, to that in oak version.

Die Ausführung der *TEC*-Tischkante hat unterschiedliche Querschnitte je nach verwendetem Material: von der super dünnen Tischplatte aus Full Color bis zur Tischplatte aus Eiche.

La finition du bord de la table *TEC* présente différentes sections en fonction du matériau utilisé : elle va du plateau très fin en full color au plateau en chêne blanchi.

## INTERIOR SOLUTIONS



**TEC**  
FINISHES: TEXTURED LACQUERED ALUMINIUM (A019) BILAMINATE (BBCO)  
**MEETINGFRAME 44**  
FINISHES: TEXTURED LACQUERED ALUMINIUM (A019) MESH B (R003)



**TEC CABLE**  
FINISHES: TEXTURED LACQUERED ALUMINIUM (A019) FULL COLOR (FC01) FABRIC KVADRAT®  
**ROLLINGFRAME + TILT 47**  
FINISHES: TEXTURED LACQUERED ALUMINIUM (A011) MESH A (R007)  
**SEC**  
FINISHES: TEXTURED LACQUERED ALUMINIUM/STEEL (A019)

# TEC

## Top

available in:

- Full Color, th. 12 mm
- bilaminate, th. 18 mm
- oak veneered plywood, th. 12 mm

## Piano

disponibile in:

- Full Color sp. 12 mm
- bilaminato sp. 18 mm
- multistrato impiallacciato rovere sp. 12 mm



## Structure

in lacquered or polished die-cast and extruded aluminium elements

## Struttura

composta da fusioni ed estrusi di alluminio verniciati o lucidati.

## Top finishes Finiture Piano



## Structure finishes Finiture Struttura

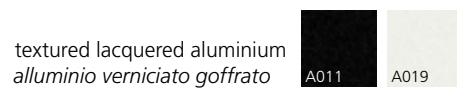
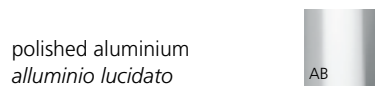

# TEC CABLE / 641

## Dividing panels

available in:

- plywood white Full Color
- MDF covered with Kvadrat® fabric

## Pannelli divisori

disponibile in:

- stratificato Full Color bianco
- MDF rivestito con tessuto Kvadrat®

## Cable lid Passacavi

**Top**  
available in plywood white  
Full Color, th. 12 mm

**Piano**  
disponibile in stratificato  
Full Color bianco

**Cable tray + support for dividing panel**  
in white lacquered steel

**Contenitore per cavi + supporto  
per pannello divisorio**  
in acciaio verniciato bianco

**Cable cover**  
in plastic material to group the cables

**Vertebra**  
in materiale plastico  
che offre il supporto per raggruppare i cavi

**Structure**  
in white lacquered or polished  
die-cast and extruded aluminium  
elements

**Struttura**  
composta da fusioni ed estrusi di  
alluminio verniciati o lucidati

## Top finishes Finiture Piano

Full Color

FC01

## Structure finishes Finiture Struttura

polished aluminium  
alluminio lucidato

AB

alluminio verniciato gofrato  
textured lacquered aluminium

A019

## TEC SYSTEM

### TEC System panel (642)

Dividing panel available in:  
 - plywood white Full Color  
 - MDF covered with Kvadrat® fabric

In the following dimensions:  
 cm 117 x h cm 35  
 cm 157 x h cm 35

### TEC SYSTEM PANEL (642)

Pannelli divisori disponibili in:  
 - stratificato Full Color bianco  
 - MDF rivestito con tessuto Kvadrat®

Nelle seguenti dimensioni:  
 cm 117 x h cm 35  
 cm 157 x h cm 35

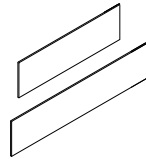

**TEC** is also a table **system** thanks to the addition of a leg, which allows to configure three new modules and placed side by side create various configurations: the initial 4-leg module, the central modules, and the end 2-leg module.

**TEC** diventa un **sistema** grazie all'introduzione di una gamba che consente di configurare tre moduli, che accostati tra loro permettono di creare diverse configurazioni: il modulo iniziale a 4 gambe, i moduli centrali e il modulo finale a 2 gambe.

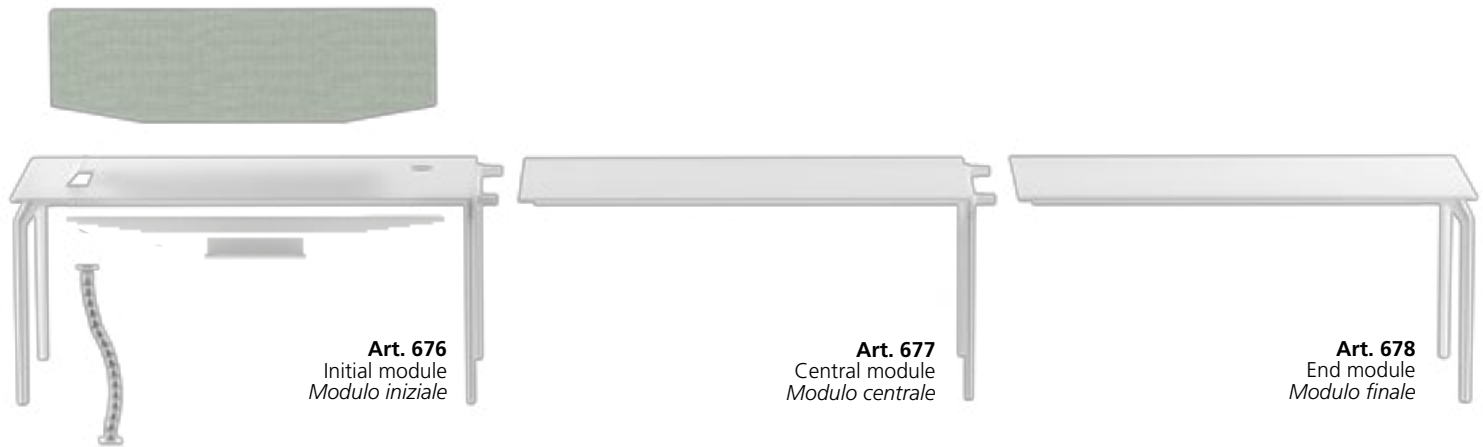

**Art. 676**  
Initial module  
Modulo iniziale

**Art. 677**  
Central module  
Modulo centrale

**Art. 678**  
End module  
Modulo finale

## TEC SYSTEM 800

**676** 160-200 x 80 h. 73,5 cm

**677** 160-200 x 80 h. 73,5 cm

**678** 160-200 x 80 h. 73,5 cm

### Dividing panel finishes Finiture Pannello divisorio

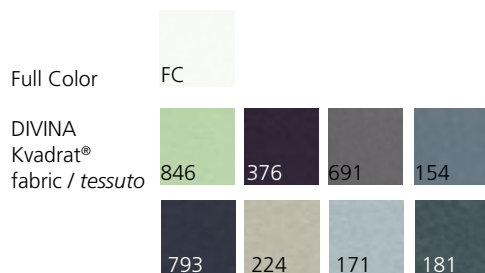

### Top finishes Finiture Piano



### Structure finishes Finiture Struttura

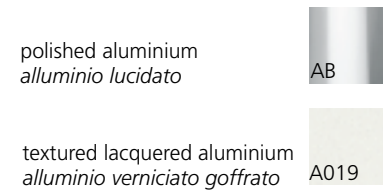



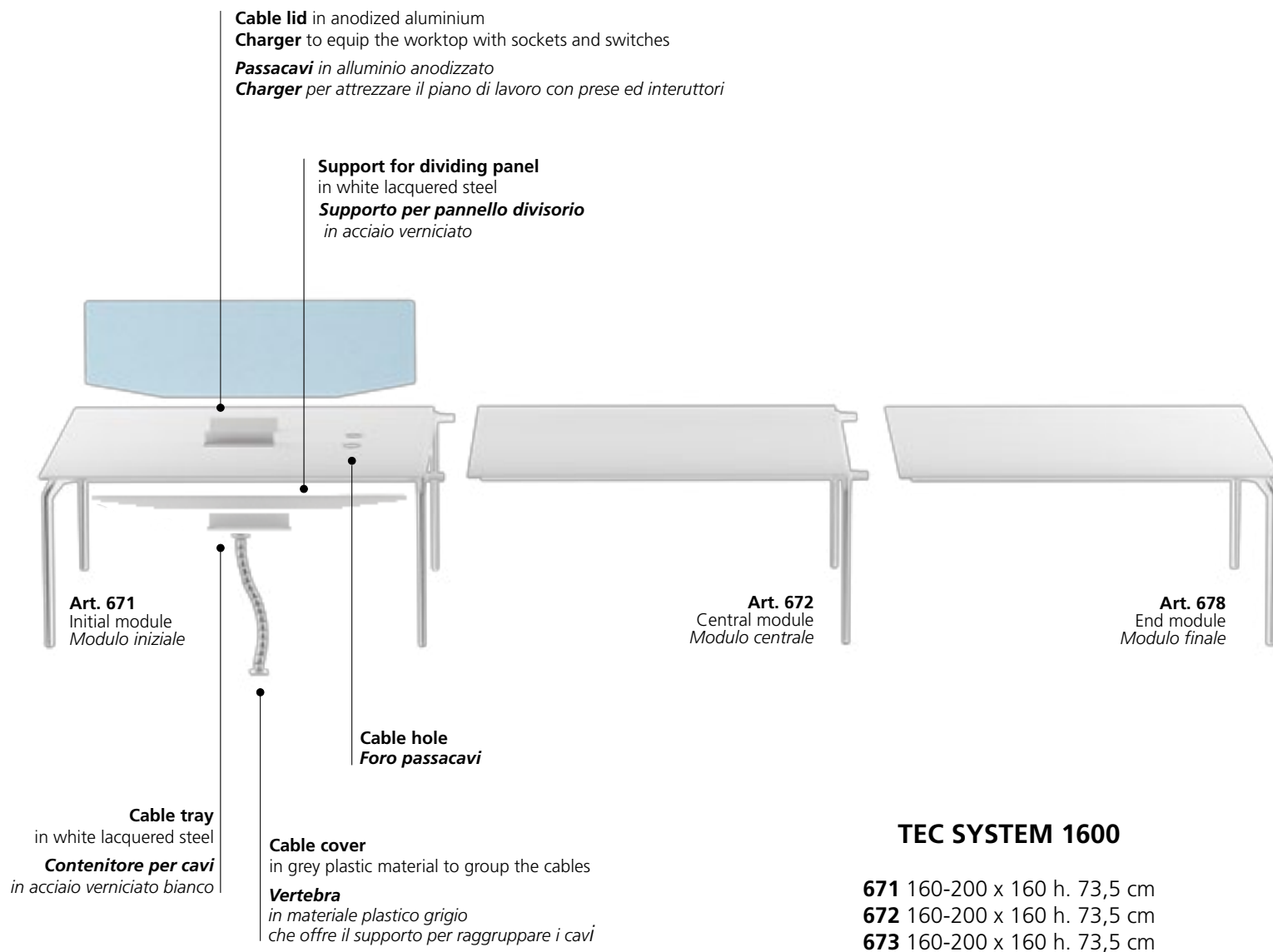

**TEC System configuration examples**  
**Esempi di configurazioni Tec System**

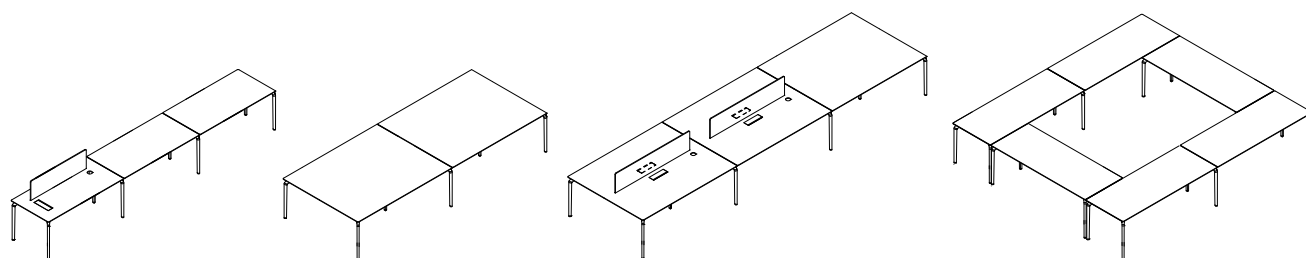

# DIMENSIONS

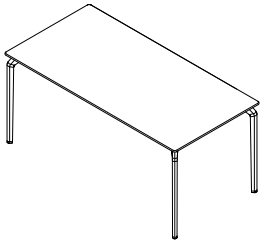

**TEC 800 / 630**

cm 200x80 - h cm 73,5  
cm 160x80 - h cm 73,5

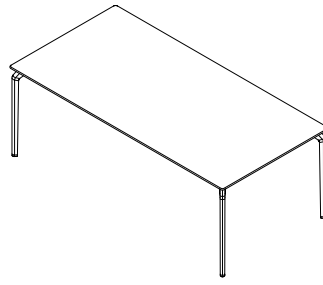

**TEC 1000 / 632**

cm 200x100 - h cm 73,5  
cm 240x100 - h cm 73,5

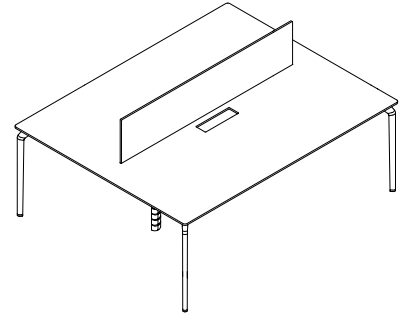

**TEC cable / 641**

cm 160x160 - h cm 73,5  
cm 200x160 - h cm 73,5

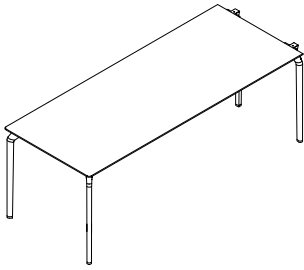

**TEC SYSTEM 800 / 676**

cm 160x80 - h cm 73,5  
cm 200x80 - h cm 73,5

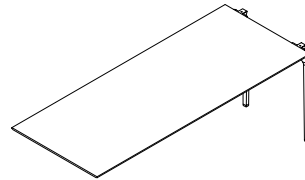

**TEC SYSTEM 800 / 677**

cm 160x80 - h cm 73,5  
cm 200x80 - h cm 73,5

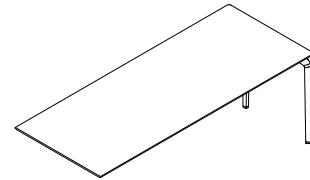

**TEC SYSTEM 800 / 678**

cm 160x80 - h cm 73,5  
cm 200x80 - h cm 73,5

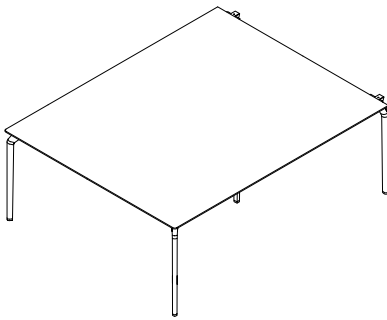

**TEC SYSTEM 1600 / 671**

cm 200x160 - h cm 73,5  
cm 160x160 - h cm 73,5

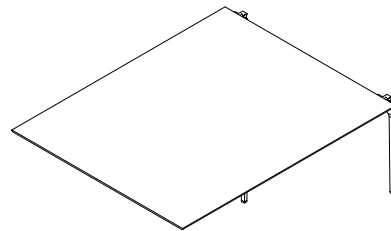

**TEC SYSTEM 1600 / 672**

cm 160x160 - h cm 73,5  
cm 200x160 - h cm 73,5

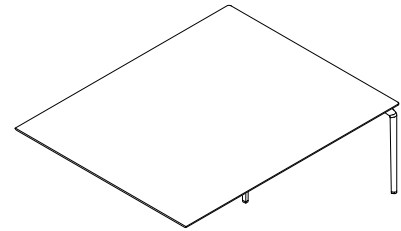

**TEC SYSTEM 1600 / 673**

cm 160x160 - h cm 73,5  
cm 200x160 - h cm 73,5

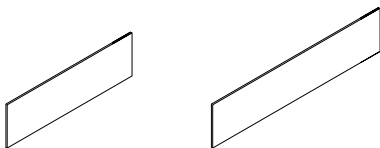

**TEC SYSTEM PANEL / 642**

cm 117x35 / 157x35

# FINISHES

## STRUTTURA / STRUCTURE / GESTELL / STRUCTURE

Alluminio lucidato  
Polished aluminium  
Aluminium poliert  
Aluminium poli



AB

Alluminio verniciato goffrato  
Textured lacquered aluminium  
Lackiertes gerauhtes Aluminium  
Aluminium laqué granité



A019



A011

Not available on  
TEC system and TEC  
cable 641

## PIANO / TOP / TISCHPLATTE / PLATEAU

Full color  
Full color  
Full color  
Full color



FC01



FC04

Not available on  
TEC system and TEC  
cable 641

Bilaminato  
Bilaminate  
Bilaminat  
Bilaminé



BBCO

Finitura non disponibile su TEC System / TEC cable 641  
Finish not available on TEC System / TEC cable 641  
Ausführung nicht verfügbar für TEC System / TEC Cable 641  
Finition pas disponible sur TEC System / TEC Cable 641

Impiallacciato  
Veneered  
Furnierung  
Plaqué

Rovere sbiancato  
Whitened oak  
Eiche gebleicht  
Chêne blanchi



RVS

Rovere scuro  
Dark oak  
Eiche dunkel  
Chêne foncé



RVT

Finiture non disponibili su TEC System  
Finishes not available on TEC System  
Ausführungen nicht verfügbar für TEC System  
Finitions pas disponibles sur TEC System

## PANNELLI / PANELS / PANEELE / PANNEAUX

Tessuto  
Fabric  
Stoff  
Tissu

**Kvadrat® B**  
Divina

Full color  
Full color  
Full color  
Full color



FC01

# LOUNGE

LOUNGE • LOUNGE • LOUNGE

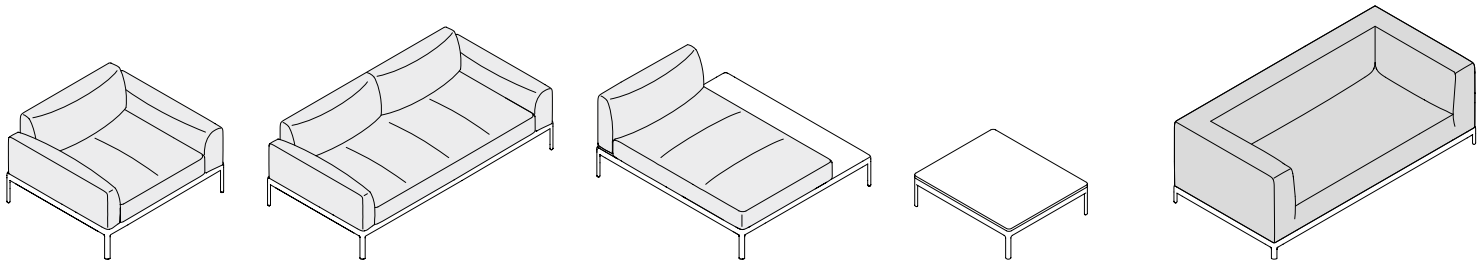

ALUZEN  
pag. 204

ALUZEN SOFT  
pag. 210

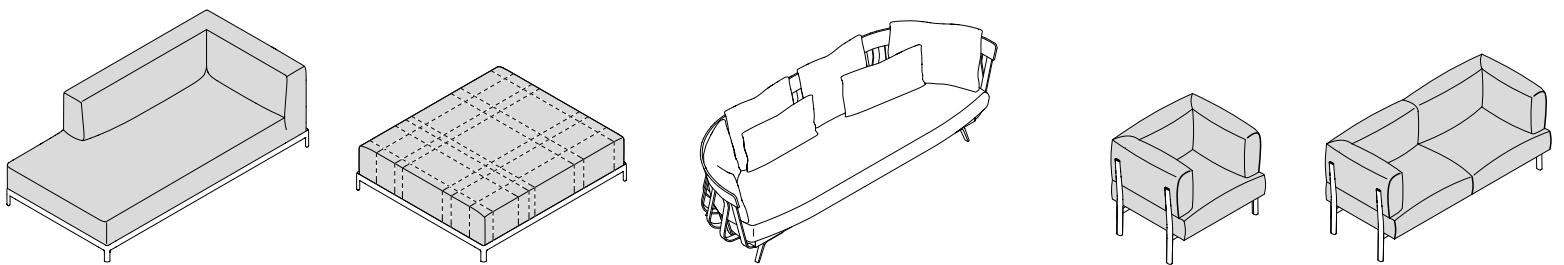

ALUZEN SOFT  
pag. 210

E LA NAVE VA  
pag. 216

ELEVEN  
pag. 222

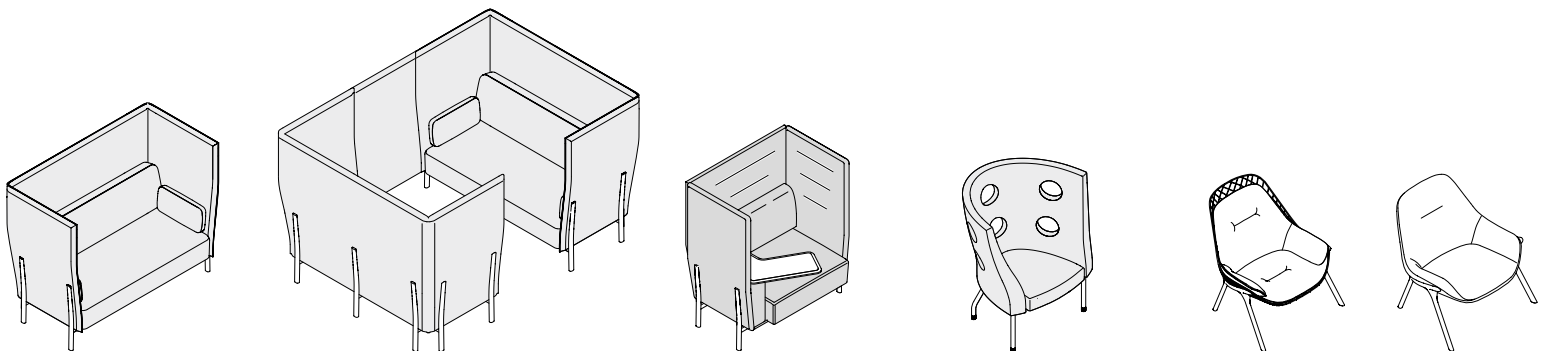

ELEVEN HIGH  
pag. 226

FLEXUS  
pag. 234

GRAN KOBI  
pag. 238

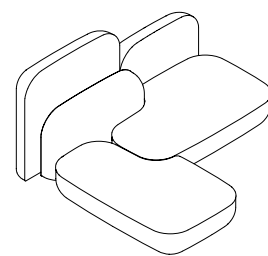
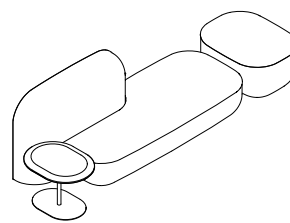
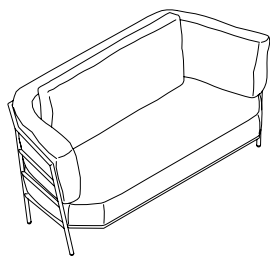
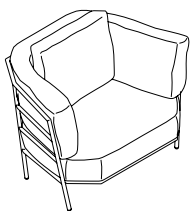

INDOORS  
pag. 242

MANZÙ  
pag. 246

OKOME  
pag. 250

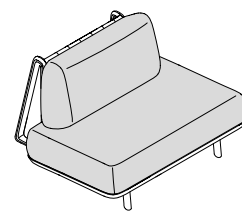
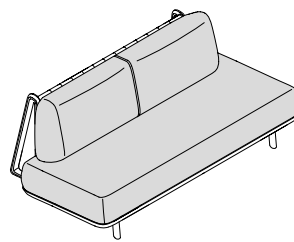
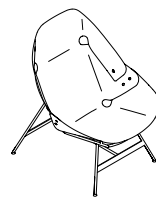
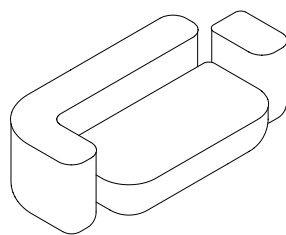
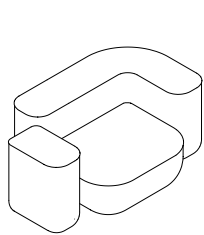

OKOME SOFA  
pag. 256

TIME  
pag. 260

TRIGONO  
pag. 264

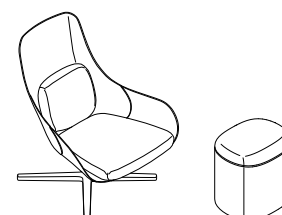
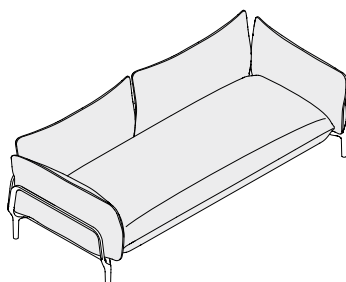
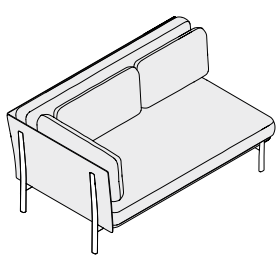
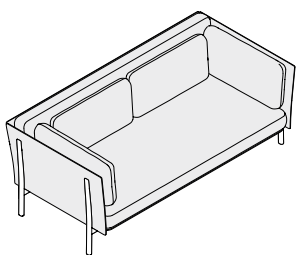

TWELVE  
pag. 268

VINA  
pag. 272

VIOLON  
pag. 276



# ALUZEN

LUDOVICA + ROBERTO PALOMBA



*AluZen*. Un sistema accogliente per pensare, riflettere, meditare. Un progetto autentico, firmato da Ludovica + Roberto Palomba per Alias, che pone al suo centro l'uomo, divenendo una vera e propria isola dove trascorrere i momenti di relax. Pensato per gli ambienti domestici e il mondo dell'hospitality, *AluZen* sorprende per la sua pulizia formale e la tecnicità in linea con il DNA di Alias; un'identità non legata alla tipologia ma alla coerenza progettuale.

*AluZen*. Ein gemütliches System zum Nachdenken und Überlegen. Ein authentisches Projekt entworfen von Ludovica + Roberto Palomba für Alias, das der Mensch im Zentrum stellt und somit eine Insel für Entspannungsmomente wird. *AluZen* wurde für Wohnbereiche und Hotelbetriebe entwickelt: Es überrascht durch seine formale Reinheit und die für Alias typische Technik. Eine Identität, die nicht mit der Typologie, sondern mit der Planungskohärenz in Verbindung steht.

*AluZen*. A comfortable furnishing system designed for thinking, reflecting and meditating. An authentic project designed by Ludovica + Roberto Palomba for Alias, which places people at the centre and becomes a proper island where you can enjoy relaxing moments. Designed for home interiors and hospitality environments, *AluZen* stands out for its formal purity and technicality following Alias DNA: an identity linked to the design consistency, rather than derive from the product type.

*AluZen*. Un système accueillant pour penser, réfléchir, méditer. Un projet authentique, signé pour Alias par Ludovica + Roberto Palomba, qui place l'homme au centre d'une véritable île, idéale pour s'offrir des instants de détente. Pensé pour les espaces domestiques et l'univers de l'accueil, *AluZen* surprend par sa sobriété formelle et sa technicité, en harmonie avec l'ADN d'Alias; une identité non liée à la typologie mais à la cohérence conceptuelle.

# ALUZEN



ALUZEN ENDING 175x95 + ALUZEN MODUL 160x95 + ALUZEN LOW TABLE 80x95



ALUZEN ENDING 175x95



ALUZEN ENDING 175x95 + ALUZEN DORMEUS 175x95



ALUZEN LOW TABLE 80x95



ALUZEN BENCH 160x95 + ALUZEN LOW TABLE Ø30



ALUZEN POUF 80x95 A



Discover other AluZen configuration examples on [alias.design](https://www.alias.design)  
Scopri altri esempi di configurazione AluZen su [alias.design](https://www.alias.design)



## INTERIOR SOLUTIONS



**ALUZEN**

FINISHES: TEXTURED LACQUERED ALUMINIUM (A011) FABRIC ALIAS® LIVING I

**ALUZEN LOW TABLE**

FINISHES: TEXTURED LACQUERED ALUMINIUM (A011) MARBLE BIANCO DI CARRARA (MA01)

**SAEN XS**

FINISHES: POLYURETHANE LACQUERED (V130) FULL COLOR LACQUERED (A011)



**ALUZEN**

FINISHES: TEXTURED LACQUERED ALUMINIUM (A011) FABRIC KVADRAT®

**ALUZEN LOW TABLE**

FINISHES: TEXTURED LACQUERED ALUMINIUM (A011) LACQUERED MDF (V130)

**TIME**

FINISHES: TEXTURED LACQUERED STEEL (A022) OAK (RV)

# DIMENSIONS

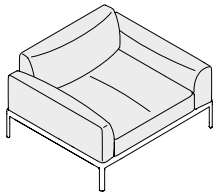

**ALUZEN ARMCHAIR / P01**

cm 110x95 - h cm 65 - h seat cm 41

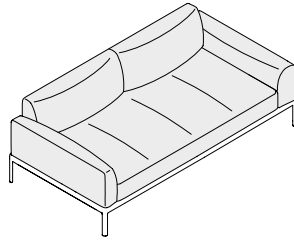

**ALUZEN SOFA 2 / P02**

cm 190x95 - h cm 65 - h seat cm 41

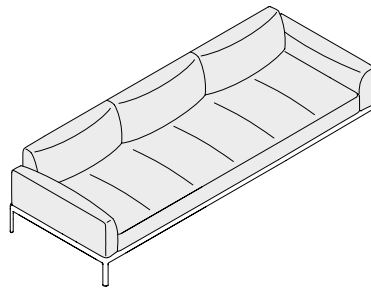

**ALUZEN SOFA 3 / P03**

cm 270x95 - h cm 65 - h seat cm 41

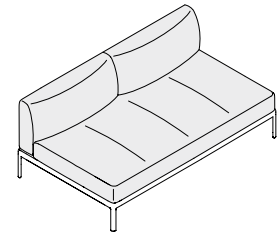

**ALUZEN MODUL 160x95 / P04**

cm 160x95 - h cm 65 - h seat cm 41

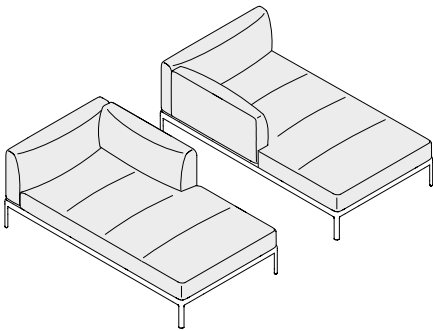

**ALUZEN ANGULAR 175x95 / P05**

cm 175x95 - h cm 65 - h seat cm 41

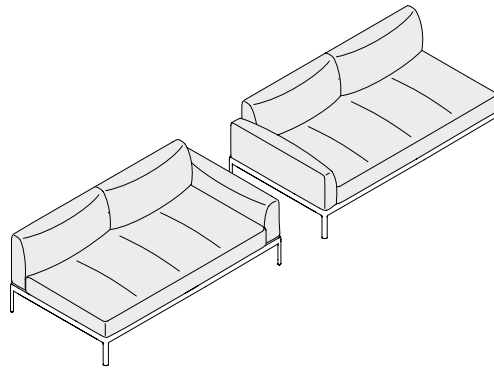

**ALUZEN ENDING 175x95 / P06**

cm 175x95 - h cm 65 - h seat cm 41

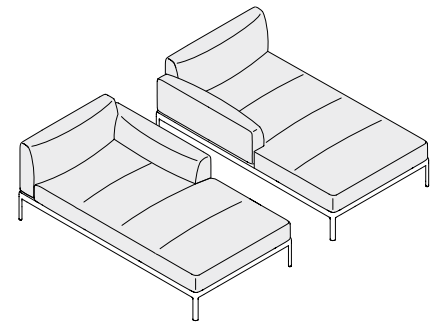

**ALUZEN DORMEUSE 175x95 / P08**

cm 175x95 - h cm 65 - h seat cm 41

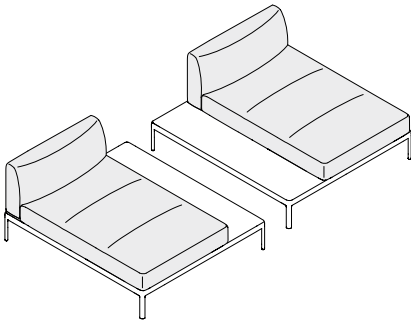

**ALUZEN DORMEUSE 120x135 / P09**

cm 120x135 - h cm 65 - h seat cm 41

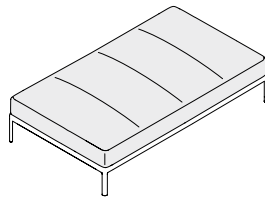

**ALUZEN BENCH 160x95 / P07**

cm 160x95 - h cm 41

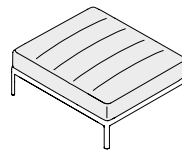

**ALUZEN POUF 80x95 A / P10**

cm 80x95 - h cm 41

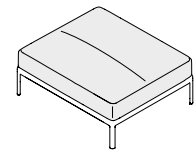

**ALUZEN POUF 80x95 B / P11**

cm 80x95 - h cm 41

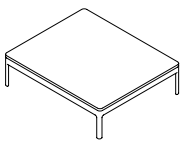

**ALUZEN LOW TABLE 80x95 / P17**

cm 80x95 - h cm 24

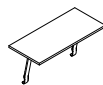

**ALUZEN LOW TABLE 65x30 / P14**

cm 65x30 - h cm 31



**ALUZEN LOW TABLE Ø30 / P15**

ø cm 30 - h cm 31



**ALUZEN LOW TABLE 30x30 / P16**

cm 30x30 - h cm 31

# FINISHES

## STRUTTURA / STRUCTURE / GESTELL / STRUCTURE

Alluminio lucidato  
Aluminium polished  
Aluminium Poliert  
Aluminium poli



AB

Alluminio verniciato goffrato  
Textured lacquered aluminium  
Lackiertes gerauhtes Aluminium  
Aluminium laqué granité



A019

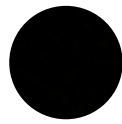

A011



A047



A022



A051

Colori metallizzati disponibili su richiesta.  
Metallic colours available on request.  
Metallic-Farben auf Anfrage erhältlich.  
Couleurs métallisées disponibles sur demande.

## SEDUTA / SEAT / SITZ / ASSISE

Tessuto  
Fabric  
Stoff  
Tissu

**Alias® A**  
Livign I  
Living II

**Camira® A**  
Xtreme  
Urban

**Kvadrat® B**  
Maple  
Remix  
Tonus

**Kvadrat® C**  
Canvas  
Divina  
Divina Melange  
Foss  
Hallingdal 65

**Kvadrat® C**  
Hero  
Steelcut  
Steelcut trio  
Twill Weave

Ecopelle  
Eco-leather  
Kunstleder  
Simili cuir

**Serge Ferrari® A**  
Stamskin® Top

pelle Pelle Frau® SC ColorSphere®  
Pelle Frau® SC ColorSphere® leather  
Pelle Frau® SC ColorSphere® Leder  
Cuir Pelle Frau® SC ColorSphere®



B004



B020



B026



B056



B057



B080

altri colori disponibili su richiesta  
other colours available on request

Pelle Penelope Oggi® Lanilina  
Penelope Oggi® Lanilina Leather  
Penelope Oggi® Lanilina Leder  
Cuir Penelope Oggi® Lanilina



LA02



LA07



LA03



LA06



LA05



LA11



LA01

## PIANO / TOP / TISCHPLATTE / PLATEAU

MDF laccato  
lacquered MDF  
Lackiertes MDF  
MDF laqué



V001

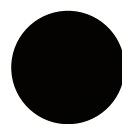

V130



V003



V007



V110

Marmo bianco di Carrara  
Marble bianco Carrara  
Marmo bianco Carrara  
Marbre bianco Carrara



MA01



# ALUZEN SOFT

LUDOVICA + ROBERTO PALOMBA



Il segno elegante e leggero di Ludovica e Roberto Palomba reinterpreta le linee rigorose e geometriche del divano modulare *AluZen* in un'ottica di comfort e relax, dando vita al nuovo *AluZen Soft*. La struttura in alluminio, che nella sua esasperazione lineare, richiama un certo minimalismo geometrico, ospita un sistema di cuscini morbidi e importanti, disegnati per rispondere ai requisiti di ergonomia e comfort.

Das elegante, leichte Zeichen von Ludovica und Roberto Palomba interpretiert die strengen, geometrischen Linien des modularen Sofas *AluZen* neu: mit dem Focus auf mehr Komfort und Entspannung entsteht *AluZen Soft*. Mit ihren strengen und linearen Formen erinnert das Aluminiumgestell an einen gewissen geometrischen Minimalismus und beherbergt es ein System von weichen, hervorstehenden Kissen, die den Anforderungen an Ergonomie und Komfort gerecht werden.

With their light, elegant style, Ludovica + Roberto Palomba reinterpret the rigorous, geometric lines of the modular sofa *AluZen* and achieve a new level of comfort and relaxation, giving life to *AluZen Soft*. The aluminum structure with its very strict and linear shapes recalls a geometric minimalism and houses a system of soft, prominent cushions designed to meet the requirements of ergonomics and comfort.

Le trait élégant et léger de Ludovica et Roberto Palomba réinterprète les lignes rigoureuses et géométriques du canapé modulaire *AluZen* dans une optique de confort et relax, en créant le nouveau *AluZen Soft*. La structure en aluminium, qui dans son exaspération linéaire rappelle un certain minimalisme géométrique, abrite un système de coussins doux et importants, conçus pour répondre aux exigences d'ergonomie et de confort.

# ALUZEN SOFT



ALUZEN SOFT SOFA 3



ALUZEN SOFT ANGULAR + BOX



---

ALUZEN SOFT ENDING



ALUZEN SOFT BENCH



Discover other AluZen Soft configuration examples on [alias.design](https://www.alias.design)  
Scopri altri esempi di configurazione AluZen soft su [alias.design](https://www.alias.design)

AluZen soft collection is available in the outdoor versions.  
La collezione AluZen soft è disponibile anche nella versione outdoor.

## INTERIOR SOLUTIONS



### **ALUZEN SOFT**

FINISHES: TEXTURED LACQUERED ALUMINIUM (A011) FABRIC KVADRAT®

### **SLIM LOUNGE LOW**

FINISHES: TEXTURED LACQUERED ALUMINIUM (A011) FABRIC ALIAS® LIVING I

### **BIPLANE XS**

FINISHES: TEXTURED LACQUERED ALUMINIUM (A011) LACQUERED MDF (V130)

### **SAEN XS**

FINISHES: POLYURETHANE LACQUERED (V130) FULL COLOR LACQUERED (A011)



### **ALUZEN SOFT SOFA 2**

FINISHES: ALUMINIUM (AB) FABRIC KVADRAT®

### **ALUZEN LOW TABLE**

FINISHES: ALUMINIUM (AB) MARBLE MARMO DI CARRARA (MA01)

# DIMENSIONS

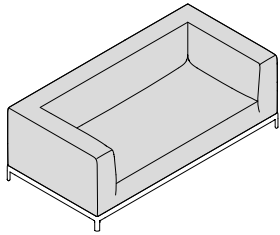

ALUZEN SOFT SOFA 2 / P32 \*

cm 190x95 - h cm 65 - h seat cm 42

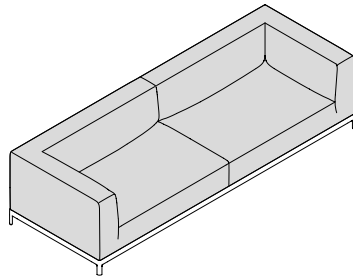

ALUZEN SOFT SOFA 3 / P33 \*

cm 270x95 - h cm 65 - h seat cm 42

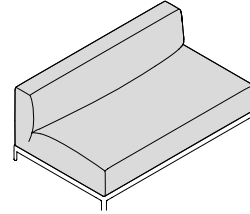

ALUZEN SOFT CENTRAL 160x95 / P34 \*

cm 160x95 - h cm 65 - h seat cm 42

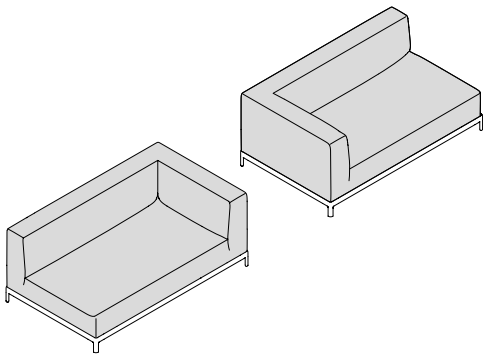

ALUZEN SOFT ANGULAR 160x95 / P37 \*

cm 160x95 - h cm 65 - h seat cm 42

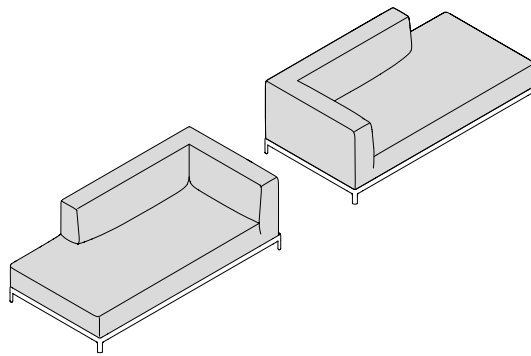

ALUZEN SOFT ANGULAR 190x95 / P38 \*

cm 190x95 - h cm 65 - h seat cm 42

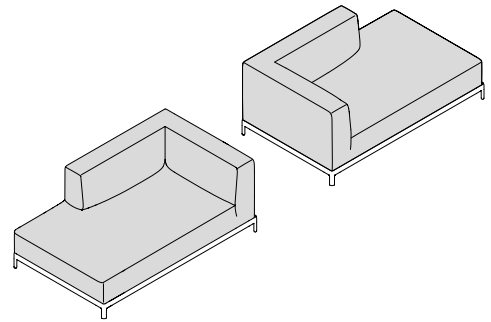

ALUZEN SOFT ENDING 160x95 / P39 \*

cm 160x95 - h cm 65 - h seat cm 42

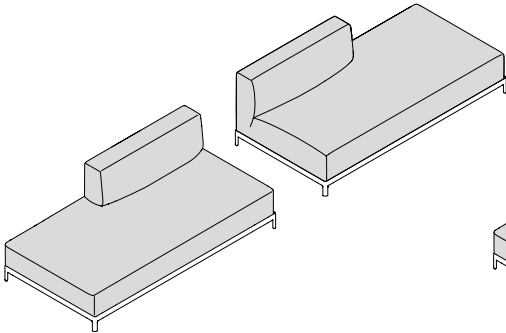

ALUZEN SOFT ENDING 190x95 / P41 \*

cm 190x95 - h cm 65 - h seat cm 42

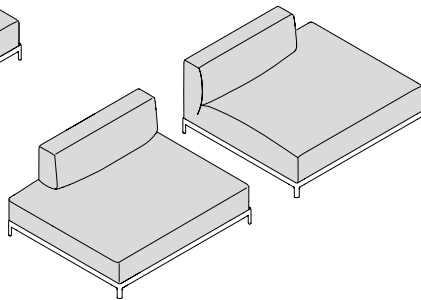

ALUZEN SOFT ENDING 135x120 / P45 \*

cm 135x120 - h cm 65 - h seat cm 42

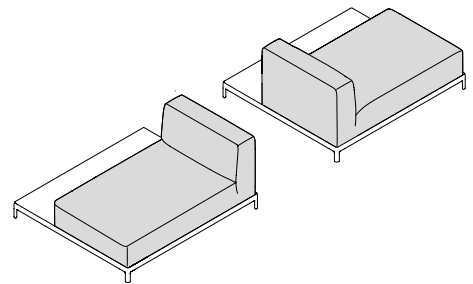

ALUZEN SOFT TOP 135x120 / P46 \*

cm 135x120 - h cm 65 - h seat cm 42

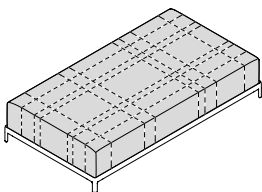

ALUZEN SOFT BENCH / P52

cm 175x95 - h cm 42

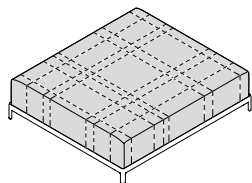

ALUZEN SOFT POUF 135x120 / P50

cm 135x120 - h cm 42

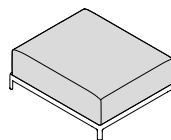

ALUZEN SOFT POUF 80x95 / P51 \*

cm 80x95 - h cm 42

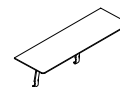

ALUZEN SOFT SHELF / P53

cm 90x30 - h cm 31

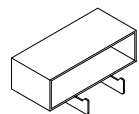

ALUZEN SOFT BOX / P54

cm 90x40 - h cm 38

La versione outdoor è sfoderabile.  
The outdoor version has removable covers.

\* AVAILABLE FOR OUTDOOR



# FINISHES

## STRUTTURA / STRUCTURE / GESTELL / STRUCTURE

Alluminio lucidato  
Polished aluminium  
Aluminium Poliert  
Aluminium poli



AB

Alluminio verniciato goffrato  
Textured lacquered aluminium  
Lackiertes gerauhtes Aluminium  
Aluminium laqué granité



A019



A011



A047



A022



A051

Alluminio verniciato metallizzato  
Metallic lacquered aluminium  
Aluminium metallic lackiert  
Aluminium laqué métallisé



A048



A049



A050

## SEDUTA / SEAT / SITZ / ASSISE

Tessuto  
Fabric  
Stoff  
Tissu

Alias® A  
Livign I  
Living II  
Living Outdoor

Kvadrat® B  
Maple  
Remix  
Tonus

Kvadrat® C  
Canvas  
Divina  
Divina Melange  
Foss  
Hallingdal 65

Kvadrat® C  
Harald  
Hero  
Steelcut  
Steelcut trio  
Twill Weave

Tempotest® A

Camira® A  
Xtreme  
Urban

Pelle Pelle Frau® SC ColorSphere®  
Pelle Frau® SC ColorSphere® leather  
Pelle Frau® SC ColorSphere® Leder  
Cuir Pelle Frau® SC ColorSphere®



B004



B020



B026



B056



B057



B080

altri colori disponibili su richiesta  
other colours available on request

Pelle Penelope Oggi® Lanilina  
Penelope Oggi® Lanilina leather  
Penelope Oggi® Lanilina Leder  
Cuir Penelope Oggi® Lanilina



LA02



LA07



LA03



LA06

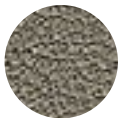

LA05



LA11



LA01

## PIANO / TOP / TISCHPLATTE / PLATEAU

Impiallacciato  
Veneered  
Furnierung  
Plaqué

Rovere naturale  
Natural oak  
Eiche natur  
Chêne naturel

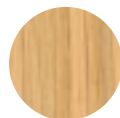

RV

Rovere grigio cenere  
Ash grey oak  
Eiche aschgrau  
Chêne gris cendré



RC

Gres  
Gres stoneware  
Feinsteinzeug  
Grès

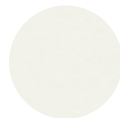

CE10



CE13



CE12



CE11



# E LA NAVE VA

ATELIER OÏ



Il percorso di ricerca e l'approccio costruttivista dello studio Atelier Oï è coerente al DNA di Alias che privilegia i principi costruttivi al disegno formale. Il divano è strutturato con un sistema di doghe a vista ispirato alla struttura degli scafi nautici in legno, le centine elastiche sorreggono i cuscini e sono fissate a due binari in legno sospesi su eleganti piedi in alluminio. Le forme sono riportate alla loro essenza per favorire l'attenzione sui materiali, che assumono essi stessi una forte componente stilistica.

Der Forschungsansatz und die konstruktivistische Herangehensweise von Atelier Oï stehen im Einklang mit Alias DNA, die konstruktiven Prinzipien vor formalem Design bevorzugt. Das Sofa besteht aus einem System von sichtbaren Dauben, das von der hölzernen Struktur der Schiffsrümpfe inspiriert ist. Die elastischen Rippen stützen die Kissen und sind an zwei Holzschienen befestigt, die an eleganten Aluminiumfüßen aufgehängt sind. Die Formen sind essentiell, um sich auf die Materialien zu fokussieren, die ihrerseits eine starke stilistische Komponente aufweisen.

The research path and constructivist approach of Atelier Oï is consistent with Alias DNA, which privileges constructive principles over formal design. The sofa is structured with a system of visible slats inspired by the structure of wooden nautical hulls; the elastic ribs support the cushions and are fixed to two wooden rails, which are suspended on elegant aluminium feet. The forms are restored to their essence focusing the attention on the materials, which take on a strong stylistic component.

Le parcours de recherche et l'approche constructiviste du studio Atelier Oï est cohérent avec l'ADN d'Alias qui privilégie les aspects de la construction par rapport au dessin formel. Le canapé est structuré à partir d'un système de lattes apparentes inspiré par la structure des coques nautiques en bois, les nervures élastiques soutiennent les coussins et sont fixées à deux rails en bois suspendus sur d'élégants pieds en aluminium. Les formes sont ramenées à leur essence pour attirer l'attention sur les matériaux, qui assument eux-mêmes une forte composante stylistique.

## E LA NAVE VA



E LA NAVE VA ARMCHAIR



E LA NAVE VA SOFA

Il principio costruttivo di *e la nave va*, basato sulla moltiplicazione di un elemento, si esprime in un design decisamente grafico che viene declinato in un divano e in una poltrona.

The construction principle of *e la nave va* is based on the multiplication of an element and it is expressed in a graphic design, which is declined in a sofa and an armchair.

Das Konstruktionsprinzip von *e la nave va* basiert auf der Multiplikation eines Elements und kommt in einem grafischen Design zum Ausdruck, das in einem Sofa und einem Sessel dekliniert wird.

Le principe de construction de *e la nave va*, basé sur la multiplication d'un élément, s'exprime dans un design résolument graphique qui se décline en un canapé et un fauteuil.

## OVERVIEW



Sofa composed with curved oak multilayer slats; structure in veneered beech plywood and feet in lacquered die-cast aluminium.

*Divano composto da telaio con doghe curve in multistrato di rovere; struttura in legno multistrato di faggio impiallacciato e piedi in fusione di alluminio verniciato.*



The slats are tied with a removable cover in the same finish of the seat.

*Le doghe sono legate con una fascia sfoderabile della stessa finitura della seduta.*

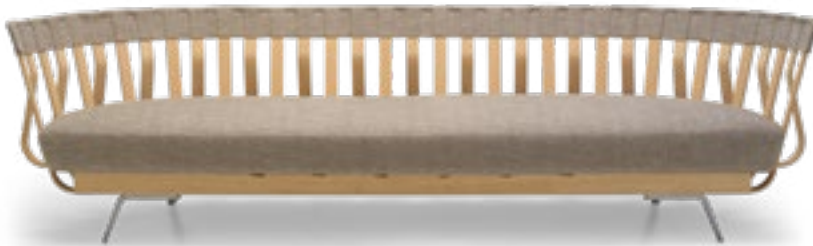

Seat and cushions covered in fabric or leather.

*Seduta e cuscini rivestiti in tessuto o pelle.*



## E LA NAVE VA SOFA 45



### EXAMPLE CONFIGURATIONS



Photo credits @Simon Ricklin

Il modulo *e la nave va 45* consente di creare configurazioni curvilinee, garantendo alto livello di personalizzazione.

*E la nave va 45* module allows you to create curvilinear configurations, guaranteeing deep customisation.

Das modul *e la nave va 45* ermöglicht die Erstellung von gekrümmten Konfigurationen und garantiert ein hohes Maß an Individualität.

Le module *e la nave va 45* permet de créer des configurations curvilignes, en garantissant un niveau particulièrement élevé de personnalisation.

## DIMENSIONS

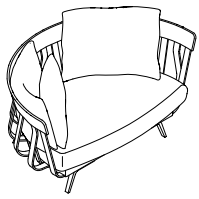

E LA NAVE VA ARMCHAIR / 02B

cm 143x88 - h cm 72 - h seat cm 40

Back cushions included:  
2 pcs size 60x50 cm / 1 pcs size 70x35 cm

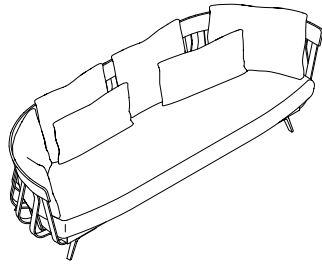

E LA NAVE VA SOFA / 02A

cm 260x88 - h cm 72 - h seat cm 40

Back cushions included:  
4 pcs size 60x50 cm / 2 pcs size 70x35 cm

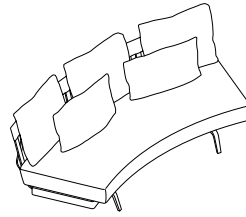

E LA NAVE VA SOFA 45 / 02D

cm 210x88 - h cm 72 - h seat cm 40

Back cushions included:  
3 pcs size 60x50 cm / 2 pcs size 70x35 cm

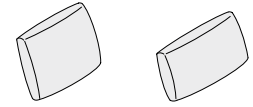

E LA NAVE VA CUSHION / 02C

cm 50x60 - cm 35x70

## FINISHES

### STRUTTURA / STRUCTURE / GESTELL / STRUCTURE

Alluminio verniciato goffrato  
Textured lacquered aluminium  
Lackiertes gerauhtes Aluminium  
Aluminium laqué granité



A019



A011



A047



A022



A051

Alluminio verniciato metallizzato  
Metallic lacquered aluminium  
Aluminium metallic lackiert  
Aluminium laqué métallisé



A048



A049



A050

### SEDUTA / SEAT / SITZ / ASSISE

Pelle Pelle Frau® SC ColorSphere®  
Pelle Frau® SC ColorSphere® leather  
Pelle Frau® SC ColorSphere® Leder  
Cuir Pelle Frau® SC ColorSphere®



B004



B020



B026



B056



B057



B080

altri colori disponibili su richiesta  
other colours available on request

Pelle Penelope Oggi® Lanilina  
Penelope Oggi® Lanilina leather  
Penelope Oggi® Lanilina Leder  
Cuir Penelope Oggi® Lanilina



LA02



LA07



LA03



LA06



LA05



LA11

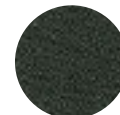

LA01

Tessuto  
Fabric  
Stoff  
Tissu

Alias® A  
Livign I  
Living II

Camira® A  
Xtreme  
Urban

Kvadrat® B  
Maple  
Remix  
Tonus

Kvadrat® C  
Canvas  
Divina  
Divina Melange  
Foss

Hallingdal 65  
Harald  
Hero  
Steelcut  
Steelcut trio  
Twill Weave

### STRUTTURA / STRUCTURE / GESTELL / STRUCTURE

Impiallacciato  
Veneered  
Furnierung  
Plaqué

Rovere naturale  
Natural oak  
Eiche natur  
Chêne naturel

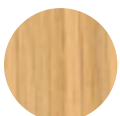

RV

Rovere grigio cenere  
Ash grey oak  
Eiche aschgrau  
Chêne gris cendré



RC





# ELEVEN

PEARSONLLOYD



Volumi compatti. Estrema pulizia visiva. E come elemento caratterizzante le gambe in alluminio a cui si agganciano i braccioli e lo schienale. *Eleven* è un sistema di sedute da uno, due e tre posti disegnato da PearsonLloyd per offrire un'eleganza trasversale. Ideale negli scenari domestici come negli spazi collettivi, la collezione entra nel mondo Alias con uno spirito tecnologico affine all'identità del marchio.

Kompakte Volumen. Extreme visuelle Reinheit. Ein kennzeichnendes Element: die Aluminiumbeine, an welchen die Rückenlehne und Armlehnen befestigt sind. *Eleven* wurde von PearsonLloyd entworfen und ist eine Polsterkollektion mit einem, zwei oder drei Sitzplätzen, die eine übergreifende Eleganz anbietet. Ideal in Wohn- und öffentlichen Räumen tritt die Kollektion in Alias Welt mit einem technologischen Geist ein, der die Identität der Marke widerspiegelt.

Compact volumes. Essential clean-cut lines. One distinctive feature: the aluminium legs to which back and armrests cushions are anchored. *Eleven* is a system of one, two and three-seater sofas designed by PearsonLloyd and it offers a transversal elegance. This collection is ideal for both domestic interiors and collective spaces and it becomes part of Alias world with a technological spirit, thus reflecting the brand's identity.

Des volumes compacts. Une extrême sobriété visuelle. Élément caractéristique les pieds en aluminium auxquels le dossier et les accoudoirs se fixent. *Eleven* est un système d'assises à une, deux ou trois places dessiné par PearsonLloyd pour offrir une élégance transversale. Idéale pour la maison ou les collectivités, la collection entre dans le monde Alias avec un esprit technologique proche de l'identité de la marque.

# ELEVEN



ELEVEN ARMCHAIR



ELEVEN SOFA 2



ELEVEN SOFA 3

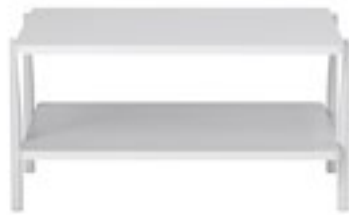

ELEVEN LOW TABLE DOUBLE



ELEVEN LOW TABLE SINGULAR

## DIMENSIONS

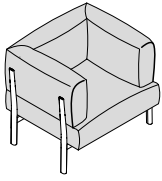

ELEVEN ARMCHAIR / 860

cm 85x74 - h cm 72 - h seat cm 44

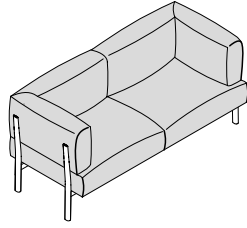

ELEVEN SOFA 2 / 861

cm 163x74 - h cm 72 - h seat cm 44

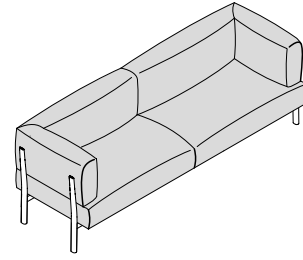

ELEVEN SOFA 3 / 862

cm 213x74 - h cm 72 - h seat cm 44

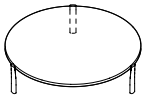

ELEVEN LOW TABLE SINGULAR / 955

ø cm 90 - h cm 22,5  
cm 120x70 - h cm 22,5

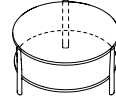
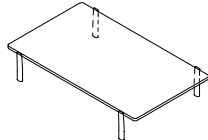

ELEVEN LOW TABLE DOUBLE / 954

ø cm 70 - h cm 37,5  
cm 70x70 - h cm 37,5

## FINISHES

### STRUTTURA / STRUCTURE / GESTELL / STRUCTURE

Alluminio lucidato  
Polished aluminium  
Aluminium Poliert  
Aluminium poli



AB

Alluminio verniciato goffrato  
Textured lacquered aluminium  
Lackiertes gerauhtes Aluminium  
Aluminium laqué granité



A019



A011



A047



A022



A051

### SEDUTA / SEAT / SITZ / ASSISE

Tessuto  
Fabric  
Stoff  
Tissu

**Alias® A**  
Livign I  
Living II

**Camira® A**  
Xtreme  
Urban

**Kvadrat® B**  
Maple  
Remix  
Tonus

**Kvadrat® C**  
Canvas  
Divina  
Foss  
Hallingdal 65  
Hero  
Steelcut  
Steelcut trio

Pelle Pelle Frau® SC ColorSphere®  
Pelle Frau® SC ColorSphere® leather  
Pelle Frau® SC ColorSphere® Leder  
Cuir Pelle Frau® SC ColorSphere®



B004



B020



B026



B056



B057



B080

altri colori disponibili su richiesta  
other colours available on request

MDF laccato  
Lacquered MDF  
MDF lackiert  
MDF laqué



V003



V110



# ELEVEN HIGH BACK

PEARSONLLOYD



La collezione di imbottiti *eleven*, progettata dal duo britannico PearsonLloyd, si amplia con l'introduzione di una nuova variante che ne rappresenta il naturale completamento. La proposta *eleven high back*, disponibile sulla poltrona e sui divani 2 o 3 posti, prevede pannelli laterali e posteriori che si fissano alle gambe in alluminio, creando una zona protetta di privacy, ideale per gli spazi di lavoro.

Die Polsterkollektion *eleven*, entworfen vom britischen Duos PearsonLloyd, wird durch eine neue Variante erweitert, die eine natürliche Komplettierung darstellt. Das Produkt *eleven high back* ist als Sessel und 2- oder 3-sitzige Sofa erhältlich und hat Seiten- und Rückpaneele fixiert an den Aluminiumbeinen: somit schafft es eine Privatsphäre ideal fuer Arbeitsumgebungen.

The *eleven* sofa collection designed by the British duo PearsonLloyd has been extended with a new version which naturally completes the collection. The *eleven high back* version is available as armchair and two or three-seater sofas and it features side and rear panels fixed to the aluminium legs creating a protected area for privacy, ideal for working areas.

La collection de canapés rembourrés *eleven*, projetée par le duo britannique PearsonLloyd, accueille une nouvelle variante qui est son complément naturel. L'article *eleven high back*, disponible pour le fauteuil et les canapés 2 ou 3 places, prévoit des panneaux latéraux et postérieurs qui se fixent sur le piètement en aluminium afin de préserver l'intimité, idéal pour les espaces de travail.

## ELEVEN HIGH BACK



ELEVEN HIGH BACK 1 / ELEVEN HIGH BACK 2



ELEVEN HIGH BACK 3



La collezione eleven high back, si arricchisce di proposte cable preconfigurate, ideali per rispondere alle esigenze del lavoro contemporaneo. La famiglia di imbottiti si amplia così delle varianti elettrificate, rivelando la sua natura versatile e funzionale.

The eleven high back collection, is extended with preconfigured cable solutions, ideal for responding to the needs of contemporary work. The family of upholstered furniture will be expanded with electrified variants, revealing its versatile and functional nature.

Die Kollektion eleven high back wird durch vorkonfigurierte Kabelvorschläge bereichert, die ideal für die Bedürfnisse der zeitgenössischen Arbeit sind. Die Familie von Polstermöbeln und Tischen wird daher um elektrifizierte Varianten erweitert, die ihren vielseitigen und funktionalen Charakter offenbaren.

La collection eleven high back, s'enrichit de propositions câblées et préconfigurées, idéales pour répondre aux besoins du monde du travail contemporain. La famille de meubles rembourrés conçue par le duo britannique PearsonLloyd s'agrandit avec des versions électrifiées, révélant ainsi son caractère polyvalent et fonctionnel.

## OVERVIEW

The panels are made of polyurethane foam covered in Kvadrat®, Camira® or Alias® Living fabrics. The panels provide acoustic insulation for the used.

*I pannelli sono realizzati in poliuretano espanso rivestiti in tessuto Kvadrat®, Camira® o Alias® Living. Le pannellature consentono di isolare acusticamente il fruitore.*

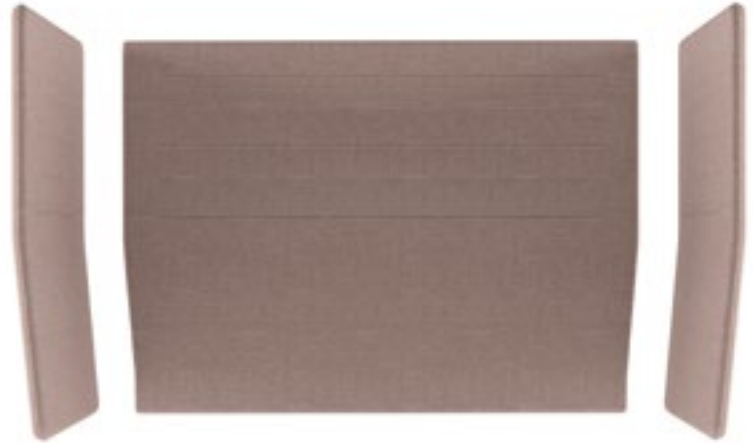

Seat cushion, back and arm removable covers. Covered in fabrics Kvadrat®, Camira® or Alias® Living.

*Seduta, schienale e braccioli sfoderabili. Rivestiti in tessuto Kvadrat®, Camira® o Alias® Living.*



Structure in polished aluminium or textured laquered.

*Struttura in alluminio lucidato o verniciato goffrato.*

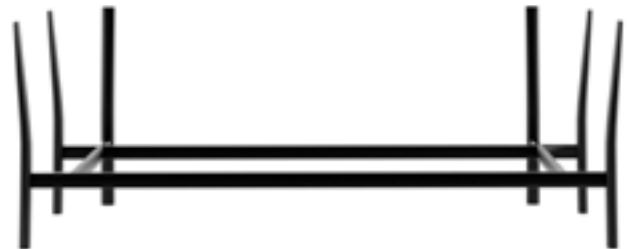

The Eleven high collection also includes workstations. Discover Eleven high desk on page 136

La collezione Eleven high comprende anche postazioni di lavoro. Scopri Eleven high desk a pagina 136

NOTA: è possibile scegliere un colore e/o tessuto diverso per il rivestimento dei pannelli rispetto al rivestimento dei cuscini della seduta, dello schienale e dei braccioli.  
NOTE: it is possible to have panels covered with different colours and/or fabrics than the seat, backrest and arms cushions.  
HINWEIS: Die Paneele können in anderen Farben/Stoffen bezogen werden als die Armlehnen, Sitz und Rücken Kissen.  
NOTE: il est possible de choisir une couleur et/ou tissu différent pour le revêtement des panneaux par rapport au revêtement des coussins de l'assise, du dossier et des accoudoirs.

## ELEVEN HIGH BACK WORK



ELEVEN HIGH BACK WORK

*Eleven high back work* vede l'inserimento di un piano di lavoro che trasforma il divano in una capsula office pensata per consentire all'utilizzatore di portare avanti le sue attività, nei moderni spazi soft seating di lounge, aeroporti e alberghi.

*Eleven high back work* is proposed with a top specially designed to convert the sofa into an office "capsule" conceived to allow the users to carry on their activities in the modern soft seating lounge areas, airports and hotels.

In *Eleven high back work* wird eine Arbeitsfläche integriert, die das Sofa in eine Büro kapsel verwandelt. Diese ermöglicht dem Benutzer, seine Tätigkeiten in den modernen lounge Sitzbereichen, Flughäfen und Hotels fortzusetzen.

*Eleven high back work* prévoit l'intégration d'un plan de travail, qui transforme le canapé en un bureau capsule imaginé pour permettre à l'utilisateur d'exercer ses activités dans les espaces lounges présents dans les aéroports et les hôtels.



Le nuove versioni elettrificate della collezione arricchiscono la proposta Alias dedicata al contract, inteso come nuovo ambito di applicazione dell'office che pone le necessità dell'uomo al centro del progetto.

The new electrified versions of the collection enrich Alias proposal dedicated to contract, intended as a new field of application for the office that places human needs at the centre of the project.

Die neuen elektrifizierten Versionen der Kollektion bereichern Alias Angebot für den Objektbereich, der als neuer Anwendungsbereich für das Büro verstanden wird und die Bedürfnisse des Menschen in den Mittelpunkt des Projekts stellt.

Les nouvelles versions électrifiées de la collection enrichissent la proposition Alias dédiée au secteur des espaces d'accueil et de travail, conçu comme un nouveau champ d'application pour le bureau qui place les besoins de l'homme au centre du projet.



## ELEVEN HIGH BACK PRIVACY



Il pannello centrale è removibile e fissato alle due sedute tramite cerniere.

The central panel is removable and is attached to the two seats by a zip.

ELEVEN HIGH BACK PRIVACY



The panel with the monitor set-up is a unique whole piece and is directly fixed to the two seats.

Il pannello con la predisposizione per il monitor è unico e fissato direttamente alle due sedute.

ELEVEN HIGH BACK PRIVACY monitor

Per *eleven high back* e *eleven high back privacy*, disponibili nelle versioni poltrona e divani a 2 o 3 posti, e *eleven high back work* è previsto un accessorio multipresa, ideale per il collegamento e la ricarica giornaliera dei dispositivi mobili, che viene agganciato alla struttura in alluminio sottostante le sedute. *Eleven high back privacy* diventa ancora più funzionale grazie ai nuovi pannelli che attraverso un gancio integrato consentono di fissare un monitor.

*Eleven high back* and *eleven high back privacy*, available as armchair and 2- or 3-seater sofa, and *eleven high back work* offer a multi-socket optional fixed to the aluminium structure under the seats, ideal to connect and charge mobile devices. *Eleven high back privacy* becomes even more functional thanks to the new panels where you can install a monitor thanks to an integrated hook.

Die Kollektionen *eleven high back* und *eleven high back privacy*, erhältlich als Sessel und 2- oder 3-Sitzer-Sofa, und *eleven high back work* sind mit einem Multi-socket-Zubehör ausgestattet, das auf dem Aluminiumgestell unter dem Sitz installiert wird und für den täglichen Anschluss und das Aufladen von mobilen Geräten ideal ist. *Eleven high back privacy* wird noch funktionaler durch neue Paneele, an denen ein Monitor über einen integrierten Haken befestigt werden kann.

Pour *eleven high back* et *eleven high back privacy*, disponibles en version fauteuil et canapé 2 ou 3 places et pour *eleven high back work*, il existe un accessoire multiprise, idéal pour la connexion et la recharge quotidienne des appareils mobiles, qui se fixe sur la structure en aluminium située sous les assises. *Eleven high back privacy* devient encore plus fonctionnel grâce aux nouveaux panneaux qui, à travers un crochet intégré, permettent de fixer un écran.

## POSITION OF THE COMPACT CABLING SYSTEM

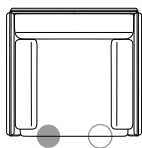

eleven high back 1 / 865  
1 set-up suggested

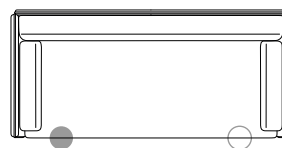

eleven high back 2 / 863  
1 set-up suggested

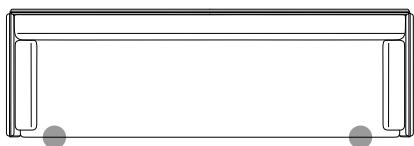

eleven high back 3 / 864  
2 set-up suggested

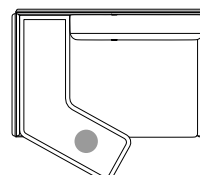

eleven high back work / 869  
1 set-up suggested

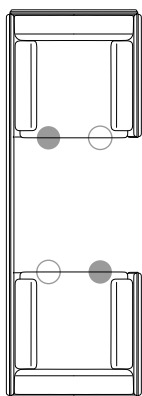

eleven high back privacy 1 / 866  
2 set-up suggested

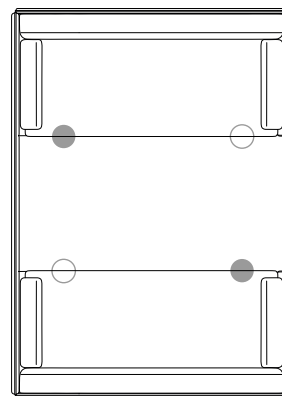

eleven high back privacy 2 / 867  
2 set-up suggested

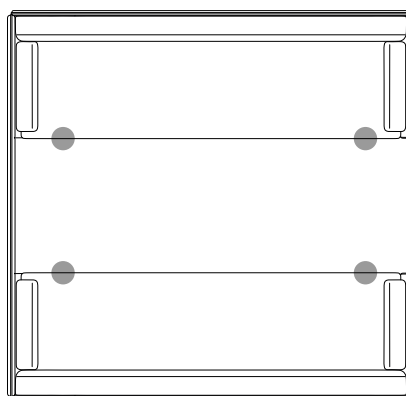

eleven high back privacy 3 / 868  
4 set-up suggested



21Z

Su richiesta predisposizione per elettrificazione  
Electrical set-up available on request.  
Voreinstellung für die Elektrifizierung verfügbar  
auf Anfrage.  
Sur demande, prédisposition pour  
l'électrification

● Posizione del sistema di cablaggio compatto.  
Position of the compact cabling system.  
Position des kompakten Verkabelungssystems.  
Position du système de câblage compact.

○ Opzione della posizione del sistema di cablaggio compatto.  
Positioning option of the compact cabling system.  
Option Positionierung des kompakten Verkabelungssystems.  
Option de positionnement du système de câblage compact.

## DIMENSIONS

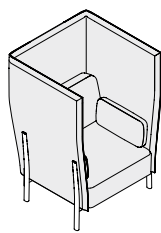

**ELEVEN HIGH BACK 1 / 865**

cm 80x75 - h cm 137 - h seat cm 44

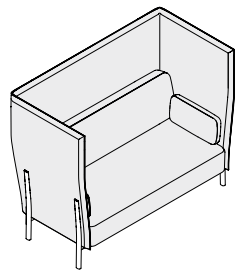

**ELEVEN HIGH BACK 2 / 863**

cm 165x75 - h cm 137 - h seat cm 44

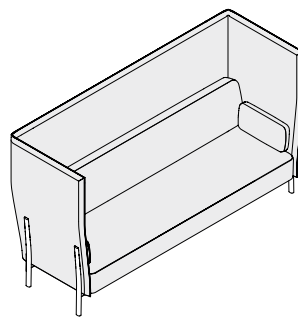

**ELEVEN HIGH BACK 3 / 864**

cm 215x75 - h cm 137 - h seat cm 44

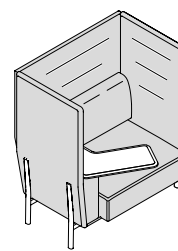

**ELEVEN HIGH BACK WORK / 869**

cm 120x100 - h cm 137 - h seat cm 44

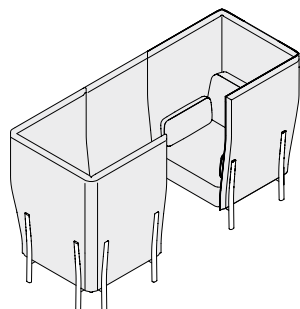

**ELEVEN HIGH BACK PRIVACY 1 / 866**

cm 80x230 - h cm 137 - h seat cm 44

Disponibile con predisposizione per monitor 866\_M  
Available with monitor set-up 866\_M

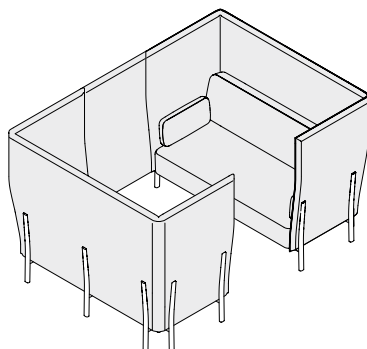

**ELEVEN HIGH BACK PRIVACY 2 / 867**

cm 165x230 - h cm 137 - h seat cm 44

Disponibile con predisposizione per monitor 867\_M  
Available with monitor set-up 867\_M

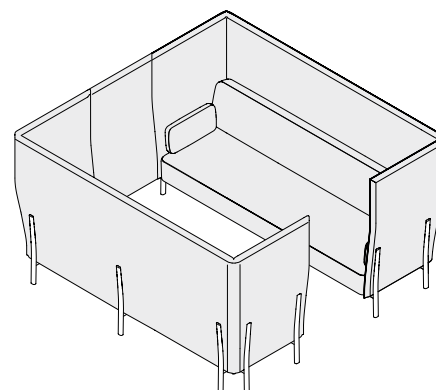

**ELEVEN HIGH BACK PRIVACY 3 / 868**

cm 215x230 - h cm 137 - h seat cm 44

Disponibile con predisposizione per monitor 868\_M  
Available with monitor set-up 868\_M

## FINISHES

### STRUTTURA / STRUCTURE / GESTELL / STRUCTURE

Alluminio lucidato  
Polished Aluminium  
Aluminium poliert  
Aluminium poli



AB

Alluminio verniciato goffrato  
Textured lacquered aluminium  
Lackiertes gerauhtes Aluminium  
Aluminium laqué granité



A019



A011



A047



A022



A051



A039



A041



A042

### RIVESTIMENTO PANNELLI & SEDUTA / PANEL'S COVER & SEAT / PANEELBEZUG & SITZ / REVÊTEMENT PANNEAUX & ASSISE

Tessuti  
Fabric  
Stoff  
Tissu

**Alias® A**  
Livign I  
Living II

**Camira® A**  
Xtreme  
Urban

**Kvadrat® B**  
Maple  
Remix  
Tonus

**Kvadrat® C**  
Canvas  
Divina  
Foss

Hallingdal 65  
Hero  
Steelcut  
Steelcut trio

### PIANO (869) / TOP (869) / TISCHPLATTE (869) / PLATEAU (869)

Impiallacciato  
Veneered  
Furnierung  
Plaqué

Rovere naturale  
Natural oak  
Eiche natur  
Chêne naturel

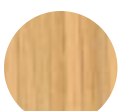

RV

Rovere grigio cenere  
Ash grey oak  
Eiche aschgrau  
Chêne gris cendré



RC



# FLEXUS

PAOLO RIZZATTO



*Monoflexus* è l'iconico imbottito che nel 2002 entra a far parte della collezione *Flexus* di Alias, progettata dall'architetto e designer Paolo Rizzatto. L'aspetto curvilineo di *monoflexus* in pianta conferisce all'oggetto una non banale versatilità, rendendosi adatto a qualunque parte di un determinato ambiente, persino in quelli più insoliti come gli angoli, dove in questo caso si stabilisce un contrasto armonioso tra la sinuosità dell'oggetto e il rigore dell'incontro tra due pareti.

*Monoflexus* ist das ikonische Polstermöbel, das 2002 Teil der *Flexus*-Kollektion von Alias wurde, die vom Architekten und Designer Paolo Rizzatto entworfen wurde. Das geschwungene Erscheinungsbild von *Monoflexus* verleiht dem Objekt eine innovative Vielseitigkeit, die es für jeden Umgebung und Platz geeignet macht, auch für die ungewöhnlichsten wie z. B. Ecken: In diesem Fall entsteht ein harmonischer Kontrast zwischen dem kurvenreichen Objekt und der Strenge des Zusammentreffens von zwei Wänden.

*Monoflexus* is the iconic upholstered armchair that in 2002 became part of *Flexus* collection, designed by the architect and designer Paolo Rizzatto for Alias. With its curvilinear layout *monoflexus* acquires a sophisticated versatility and it is therefore suitable for any environment and place, even the most unusual such as corners, where it creates a pleasing contrast between the sinuosity of the object and the rigour of two walls meeting.

*Monoflexus* est le meuble rembourré iconique qui, en 2002, a fait partie de la collection *Flexus* d'Alias, conçue par l'architecte et designer Paolo Rizzatto. L'aspect curviligne de *monoflexus* en plante confère à l'objet une versatilité non négligeable, qui le rend apte à s'insérer dans n'importe quelle partie d'un certain environnement, même dans les coins les plus inhabituels, où dans ce cas, un contraste harmonieux est établi entre la sinuosité de l'objet et la rigueur de la rencontre entre deux murs.

## MONOFLEXUS



## INTERIOR SOLUTIONS



**MONOFLEXUS**

FINISHES: TEXTURED LACQUERED ALUMINIUM (A011) EMMECIA FABRIC BLACK

**BIPLANE XS**

FINISHES: TEXTURED LACQUERED ALUMINIUM (A011) LACQUERED MDF (V130)

## DIMENSIONS

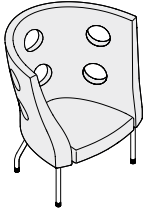

### MONOFLEX / 911

cm. 96x77 - h. cm. 106 - h. seat cm. 44

La seduta inoltre interpreta meglio di altri la crescente tendenza degli open space. Infatti la diffusione di ambienti sia residenziali che di lavoro, privi di ingombri strutturali, ha permesso al designer di creare un oggetto che assume la doppia funzione di dividere gli spazi in modo creativo, sfruttando la proporzione tra altezza e profondità dello schienale e della seduta.

The armchair interprets most effectively the growing popularity of open spaces. The widespread use of residential and office environments free from structural obstacles, in fact, enabled the designer to create an object that takes on the dual function of partitioning space in a creative manner, by putting to use the proportions between the height and depth of the armchair's back and seat.

Der Sessel interpretiert auch den zunehmenden Trend zu offenen Räumen besser als andere. Die Ausbreitung von Wohn- und Arbeitsumgebungen, die frei von strukturellen Belastungen sind, hat es nämlich ermöglicht, ein Objekt zu schaffen, das die doppelte Funktion einer kreativen Raumaufteilung übernimmt, indem es das Verhältnis zwischen Höhe und Tiefe von Ruckelehne und Sitz ausnutzt.

Le siège interprète également, mieux que d'autres, la tendance croissante des espaces ouverts. En fait, la diffusion des environnements résidentiels et de travail sans encombrement structurel, a permis au concepteur de créer un objet qui assume la double fonction de diviser les espaces de manière créative, en exploitant la proportion entre la hauteur et la profondeur du dossier et de l'assise.

## FINISHES

Alluminio verniciato liscio  
Lacquered Aluminium  
Lackiertes aluminium  
Aluminium laqué lisse



A011

Tessuto EMMECIA nero  
EMMECIA Fabric black  
Stoff EMMECIA schwarz  
Tissu EMMECIA noir



MC10





# GRAN KOBI

PATRICK NORGUET



Patrick Norguet disegna *gran kobi* una poltrona lounge molto raffinata dal grande comfort; le geometrie sinuose ma al tempo stesso asciutte rappresentano la naturale evoluzione della collezione di sedute *kobi*. *Gran kobi* è una poltrona bassa dalle dimensioni generose, una seduta molto versatile. Ideale nei salotti domestici e nelle sale d'attesa, sino alle situazioni di ufficio informale, induce un atteggiamento di relax, garantendo massimo comfort.

Patrick Norguet hat *gran kobi* entworfen, einen sehr raffinierten Lounge Sessel mit hohem Komfort. Die kurvenreiche aber zugleich schlichte Geometrie repräsentiert die natürliche Evolution des *kobi* Stuhl-Kollektion. *Gran kobi* ist ein niedriger Sessel mit großzügigen Maßen, auf dem man sich entspannen kann. Ideal sowohl in Wohnzimmer und Warteräume als auch in informellen Büros, der eine entspannende Stimmung mit maximalem Komfort verleiht.

Patrick Norguet designs *gran kobi*, a very refined lounge chair with maximum comfort. The curvy but also plain geometry represents the natural evolution of the chairs of *kobi* collection. *Gran kobi* is a generously sized low armchair, a very versatile seat. Ideal for use in domestic lounges and public waiting rooms, or even in informal office contexts, *gran kobi* inspires a relaxed attitude and guarantees maximum comfort.

Patrick Norguet dessine *gran kobi* un fauteuil lounge très raffiné de grand confort; les géométries sinueuses mais en même temps sobres représentent l'évolution naturelle de la collection de sièges *kobi*. *Gran kobi* est un fauteuil bas aux dimensions généreuses, un siège très polyvalent. Idéal dans les salons et les salles d'attente, sans oublier les espaces de bureaux informels, *gran kobi* favorise le relax, en garantissant un maximum de confort.

# GRAN KOBI



GRAN KOBI + PAD / POUF



GRAN KOBI OUTDOOR



GRAN KOBI ESSENTIEL



Gran kobi *essentiel* è possibile scegliere due colori e materiali diversi per il rivestimento fronte e retro della seduta.  
 Gran kobi *essentiel* it is possible to choose different colours and materials for front & back of the seat.  
 Gran kobi *essentiel* es ist möglich, verschiedene Farben und Materialien für die Vorder- und Rückseite des Sitzes.  
 Gran kobi *essentiel* il est possible de choisir deux couleurs et matériaux différents pour le revêtement intérieur et extérieur de l'assise.

La scocca di *gran kobi essentiel* viene privata degli intrecci in tondino d'acciaio saldato, diventando un elemento strutturale dalle dimensioni generose realizzato in poliuretano espanso completamente rivestito in tessuto o pelle. Ideale nei salotti domestici e nelle sale d'attesa, *gran kobi essentiel* si abbina perfettamente al pouf in collezione, garantendo massimo comfort.

The shell of *gran kobi essentiel* has been deprived of the woven welded round steel wire and it became a generously sized structural element made of polyurethane foam, fully covered with fabric or leather. Ideal in domestic livings and waiting rooms *gran kobi essentiel* is a perfect match for the ottoman of the collection and it guarantees maximum comfort.

Die Schale von *gran kobi essentiel* hat kein geschweißtes Rundstahlgeflecht mehr und wird ein Strukturelement aus Polyurethanschäum mit großzügigen Abmessungen, komplett bezogen mit Stoff oder Leder. Ideal für Wohnzimmer oder Warteräume passt der *gran kobi essentiel* perfekt zum Hocker der Kollektion und garantiert maximalen Komfort.

La coque de *gran kobi essentiel* abandonne les tressages en rond d'acier soudé pour devenir un élément structurel aux dimensions généreuses, réalisé en polyuréthane expansé, entièrement revêtu de tissu ou cuir. Idéal dans les salons et les salles d'attente, *gran kobi essentiel* s'harmonise parfaitement avec le pouf de la collection, pour garantir un maximum de confort.

# DIMENSIONS

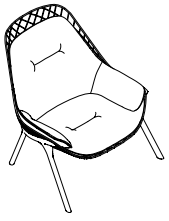

GRAN KOBI + PAD / 035\_P

cm 89x69 - h cm 96 - h seat cm 40

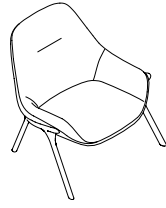

GRAN KOBI ESSENTIEL / 038

cm 89x69 - h cm 86 - h seat cm 40



GRAN KOBI POUF / 037

cm 73x42 - h cm 35

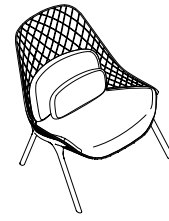

GRAN KOBI + PAD OUTDOOR / 034\_OP

cm 89x69 - h cm 96 - h cm seat 40

Seat and cushions in dry-fill, covered with Tempotest®, Alias® or ecopelle Serge Ferrari®.

Seduta e cuscini in dry-fill, rivestiti in tessuto Tempotest®, Alias® o ecopelle Serge Ferrari®.

# FINISHES

## STRUTTURA / STRUCTURE / GESTELL / STRUCTURE

Alluminio/Acciaio verniciato goffrato  
Textured lacquered aluminium/steel  
Lackiertes gerauhtes Aluminium/Stahl  
Aluminium/Acier laqué granité



A019



A011



A047



A022



A051

## SEDUTA & CUSCINO / SEAT & PAD / SITZ & KISSEN / ASSISE & COUSSIN

Tessuto  
Fabric  
Stoff  
Tissu

Alias® A  
Livign I  
Living II  
Living Outdoor

Camira® A  
Xtreme  
Urban

Kvadrat® B  
Maple  
Remix  
Tonus

Kvadrat® C  
Canvas  
Divina  
Divina Melange  
Foss  
Hallingdal 65  
Harald  
Hero  
Steelcut  
Steelcut trio  
Twill Weave

Tempotest® A



PT01

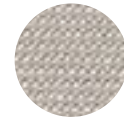

PT02

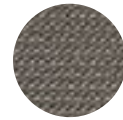

PT03

Ecopelle  
Eco-leather  
Kunstleder  
Simili cuir

Serge Ferrari®  
Stramskin® Top

Pelle Pelle Frau® SC ColorSphere®  
Pelle Frau® SC ColorSphere® leather  
Pelle Frau® SC ColorSphere® Leder  
Cuir Pelle Frau® SC ColorSphere®



B004



B020



B026



B056



B057



B080

altri colori disponibili su richiesta  
other colours available on request

Pelle Penelope Oggi® Lanilina  
Penelope Oggi® Lanilina Leather  
Penelope Oggi® Lanilina Leder  
Cuir Penelope Oggi® Lanilina



LA02



LA07



LA03



LA06

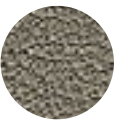

LA05



LA11



LA01

Disponibile solo per Gran Kobi Essentiel  
Available only for Gran Kobi Essentiel  
Nur für Gran Kobi Essentiel verfügbar  
Disponible uniquement pour Gran Kobi Essentiel

FOR OUTDOOR



# INDOOR

MICHELE DE LUCCHI



*Indoor* è la nuova ed elegante declinazione per interni del progetto outdoor firmato da Michele De Lucchi. La collezione per esterni *dehors*, sviluppata nel 2010, è diventata un'icona degli imbottiti di Alias. Essenziale, semplice e poetico, è stato naturale pensare ad una versione per la casa, che portasse la stessa freschezza nell'ambiente domestico.

*Indoor* ist die neue, elegante Innenbereich-Version des von Michele De Lucchi entworfenen Outdoor-Projekts. Die 2010 entwickelte Outdoor-Kollektion *Dehors* ist zu einer Ikone der Polstermöbel von Alias geworden. Essenziell, einfach und poetisch; es war naheliegend, eine Version für zu Hause zu entwickeln, die die gleiche Frische in die häusliche Umgebung bringen könnte.

*Indoor* is the new and elegant interior version of the outdoor project designed by Michele De Lucchi. The outdoor collection *dehors*, developed in 2010, has become an icon of Alias' upholstered furniture. Essential, simple, and poetic, it was natural to think of a home version that would bring the same freshness to the home environment.

*Indoor* est la nouvelle et élégante version pour l'intérieur du projet extérieur conçu par Michele De Lucchi. La collection pour l'extérieur *dehors*, développée en 2010, est devenue une icône des meubles rembourrés d'Alias. Essentiel, simple et poétique, il était naturel de penser à une version domestique qui apporterait la même fraîcheur dans l'environnement intérieur.

# INDOOR



INDOOR ARMCHAIR



INDOOR SOFA 2



INDOOR SOFA 3

## DIMENSIONS

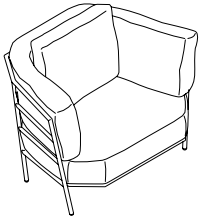

INDOOR ARMCHAIR / 376

cm 108x80 - h cm 80 - h seat cm 45

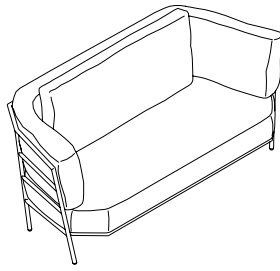

INDOOR SOFA 2 / 377

cm 172x80 - h cm 80 - h seat cm 45

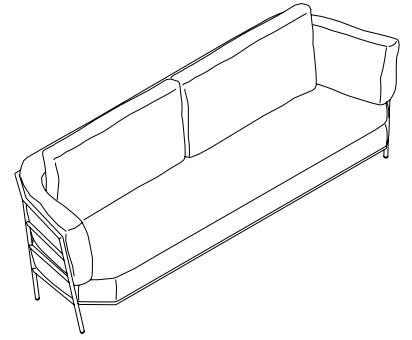

INDOOR SOFA 3 / 378

cm 253x80 - h cm 80 - h seat cm 45

## FINISHES

### STRUTTURA / STRUCTURE / GESTELL / STRUCTURE

Alluminio verniciato goffrato  
Textured lacquered aluminium  
Lackiertes gerauhtes Aluminium  
Aluminium laqué granité



A019

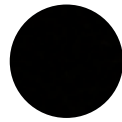

A011



A047



A022



A051

Alluminio verniciato metallizzato  
Metallic lacquered aluminium  
Aluminium metallic lackiert  
Aluminium laqué métallisé



A048



A049



A050

### SEDUTA & SCHIENALE - CUSCINO / SEAT & BACK - PAD / SITZ & RÜCKENLEHNE - KISSEN / ASSISE & DOSSIER - COUSSIN

Tessuto  
Fabric  
Stoff  
Tissu

**Alias® A**  
Livign I  
Living II

**Kvadrat® B**  
Maple  
Remix  
Tonus

**Kvadrat® C**  
Canvas  
Divina  
Divina Melange  
Foss  
Hallingdal 65  
Harald  
Hero  
Steelcut  
Steelcut trio  
Twill Weave

Pelle Pelle Frau® SC ColorSphere®  
Pelle Frau® SC ColorSphere® leather  
Pelle Frau® SC ColorSphere® Leder  
Cuir Pelle Frau® SC ColorSphere®



B004



B020



B026



B056



B057



B080

altri colori disponibili su richiesta  
other colours available on request

Pelle Penelope Oggi® Lanilina  
Penelope Oggi® Lanilina Leather  
Penelope Oggi® Lanilina Leder  
Cuir Penelope Oggi® Lanilina



LA02



LA07



LA03



LA06



LA05



LA11



LA01





# MANZÙ

PIO MANZÙ



Alias edita uno storico progetto di Pio Manzù, geniale protagonista del car design italiano degli anni '60. L'idea nasce alla GAMeC di Bergamo dove si trovano gli archivi dell'opera di Pio Manzù. L'attenzione si focalizza sul prototipo di una seduta di chiara derivazione automobilistica. La riedizione prende forma e giunge alla sua realizzazione.

Alias bringt ein historisches Projekt von Pio Manzù heraus, dem genialen Protagonisten des italienischen Car Designs der 60er Jahre. Die Idee entstand auf der GAMeC in Bergamo, wo sich die Archive der Arbeiten von Pio Manzù befinden. Und die Aufmerksamkeit lag dabei auf dem Prototyp eines Sessels, der sich ganz deutlich an der Welt der Autos orientiert.

Alias revisits historic project by Pio Manzù, the brilliant protagonist of Italian car design during the sixties. The idea materialized at the GAMeC of Bergamo where the archives of Pio Manzù's work are stored. The attention was drawn to a prototype chair clearly taking its inspiration from the automobile industry. The re-edition began and finally reached its completion.

Alias édite un projet historique signé Pio Manzù, grand nom du design automobile italien dans les années 60. L'idée a germé à la GAMeC de Bergame où les archives de l'oeuvre de Pio Manzù sont stockées. Leur attention s'est focalisée sur le prototype d'un siège très nettement inspiré de l'automobile. La réédition prend forme et entre dans sa phase de réalisation.

# MANZÙ



MANZÙ POUF / MANZÙ LOUNGE

## INTERIOR SOLUTION



### **MANZÙ / MANZÙ POUF**

FINISHES: LACQUERED ALUMINIUM (A009) PELLE FRAU® (B080)

### **HUB**

FINISHES: TEXTURED LACQUERED ALUMINIUM (A011) LACQUERED MDF (V130) FABRIC ALIAS LIVING®

### **BIPLANE XS**

FINISHES: TEXTURED LACQUERED ALUMINIUM (A011) LACQUERED MDF (V130)

## DIMENSIONS



MANZÙ LOUNGE / 090

cm 93x72 - h cm 88,5 - h seat cm 43



MANZÙ POUF / 091

cm 67x44 - h cm 37

La poltrona *manzù* è composta da scocca portante in poliuretano compatto costampato con poliuretano espanso e base a 5 razze in fusione d'alluminio verniciato e rivestimento in pelle. A completamento del progetto è stato previsto un poggiapiedi dotato di base a quattro razze del tutto coerente nel disegno e nelle proporzioni con la seduta.

The *manzù* armchair consists of a 5-star base in lacquered cast aluminium and a load-bearing shell in compact polyurethane, which is moulded together with expanded polyurethane and covered in leather. The concept has been completed by a ottoman with a 4-star base, which completely matches the seat in design and proportions.

Der Sessel *manzù* besteht aus einem Gestell mit 5-Sternauslegern aus lackiertem Aluminiumguss und einer tragenden Schale aus kompaktem Polyurethan, das zusammen mit Polyurethanschaum co-extrudiert ist und mit Leder bezogen ist. Das Konzept wurde durch einen Hocker mit Gestell mit 4-Sternausleger vervollständigt, die in Design und Proportionen mit dem Sitz komplett übereinstimmt.

Le fauteuil *manzù* est composé d'une coque porteuse en polyuréthane compact avec du polyuréthane expansé et une base à 5 branches en fonte d'aluminium laqué et revêtement en cuir. Le projet est complété par un repose-pieds doté d'une base à quatre branches tout à fait cohérente dans la conception et dans les proportions avec le siège.

## FINISHES

### STRUTTURA / STRUCTURE / GESTELL / STRUCTURE

Alluminio verniciato liscio  
Lacquered aluminium  
Lackiertes gerauhtes Aluminium  
Aluminium laqué lisse



A011

### SEDUTA & SCHIENALE / SEAT & BACK / SITZ & RÜCKENLEHNE / ASSISE & DOSSIER

Pelle Pelle Frau® SC ColorSphere®  
Leather Pelle Frau® SC ColorSphere®  
Leder Pelle Frau® SC ColorSphere®  
Cuir Pelle Frau® SC ColorSphere®



B080



# OKOME

NENDO



Dalla collaborazione con lo studio Nendo, nasce il sistema di imbottiti *okome*, una famiglia di sedute e schienali caratterizzati da ampi raggi e forme morbide e naturali che richiamano i ciottoli levigati dall'acqua. Combinando tra loro i diversi elementi, ed unendoli attraverso un sofisticato sistema di aggancio, Alias presenta diverse configurazioni, create per rispondere agli specifici utilizzi, sia delle zone di lavoro che quelle domestiche.

In Kooperation mit dem Studio Nendo entstand das Polstersystem *okome*. Eine Reihe von Sitzflächen und Rückenlehnen mit weitem Radius und weichen, natürlichen Formen, die an vom Wasser glatt polierte Kieselsteine erinnern. Durch die Kombination verschiedener Elemente mithilfe eines ausgefeilten Verbindungssystems bietet Alias unterschiedliche Konfigurationen für spezifische Verwendungszwecke, sowohl in Arbeitsbereichen als auch in Privaträumen.

From the collaboration with the Japanese studio Nendo comes *okome*, a family of seats and backs characterised by soft, rounded forms that bring to mind the natural shapes of pebbles smoothed by water. By combining the different elements together and securing them with a sophisticated hooking system, Alias obtains different configurations, specially designed to meet specific needs of the office and the home.

C'est de la collaboration avec le cabinet de design Nendo qu'est né le système d'éléments rembourrés *okome*; cette gamme d'assises et de dossiers est caractérisée par de larges rayons et des formes douces et naturelles, qui évoquent les galets polis par l'eau. En associant les différents éléments à l'aide d'un système sophistiqué d'accrochage, Alias propose des nouvelles configurations différentes, conçues pour répondre aux exigences spécifiques des zones de travail comme des espaces domestiques.

# OKOME



OKOME O02 + SMALL TABLE B



OKOME O04 + SMALL TABLE B



OKOME O06



OKOME O07



Discover all Okome configurations on [alias.design](https://www.alias.design)  
Scopri tutti le configurazioni Okome su [alias.design](https://www.alias.design)

Ogni schienale è fissato ad una seduta con un telaio in metallo verniciato.

Each backrest is fixed to the seat through a lacquered metal frame.

## OKOME ELECTRIFIED



OKOME O05

Il sistema di imbottiti *okome*, firmato dallo studio Nendo si arricchisce con i nuovi moduli elettrificati, caratterizzati da un sistema di cablaggio compatto e multifunzione perfettamente integrato.

*Okome*, capace di creare svariati scenari gestendo in modo razionale gli spazi più diversi, rappresenta la risposta di Alias al mondo delle sedute informali.

The upholstered system *okome* designed by Nendo studio is extended with the new electrified modules, characterised by a perfectly integrated, compact, multifunction cabling system. *Okome* is capable of creating the most varied scenarios managing the most diverse spaces in a rational way and it represents Alias' answer to the world of informal seats.

Das von Nendo Studio entworfenen Polstersystem *okome* wird durch die neuen elektrifizierten Module bereichert, die sich durch ein kompaktes und perfekt integriertes multifunktionales Verkabelungssystem auszeichnen. *Okome* ist in der Lage, die unterschiedlichsten Szenarien zu schaffen und die verschiedensten Räume rationell zu verwalten und stellt die Antwort von Alias auf die Welt der informellen Sitzgelegenheiten dar.

Le système de meubles rembourrés *okome*, conçu par le studio Nendo, s'enrichit de nouveaux modules électrifiés, caractérisés par un système de câblage compact et multifonction parfaitement intégré. *Okome*, capable de créer différents scénarios et de s'insérer dans les espaces les plus divers de manière rationnelle, représente la réponse d'Alias au monde des sièges informels.



## DIMENSIONS

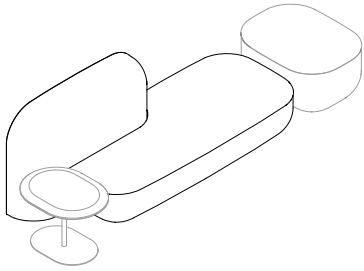

**OKOME O02 + SMALL TABLE B + POUF**  
cm 205x81 - h cm 81 - h seat cm 40

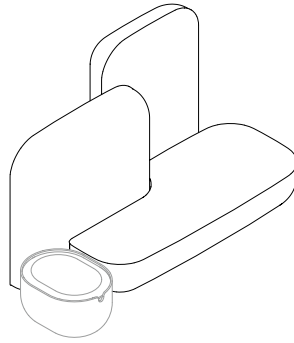

**OKOME O04 + SMALL TABLE A**  
cm 210x120 - h cm 140 - h seat cm 40

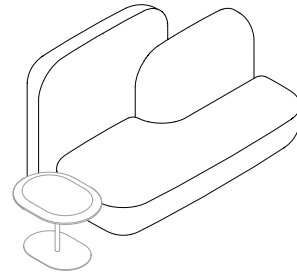

**OKOME O05 SMALL TABLE B**  
cm 185x110 - h cm 110 - h seat cm 40

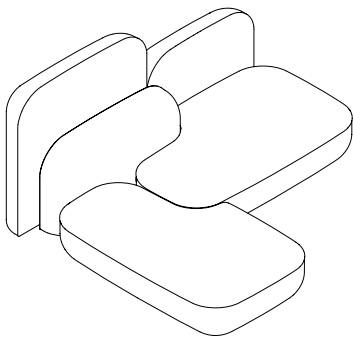

**OKOME O06**  
cm 235x220 - h cm 110 - h seat cm 40

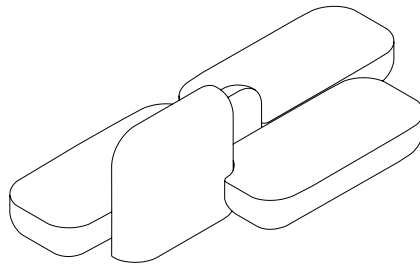

**OKOME O07**  
cm 365x165 - h cm 110 - h seat cm 40

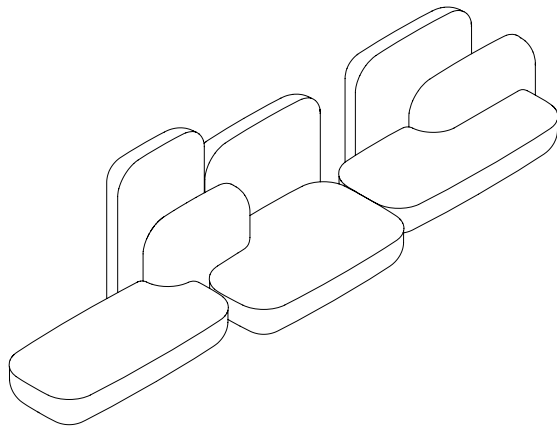

**OKOME O08**  
cm 555x130 - h cm 140 - h seat cm 40

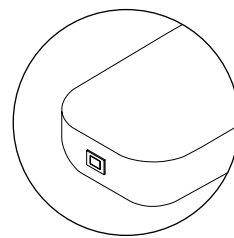

**OKOME ELECTRIFIED**  
h seat cm 41 - h wired modules cm 27

## ACCESSORIES DIMENSIONS



**OKOME SMALL TABLE A / 23A**  
cm 65x50 - h cm 36

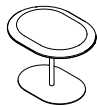

**OKOME SMALL TABLE B / 23B**  
cm 63x48 - h cm 45

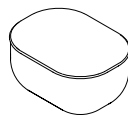

**OKOME POUF / 22A**  
cm 81x61 - h cm 44

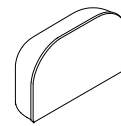

**OKOME CUSHION / 24C**  
cm 79x27 - h cm 43



## POSITION OF THE WIRED MODULES

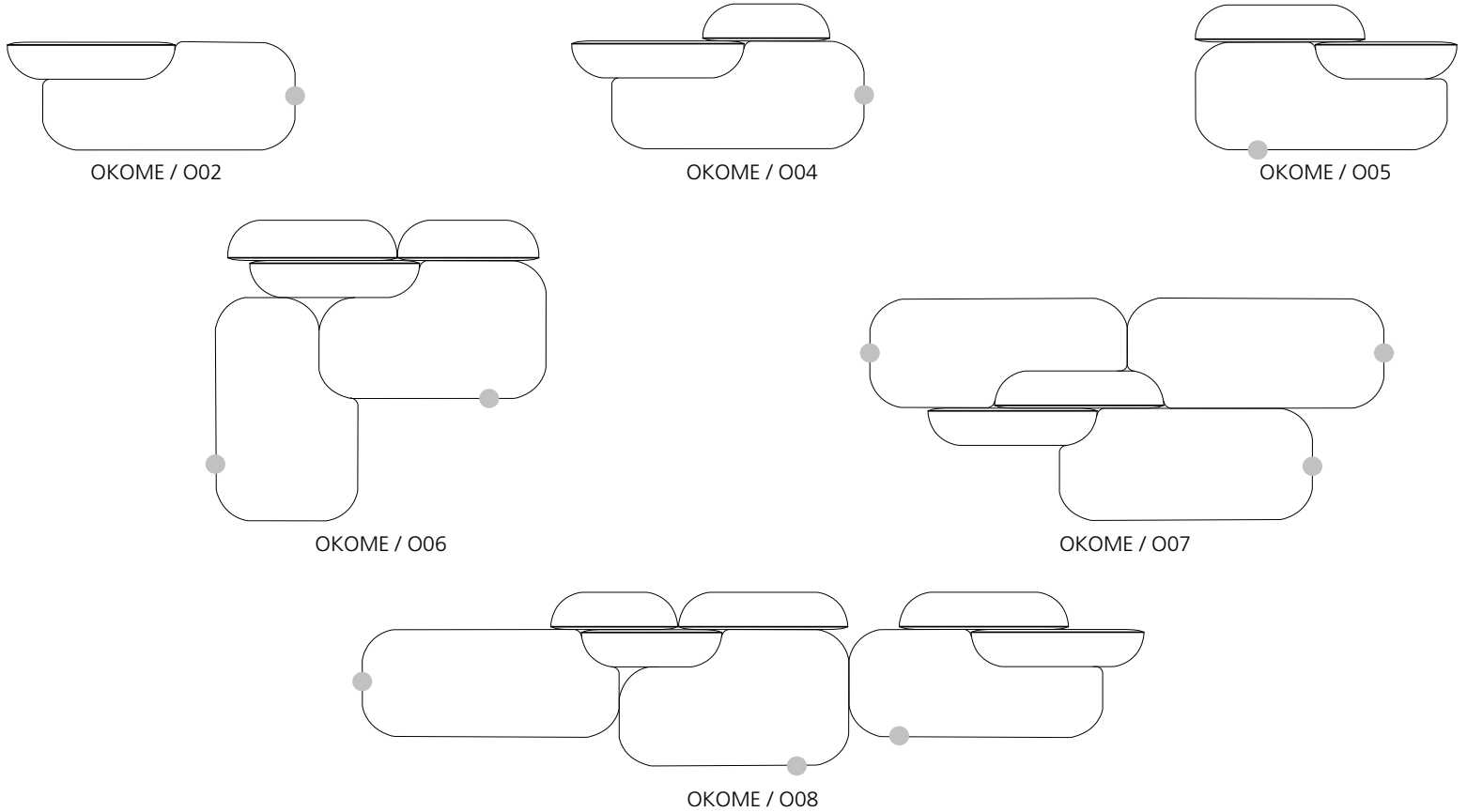

● Posizione del sistema di cablaggio compatto.  
Position of the compact cabling system.  
Position des kompakten Verkabelungssystems.  
Position du système de câblage compact.

## FINISHES

SEDUTA & SCHIENALE / SEAT & BACK / SITZ & RÜCKENLEHNE / ASSISE & DOSSIER

Tessuto  
Fabric  
Stoff  
Tissu

**Alias® A**  
Livign I  
Living II

**Camira® A**  
Xtreme  
Urban

**Kvadrat® B**  
Maple  
Remix  
Tonus

**Kvadrat® C**  
Canvas  
Divina  
Foss  
Hallingdal 65  
Hero  
Steelcut  
Steelcut trio

Ecopelle  
Eco-leather  
Kunstleder  
Simili cuir

**Stamskin Top®**  
Tempotest®

TAVOLINI / LOW TABLES / NIEDRIGE TISCHE / TABLES BASSES

Acciaio verniciato goffrato  
Textured lacquered steel  
Lackiert gerauht stahl  
Acier laqué granité

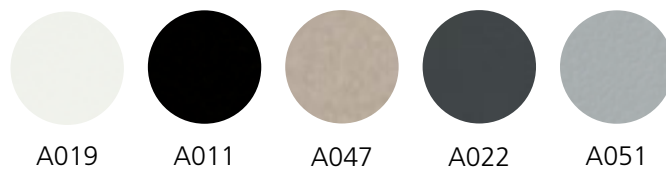

Materiale plastico  
Plastic material  
Kunststoffmaterial  
Matériau plastique

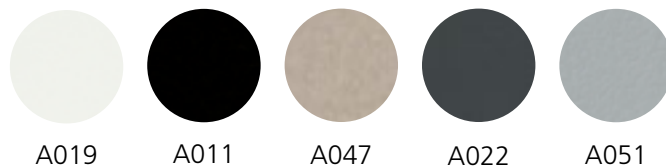



# OKOME SOFA

NENDO



Dal sistema di imbottiti *okome* nasce la collezione *okome sofa*, dalle dimensioni più raccolte, con la quale Alias si prefigge di entrare nel mondo living con un gesto fresco e raffinato, ampliando l'offerta nell'ambito soft-seating. Tutti gli elementi che compongono *okome sofa* sono caratterizzati da ampi raggi e forme morbide; combinati fra loro, ed uniti attraverso un sofisticato sistema di aggancio seduta-schiena, generano diverse configurazioni ideali per specifici utilizzi.

Aus dem Polstersystem *okome* entsteht die Sofa Kollektion *okome sofa* mit ihren kompakteren Maßen, mit der Alias mit einer frischen und raffinierten Geste in die Wohnwelt eintreten und sein Angebot im Bereich soft, seating erweitern möchte. Alle Elemente von *okome sofa* zeichnen sich durch große Radien und weiche Formen aus, die durch ein ausgeklügeltes Verbindungssystem der Rückenlehne und Sitzfläche miteinander verbunden sind und verschiedene Konfigurationen ermöglichen, die sich ideal für bestimmte Zwecke eignen.

The *okome* collection has acquired a new version of compact design: *okome sofa*, a fresh, refined addition to Alias furniture world, specially conceived for the living room area, that widens the range of soft-seating products offered. All the elements making up *okome sofa* are characterised by generous rounded lines and soft forms: assembled by means of a sophisticated cushion-to-back hooking system, they are combined in various ways to obtain a variety of configurations ideally suited for specific uses.

C'est du système de meubles rembourrés *okome* qu'est née la version *okome sofa*, aux dimensions plus compactes, avec laquelle Alias entend marquer son entrée dans l'univers du living, à travers un geste frais et raffiné, en enrichissant l'offre en matière de soft-seating. Tous les éléments qui constituent *okome sofa* sont caractérisés par de larges rayons et des formes souples. Combinés entre eux et reliés par un système sophistiqué d'ancrage assise/dossier, ils permettent de réaliser des configurations idéales pour des utilisations spécifiques.

# OKOME SOFA



OKOME SOFA ENDING 74



OKOME SOFA ENDING 74 + CUSHION



OKOME SOFA 2



OKOME SOFA ENDING 90



Discover all Okome sofa on [alias.design](https://alias.design)  
Scopri tutti gli imbottiti Okome sofa su [alias.design](https://alias.design)

## DIMENSIONS

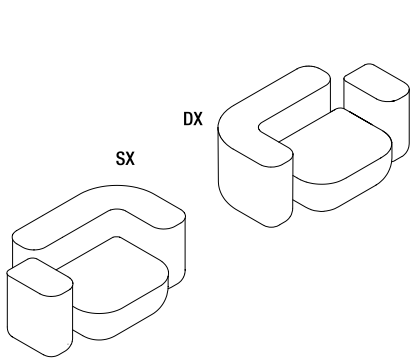

**OKOME SOFA 1 / 25A**

cm 150x100 - h cm 62 - h seat cm 37

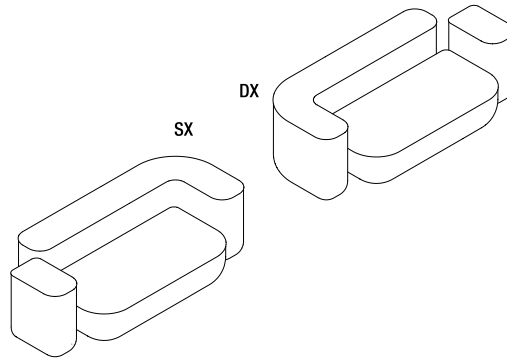

**OKOME SOFA 2 / 25B**

cm 205x100 - h cm 62 - h seat cm 37

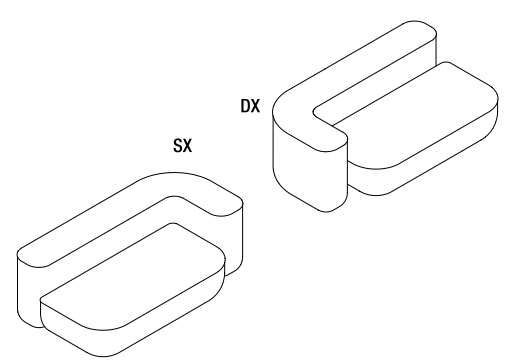

**OKOME SOFA ANGULAR 2 / 25C**

cm 175x100 - h cm 62 - h seat cm 37

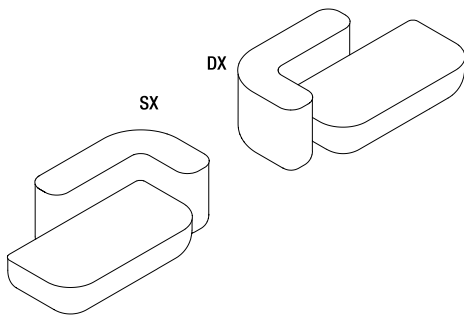

**OKOME SOFA ENDING / 25D**

cm 175x100 - h cm 62 - h seat cm 37

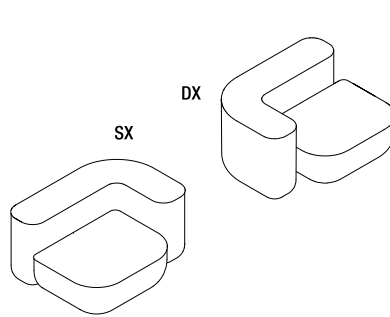

**OKOME SOFA ANGULAR 1 / 25E**

cm 120x100 - h cm 62 - h seat cm 37

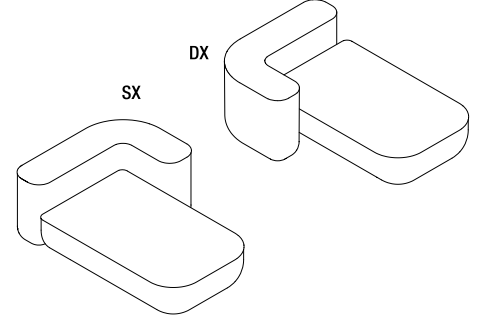

**OKOME SOFA ENDING / 25F**

cm 175x120 - h cm 62 - h seat cm 37

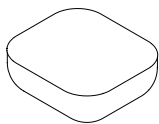

**POUF OKOME SOFA / 25G**

cm 100x90 - h seat cm 37

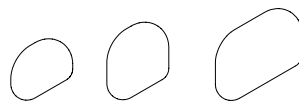

**OKOME SOFA CUSHION / 27A**

small cm 55x40 - medium cm 55x55 - large cm 80x55

## FINISHES

Rivestimenti  
Covering  
Bezug  
Revêtement

**Alias® A**  
Livign I  
Living II

**Camira® A**  
Xtreme  
Urban

**Kvadrat® B**  
Maple  
Remix  
Tonus

**Kvadrat® C**  
Canvas  
Divina  
Foss  
Hallingdal 65  
Hero  
Steelcut  
Steelcut trio

**Ecopelle / Eco-leather / Kunstleder / simil cuir**  
Stamskin Top®  
Tempotest®

**pelle / leather / leder / cuir** Pelle Frau®  
SC ColorSphere®



# TIME

ALFREDO HÄBERLI



L'antica arte degli origami, quella che fa vivere la carta attraverso minuziose piegature manuali, ha ispirato *time*, la poltrona disegnata da Alfredo Häberli per Alias. Il principio di questo progetto, infatti, si basa sulla trasformazione di un semplice foglio bidimensionale in una scocca tridimensionale. *Time* nasce da un gesto, quello che il designer compie nel dar forma a una scocca di grande equilibrio stilistico e dalle evidenti caratteristiche ergonomiche.

Die antike Kunst des Origami, die das Papier in minutiösen von Hand ausgeführten Faltbewegungen zum Leben erweckt, war die Inspiration für den Sessel *time*, den Alfredo Häberli für Alias entworfen hat. Das Prinzip dieses Projekts basiert auf der Veränderung eines einfachen zweidimensionalen Blatts in ein dreidimensionales Schale. *Time* entsteht aus der Geste des Designers beim Formen einer Struktur, die sich durch eine große stilistische Harmonie und klar erkennbare ergonomische Eigenschaften auszeichnet.

The ancient craft of origami, the art that transforms paper into a variety of shapes by folding and sculpting it, provided the inspiration for *time*, the armchair designed by Alfredo Häberli for Alias. The basic principle of this project, in fact, is the transformation of a simple twodimensional sheet into a threedimensional shell. *Time* was born of the gesture that the designer makes in giving shape to a shell characterised by great stylistic balance and unique ergonomic characteristics.

L'art ancestral de l'origami, qui fait revivre le papier à travers de minutieux pliages manuels, a inspiré *time*, le fauteuil dessiné par Alfredo Häberli pour Alias. En effet, le principe de ce projet est basé sur la transformation d'une simple feuille bidimensionnelle en une coque tridimensionnelle. *Time* est le résultat d'un geste: celui que le designer accomplit pour donner forme à une coque extrêmement équilibrée sur le plan du style et résolument ergonomique.

## TIME



TIME



TIME + PAD

Flessibile e resistente, grazie alle tecniche d'avanguardia prese in prestito dalla produzione delle tavole da snowboard, il guscio è sostenuto da un minimale telaio in metallo. Un elemento cuscino, si appoggia alla seduta per aumentarne il comfort senza modificarne l'accurata ergonomia. Con *time*, Häberli ha sfidato i più moderni processi produttivi, trovando in Alias l'interlocutore ideale per dar voce a un nuovo linguaggio contemporaneo, che riesce a far coesistere evidenti contenuti d'innovazione e una forte componente umana.

Flexible and sturdy, thanks to the leading-edge technologies borrowed from snowboard manufacturing, the shell is supported by a slim metal frame. A cushion, rested on the seat for enhanced comfort, does not alter the well-thought-out ergonomic features of the armchair. With *time*, Häberli experimented with the latest manufacturing techniques and found in Alias the ideal partner to give voice to a new, contemporary language, whereby highly innovative contents can coexist with a strong human component.

Flexibel und widerstandsfähig dank der Verwendung modernster Techniken aus der Snowboard-Produktion, sitzt die Schale in einem minimalen Metallrahmen. Ein Kisselement lehnt sich am Sitzelement an und erhöht den Komfort, ohne die genaue Ergonomie zu beeinträchtigen. Mit *time* hat Häberli die modernsten Produktionsprozesse herausgefordert und fand in Alias den idealen Ansprechpartner für die Entwicklung einer neuen, zeitgenössischen Ausdrucksweise, die klar innovativen Inhalten und einer stark menschlichen Komponente Raum gibt.

Flexible et résistante, grâce à des techniques de pointe empruntées à la fabrication des planches de snowboard, la coque est supportée par un cadre métallique minimaliste. Un élément-coussin est posé sur l'assise pour en augmenter le confort, sans pour autant en modifier l'ergonomie très étudiée.

Avec *time*, Häberli a mis au défi les processus de production les plus modernes, en trouvant chez Alias l'interlocuteur idéal pour exprimer un nouveau langage contemporain, qui parvient à faire coexister d'évidents contenus d'innovation et une forte composante humaine.



reddot winner 2020



# DIMENSIONS

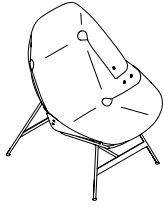

TIME / 53A



TIME PAD LARGE / 53B

cm 79x85 - h cm 103 - h seat cm 35

# FINISHES

## STRUTTURA / STRUCTURE / GESTELL / STRUCTURE

Acciaio verniciato goffrato  
Textured lacquered steel  
Lackiertes gerauhtes Sthl  
Acier laqué granité



A019



A011



A047



A022



A051

## SEDUTA & SCHIENALE / SEAT & BACK / SITZ & RÜCKENLEHNE / ASSISE & DOSSIER

Impiallacciato  
Veneered  
Furnierung  
Plaqué

Rovere naturale  
Natural oak  
Eiche natur  
Chêne naturel



RV

Rovere grigio cenere  
Ash grey oak  
Eiche aschgrau  
Chêne gris cendré



RC

## CUSCINO / PAD / KISSEN / COUSSIN

Tessuti  
Fabric  
Stoff  
Tissu

**Alias®**  
Living I  
Living II

**Kvadrat® B**  
Maple  
Remix  
Tonus

**Kvadrat® C**  
Canvas  
Divina  
Divina Melange  
Foss  
Hallingdal 65  
Harald  
Hero  
Steelcut  
Steelcut trio  
Twill weave

Pelle Pelle Frau® SC ColorSphere®  
Pelle Frau® SC ColorSphere® leather  
Pelle Frau® SC ColorSphere® leder  
Cuir Pelle Frau® SC ColorSphere®



B004



B020



B026



B056



B057



B080

altri colori disponibili su richiesta  
other colours available on request



# TRIGONO

MICHELE DE LUCCHI



Nel binomio artigianalità e tecnologia si racconta la visione di Alias, che Michele De Lucchi riesce a interpretare con abilità magistrale perché rappresenta il suo *modus operandi*. A dar forma in maniera concreta alla perfezione di tale dualismo è il progetto *trigono*, che consolida la lunghissima collaborazione fra il creativo e l'azienda. Se De Lucchi incarna il concetto di *homo faber* contemporaneo, il suo divano è un concentrato di saperi e di arti.

Die Kombination aus Handwerkskunst und Technologie erzählt die Geschichte von Alias, den Michele De Lucchi mit meisterlichem Geschick interpretiert, indem er seinen *Modus Operandi* darbietet. Das *Trigono*-Projekt, das die sehr lange Zusammenarbeit zwischen dem Designer und dem Unternehmen konsolidiert, prägt die Perfektion dieses Dualismus auf konkrete Weise. Wenn De Lucchi das Konzept des zeitgenössischen *Homo Faber* verkörpert, ist sein Sofa ein Konzentrat aus Wissen und Kunst.

The combination of craftsmanship and technology embodies the vision of Alias, which Michele De Lucchi interprets masterfully, since it matches his *modus operandi*. Tangible shape to the perfection of this dualism is given by *trigono*, a project stemming from the long-standing collaboration between Alias and the designer. If De Lucchi may be seen as the epitome of the contemporary *homo faber*, his sofa embodies the most diversified skills, arts and knowhow.

Le binôme maîtrise artisanale/technologie véhicule la philosophie d'Alias, que Michele De Lucchi parvient à interpréter magistralement car il constitue son *modus operandi*. La perfection de ce dualisme est concrètement incarnée par le projet *trigono*, qui consolide une très longue collaboration entre son designer et l'entreprise. Si De Lucchi retranscrit la notion d'*homo faber* des temps modernes, son canapé est un concentré de savoir-faire, d'art et de technique.

# TRIGONO



TRIGONO ARMCHAIR



TRIGONO SOFA 3

Un incontro di geometrie, un gioco di pieni e vuoti caratterizzano *trigono*, il divano che risulta sempre diverso a seconda del punto di vista dal quale lo si osserva. È un'architettura che si costituisce di due cavalletti laterali, una trave centrale e un sistema di cinghie su cui poggiano i cuscini: la seduta è sospesa e a sbalzo sulla struttura.

The confluence of different geometries, the interplay of solid and empty volumes characterise *trigono*, whose appearance changes constantly depending on the point of view of the observer. It is an architecture consisting of two side stands, a central beam and a system of belts supporting the cushions. The seat is suspended and cantilevered from the structure.

Eine Begegnung von Geometrien, ein Spiel von vollen und Hohlräumen zeichnen das Sofa *trigono* aus, das sich je nach Perspektive immer unterschiedlich präsentiert. Eine Architektur aus zwei Holzbocken an den Seiten, einem zentralen Träger und einem System von Riemen, auf dem die Kissen ruhen: Die Sitzfläche ist an der Struktur aufgehängt und freitragend.

L'association de géométries et les jeux de pleins et de creux font de *trigono* un canapé toujours différent en fonction de la perspective d'observation. Son architecture se compose de deux chevalets latéraux, d'une poutre centrale et d'un système de sangles sur lesquelles sont posés les coussins. L'assise est suspendue et en porte-à-faux sur la structure.

## DIMENSIONS

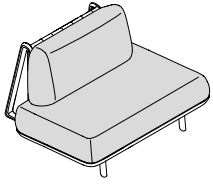

TRIGONO ARMCHAIR / D10

cm 110x115 - h cm 80 - h seat cm 41

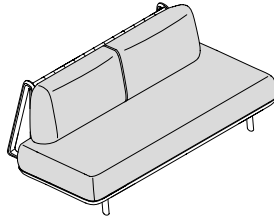

TRIGONO SOFA 2 / D20

cm 190x115 - h cm 80 - h seat cm 41

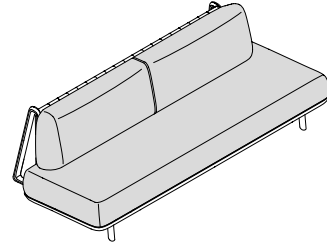

TRIGONO SOFA 3 / D30

cm 245x115 - h cm 80 - h seat cm 41

## FINISHES

### STRUTTURA / STRUCTURE / GESTELL / STRUCTURE

Essenze  
Wood  
Holzarten  
Bois

Rovere naturale  
Natural oak  
Eiche natur  
Chêne naturel

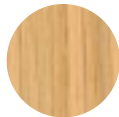

RV

Rovere grigio cenere  
Ash grey oak  
Eiche aschgrau  
Chêne gris cendré



RC

### SEDUTA & SCHIENALE / SEAT & BACK / SITZ & RÜCKENLEHNE / ASSISE & DOSSIER

Tessuti  
Fabric  
Stoff  
Tissu

**Alias®**  
Living I  
Living II

**Kvadrat® B**  
Maple  
Remix  
Tonus

**Kvadrat® C**  
Canvas  
Divina  
Divina Melange  
Foss  
Hallingdal 65  
Harald  
Hero  
Steelcut  
Steelcut trio  
Twill weave

Pelle Pelle Frau® SC ColorSphere®  
Pelle Frau® SC ColorSphere® leather  
Pelle Frau® SC ColorSphere® leder  
Cuir Pelle Frau® SC ColorSphere®



B004



B020



B026



B056



B057

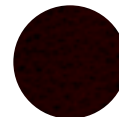

B080

altri colori disponibili su richiesta  
other colours available on request

Pelle Penelope Oggi® Lanilina  
Penelope Oggi® Lanilina Leather  
Penelope Oggi® Lanilina Leder  
Cuir Penelope Oggi® Lanilina



LA02



LA07



LA03



LA06

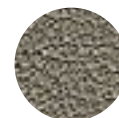

LA05



LA11

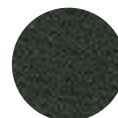

LA01



# TWELVE

PEARSONLLOYD



Il duo britannico PearsonLloyd firma *twelve*, un sistema di imbottiti, dalle dimensioni generose che assicurano un elevato comfort.

Una rivisitazione del divano domestico in chiave Alias, *twelve* è una famiglia costituita da poltrona, divano a due e tre posti, chaise longue ed elementi angolari, che possono essere combinati in diverse maniere creando ogni volta configurazioni diverse.

Das britische Duo PearsonLloyd signiert *twelve*, ein großzügig dimensioniertes Polstersystem, das hohen Komfort anbietet. *Twelve* ist eine Neuinterpretation des Haussofas im Stil von Alias und die Kollektion besteht aus einem Sessel, zwei- oder drei-Sitzer Sofa, Chaise longue und Eckelementen. Diese können auf verschiedenen Weisen miteinander kombiniert werden und somit entstehen zahlreiche Konfigurationen.

The British duo PearsonLloyd signs *twelve*, a generously sized upholstered furniture system that ensures high comfort.

*Twelve* is a reinterpretation of the domestic sofa from Alias perspective; this collection consists of an armchair, a two- or three-seater sofa, chaise longue and corner elements. These can be combined in various ways to create different configurations.

Le duo britannique PearsonLloyd présente *twelve*, un système d'éléments rembourrés aux dimensions généreuses, qui assurent un confort élevé. Une réinterprétation du canapé domestique selon le style Alias, *twelve* est une famille composée de fauteuil, canapé à deux et trois places, chaise longue et éléments angulaires, qui peuvent être combinés de différentes manières en créant à chaque fois des configurations différentes.

# TWELVE



TWELVE ARMCHAIR



TWELVE SOFA 2



TWELVE SOFA 3



TWELVE ANGULAR



TWELVE DOMEUSE



## DIMENSIONS

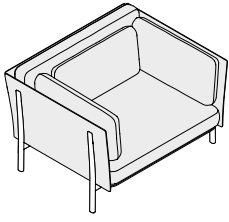

TWELVE ARMCHAIR / 880

cm 118x98 - h cm 77 - h seat cm 45

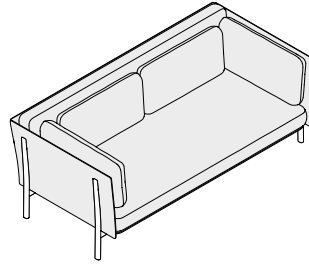

TWELVE SOFA 2 / 881

cm 196x98 - h cm 77 - h seat cm 45

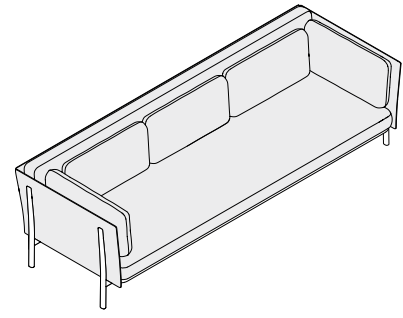

TWELVE SOFA 3 / 882

cm 270x98 - h cm 77 - h seat cm 45

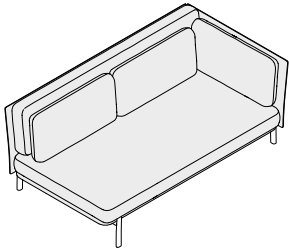

TWELVE ANGULAR / 883

cm 173x98 - h cm 77 - h seat cm 45

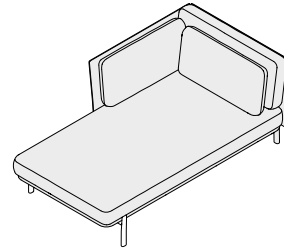
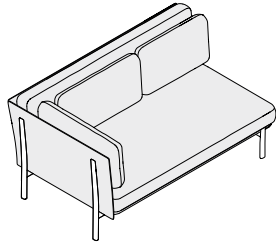

TWELVE DORMEUSE / 884

cm 173x98 - h cm 77 - h seat cm 45

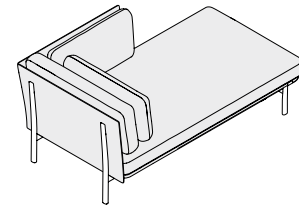

## FINISHES

### STRUTTURA / STRUCTURE / GESTELL / STRUCTURE

Alluminio lucidato  
Polished aluminium  
Aluminium poliert  
Aluminium poli



AB

Alluminio verniciato goffrato  
Textured lacquered aluminium  
Lackiertes gerauhtes aluminium  
Aluminium laqué granité



A019



A011



A047



A022



A051

### SEDUTA & SCHIENALE / SEAT & BACK / SITZ & RÜCKENLEHNE / ASSISE & DOSSIER

Tessuto  
Fabric  
Stoff  
Tissu

**Alias® A**  
Livign I  
Living II

**Camira® A**  
Xtreme  
Urban

**Kvadrat® B**  
Maple  
Remix  
Tonus

**Kvadrat® C**  
Canvas  
Divina  
Foss  
Hallingdal 65  
Hero  
Steelcut  
Steelcut trio

Pelle Pelle Frau® SC ColorSphere®  
Pelle Frau® SC ColorSphere® leather  
Pelle Frau® SC ColorSphere® Leder  
Cuir Pelle Frau® SC ColorSphere®



B004



B020



B026



B056



B057

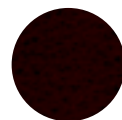

B080

altri colori disponibili su richiesta  
other colours available on request



# VINA

PATRICK NORGUET



Con l'intento di creare un prodotto pratico, confortevole ed elegante, Patrick Norguet progetta *vina*, un divano il cui design riassume e spiega la sua genesi. In *vina* la struttura è sinuosa e induce il progetto: disegnata e pensata dall'esterno, supporta naturalmente le zone di comfort. Fedele alla filosofia di Alias, dove le geometrie vengono ridotte a favore dei materiali portati al limite, questa famiglia si caratterizza per un'anima che lascia un'impressione di leggerezza e semplicità unendo comfort ed eleganza.

Mit dem Ziel, ein praktisches, komfortables und elegantes Produkt zu schaffen, entwirft Patrick Norguet *vina*, ein Sofa, dessen Design seine eigenen Entstehung zusammenfasst und erklärt. In *vina* die gewundene Struktur induziert das Projekt: Von außen entworfen und durchdacht, unterstützt es natürlich die Komfortzonen. Getreu der Philosophie von Alias, wo Geometrien zugunsten von ans Limit gebrachten Materialien reduziert werden, zeichnet sich diese Familie durch eine Seele aus, die einen Eindruck von Leichtigkeit und Einfachheit hinterlässt und Komfort und Eleganz verbindet.

With a view to creating a practical, comfortable and elegant product, Patrick Norguet designs *vina* a sofa whose appearance summarises and explains its genesis. In *vina* the sinuous structure generates the project: designed and conceived from the outside, it naturally supports the comfort zones. Loyal to Alias' philosophy, whereby geometries are reduced in favour of materials pared down to the minimum, this family of padded furniture is characterised by a spirit that gets across an impression of lightness and simplicity, blending together comfort and elegance.

En vue de créer un produit pratique, confortable et élégant, Patrick Norguet a conçu *vina*, un canapé dont le design résume et explique sa genèse. En *vina* c'est de la structure sinueuse que naît le projet: dessinée et pensée depuis l'extérieur, elle supporte tout naturellement les zones de confort. Fidèle à la philosophie de Alias, pour laquelle les géométries doivent laisser place aux matériaux, déclinés jusqu'à leurs limites, cette famille est caractérisée par une volonté de procurer une sensation de légèreté et de simplicité, alliant confort et élégance.

# VINA



VINA ARMCHAIR



VINA SOFA

Dal punto di vista produttivo *vina* è composto da un telaio, realizzato assemblando diversi elementi in alluminio estruso, che esaltano la fluidità delle forme, e da cinghie elastiche, che aumentano il comfort della seduta.

Una serie di cuscini, dal design affilato e curato, che non lascia al caso nessuna geometria, sono realizzati in poliuretano espanso a densità differenziata e imbottitura in piuma d'oca. Rivestiti in tessuto o pelle, sono specifici per la seduta, lo schienale ed i braccioli.

From the production standpoint, *vina* is comprised of a frame, obtained by assembling various extruded aluminium elements that exalt the smoothness of the forms, and elastic belts that enhance the degree of comfort offered by the seat.

The cushions - a series of slender, carefully designed elements, which leave no geometry to chance - are made of diversified density polyurethane foam and are padded with goose feather. Upholstered with fabric or leather, the cushions are specifically designed for the seat, the back and the arms of the sofa.

Produktionstechnisch handelt es sich bei *vina* um einen Rahmen aus unterschiedlichen Elementen aus extrudiertem Aluminium, die die Fluidität der Formen hervorheben, sowie aus elastischen Riemen, die einen großen Sitzkomfort bieten. Die schlanken, ausgefeilten Kissen, die die Geometrie nicht dem Zufall überlassen, bestehen aus Schaumpolyurethan unterschiedlicher Dichte und sind gepolstert mit Gänsedaunenpolster. Die Rücken- und Armlehnen haben einen Bezug aus Stoff oder Leder und eignen sie sich perfekt zum bequemem Sitzen.

*Vina* se compose d'une structure obtenue par l'assemblage de différents éléments en aluminium extrudé qui mettent en valeur la fluidité des formes, et de sangles élastiques qui améliorent le confort de l'assise. Les coussins, au design épuré et soigné, dont les géométries ne sont jamais aléatoires, sont réalisés en polyuréthane expansé à densité variable et rembourrage en duvet d'oie. Habillés de tissu ou de cuir, les coussins sont destinés à l'assise, au dossier et aux accoudoirs.

## DIMENSIONS



VINA ARMCHAIR / V01

cm 118x94 - h cm 74 - h seat cm 41

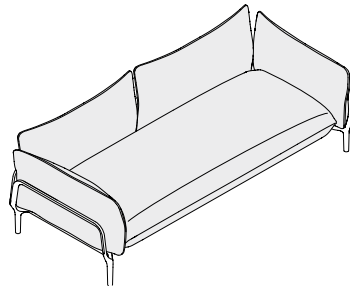

VINA SOFA / V02

cm 221x94 - h cm 74 - h seat cm 41

## FINISHES

### STRUTTURA / STRUCTURE / GESTELL / STRUCTURE

Alluminio lucidato  
Polished aluminium  
Aluminium poliert  
Aluminium poli



AB

Alluminio verniciato goffrato  
Textured lacquered aluminium  
Lackiertes gerauhtes Aluminium  
Aluminium laqué granité



A019



A011



A047



A022



A051

### SEDUTA & SCHIENALE / SEAT & BACK / SITZ & RÜCKENLEHNE / ASSISE & DOSSIER

Tessuti  
Fabric  
Stoff  
Tissu

Alias®  
Living I  
Living II

Camira®  
Xtreme  
Urban

Kvadrat® B  
Maple  
Remix  
Tonus

Kvadrat® C  
Canvas  
Divina  
Divina Melange  
Foss  
Hallingdal 65  
Harald  
Hero  
Steelcut  
Steelcut trio  
Twill weave

Stamskin Top®  
Tempotest®

Pelle Pelle Frau® SC ColorSphere®  
Pelle Frau® SC ColorSphere® leather  
Pelle Frau® SC ColorSphere® leder  
Cuir Pelle Frau® SC ColorSphere®



B004



B020



B026



B056



B057



B080

altri colori disponibili su richiesta  
other colours available on request

Pelle Penelope Oggi® Lanilina  
Penelope Oggi® Lanilina Leather  
Penelope Oggi® Lanilina Leder  
Cuir Penelope Oggi® Lanilina



LA02



LA07



LA03



LA06



LA05



LA11



LA01



# VIOLON

PAOLO RIZZATTO



Paolo Rizzatto, designer che ha arricchito fin dalle origini il catalogo di Alias con prodotti colti e raffinati, porta in collezione *violon*, una elegante poltrona lounge dotata di una scocca elastica che adattandosi al corpo conferisce un grande comfort. Il progetto nasce attorno all'idea di utilizzare un materiale morbido e strutturale, il cuoio, rivisto in chiave tecnologica. Tradizione ed innovazione si fondono in *violon* che dimostra come la qualità progettuale del design di Alias non abbia tempo ed età.

Paolo Rizzatto, ein Designer, der Alias-Katalog von Anfang an mit gehobenen und raffinierten Produkten bereichert hat, ergänzt die Kollektion um das Modell *violon*. Der Sessel ist mit einer flexiblen Schale ausgestattet, die sich dem Körper anpasst und großen Komfort bietet. Das Projekt entstand aus der Idee heraus, ein weiches und strukturelles Material zu verwenden, nämlich Kernleder, das von Alias technologisch überarbeitet wird. Tradition und Innovation vereinen sich in diesem Projekt, das beweist, dass die Qualität des Alias-Designs zeitlos und alterslos ist.

Paolo Rizzatto, a designer who has enriched Alias catalogue from its very beginning with refined products, introduces in the collection *violon*, an armchair with a flexible shell that adapts to the body and gives great comfort. The project was born around the idea of using a soft and structural material, hide, revised in a technological key. Tradition and innovation come together in this project that demonstrates how the design quality of Alias is timeless and ageless.

Paolo Rizzatto, le designer qui a enrichi le catalogue Alias avec des produits cultivés et raffinés depuis ses débuts, apporte à la collection le modèle *violon*, un fauteuil équipé d'une coque élastique qui s'adapte au corps et offre un maximum de confort. Le projet est né de l'idée d'utiliser un matériau à la fois souple et structurel, le cuir, réinterprété à travers le prisme technologique. Tradition et innovation se fondent dans *violon* qui montre que la qualité conceptuelle du design d'Alias n'a pas de temps et d'âge.

## VIOLON



---

VIOLON



---

VIOLON SOFT / POUF

La scocca di *violon*, struttura e seduta al tempo stesso, è costruita in modo da potersi deformare elasticamente per poi tornare nella forma originaria, accogliendo "in un abbraccio" chi si siede. Una poltrona dal comfort straordinario studiata appositamente per rilassarsi sia a casa che nelle aree lounge.

*Violon* shell, structure and seat at the same time, is constructed in such a way that it can be elastically deformed and then return to its original form, enveloping those who sit down "in an embrace". A chair of extraordinary comfort specifically designed for relaxing both at home and in lounge areas.

Die Schale von *violon* ist gleichzeitig Struktur und Sitzfläche. Sie ist so konstruiert, dass sie sich elastisch verformen und wieder in ihre ursprüngliche Form zurückkehren kann, damit sie den Sitzenden „umarmt“. Ein Sessel mit außergewöhnlichem Komfort, der speziell für die Entspannung zu Hause und in Lounge Bereichen entwickelt wurde.

La coque de *violon*, à la fois structure et assise, est réalisée de manière à se déformer élastiquement et à reprendre sa forme initiale, en accueillant ceux qui s'assoient «dans une étreinte». Un fauteuil qui offre un confort extraordinaire, conçu spécialement pour les moments de détente à la maison et dans les salons lounge.



# DIMENSIONS

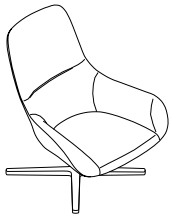

VIOLON SOFT / R01

cm 88x80 - h cm 93 - h seat cm 40



VIOLON / R02

cm 88x76 - h cm 92 - h seat cm 44

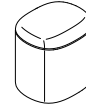

VIOLON POUF / R03

cm 45x36 - h cm 42

# FINISHES

## STRUTTURA / STRUCTURE / GESTELL / STRUCTURE

Alluminio verniciato goffrato  
Textured lacquered aluminium  
Lackiertes gerauhtes Aluminium  
Aluminium laqué granité

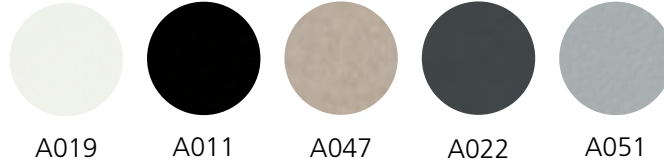

Alluminio verniciato metallizzato  
Metallic lacquered aluminium  
Aluminium Metallic lackiert  
Aluminium laqué métallise

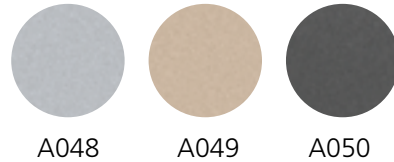

## SEDUTA & SCHIENALE / SEAT & BACK / SITZ & RÜCKENLEHNE / ASSISE & DOSSIER

Cuoio  
Hide  
Kernleder  
Cuir sellier



Tessuti  
Fabric  
Stoff  
Tissu

**Alias®**  
Living I / II  
  
**Camira®**  
Xtreme  
Urban

**Kvadrat® B**  
Maple  
Remix  
Tonus

**Kvadrat® C**  
Canvas  
Divina  
Divina Melange  
Foss  
Hallingdal 65  
Harald

**Kvadrat® C**  
Hero  
Steelcut  
Steelcut trio  
Twill weave

Pelle Pelle Frau® SC ColorSphere®  
Pelle Frau® SC ColorSphere® leather  
Pelle Frau® SC ColorSphere® leder  
Cuir Pelle Frau® SC ColorSphere®



altri colori disponibili su richiesta  
other colours available on request

Pelle Penelope Oggi® Lanilina  
Penelope Oggi® Lanilina Leather  
Penelope Oggi® Lanilina Leder  
Cuir Penelope Oggi® Lanilina





# BEDS

LETTI • BETTEN • LITS

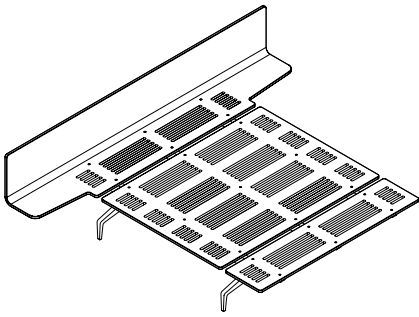

---

LEGNOLETTO  
pag. 282

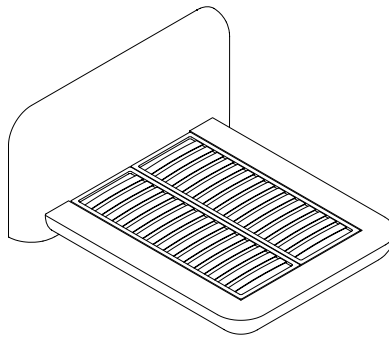

---

OKOME BED  
pag. 288



# LEGNOLETTO

ALFREDO HÄBERLI



Le gambe in alluminio pressofuso a sostegno della struttura sono l'elemento comune della collezione *legnoletto*. I letti hanno una struttura in legno massello verniciata in vari colori. Un sistema di letti articolato e completo che arreda con eleganza la stanza.

Die Beine aus Aluminiumdruckguss sind das gemeinsame Element der Kollektion *legnoletto*. Die Struktur der Betten besteht aus Massivholz lackiert in verschiedenen Farben. Ein modulares und komplettes Bettsystem, das mit Eleganz das Zimmer einrichtet.

The legs in die-cast aluminium supporting the structure are the common feature of the *legnoletto* collection. The beds have a frame made of solid wood lacquered in various colours. A complete and articulate system of beds that furnish any room with elegance.

Les pieds en aluminium moulé sous pression, qui soutiennent la structure, sont les éléments communes de la collection *legnoletto*. Lits avec structure en bois massif laquée en différentes couleurs. Un système des lits articulé et complet qui meuble avec élégance la pièce.

# LEGNOLETTO

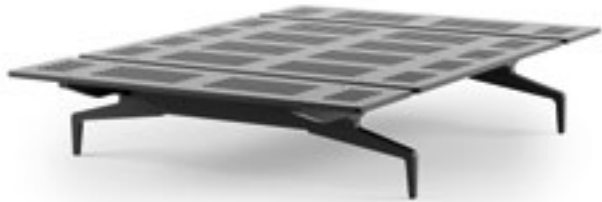

LEGNOLETTO LL0

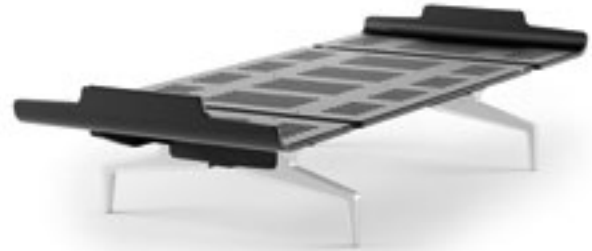

LEGNOLETTO LL1



LEGNOLETTO LL3



LEGNOLETTO LL4

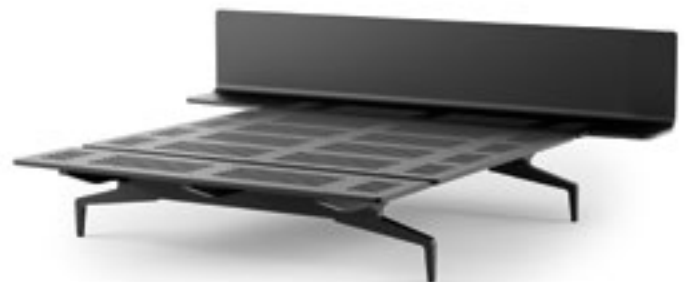

LEGNOLETTO LL8



Discover all Legnoletto beds on [alias.design](https://alias.design)  
Scopri tutti i letti Legnoletto su [alias.design](https://alias.design)

**LEGNOLETTO**  
ALUMINIUM (AB)  
POLISHED MATT LACQUERED (V001)



## DIMENSIONS

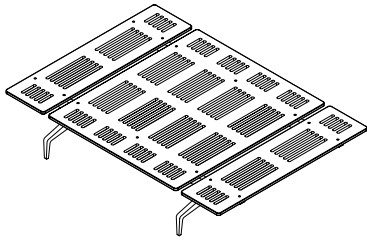

LEGNOLETTO LL0

cm 200x120/140 - h cm 37

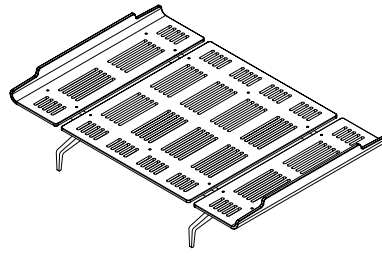

LEGNOLETTO LL1

cm 212x90/120/140 - h cm 49 - h seat cm 37

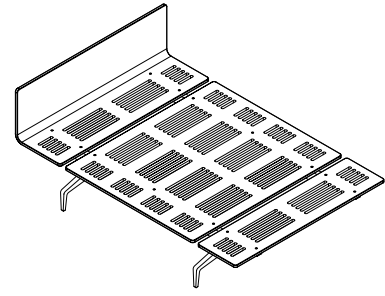

LEGNOLETTO LL3

cm 206x90/120/140/160/180 - h cm 77 - h seat cm 37

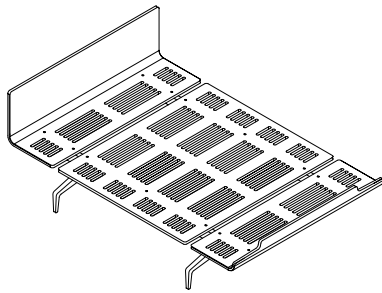

LEGNOLETTO LL4

cm 212x90/120/140/160/180 - h cm 77 - h seat cm 37

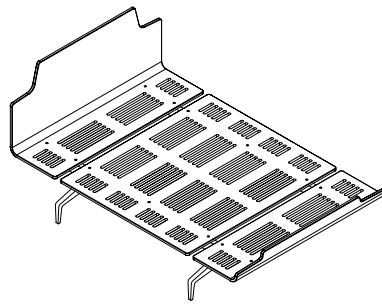

LEGNOLETTO LL7

cm 212x90/120/140/160/180 - h cm 97 - h seat cm 37

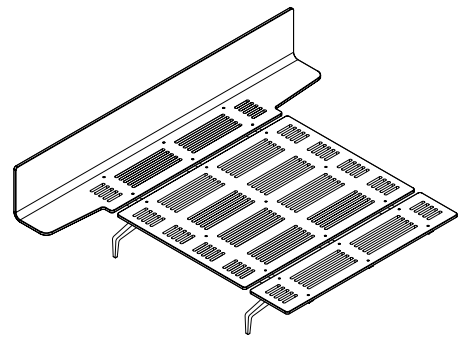

LEGNOLETTO LL8

cm 206x160/180 - h cm 77 - h seat cm 37

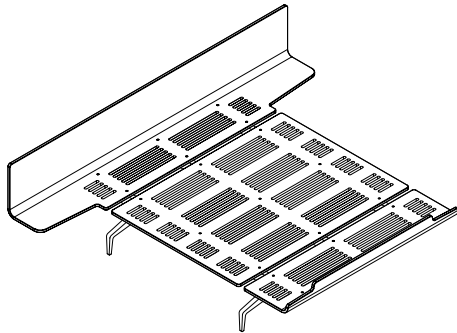

LEGNOLETTO LL9

cm 212x160/180 - h cm 77 - h seat cm 37

Lineare e contemporaneo, *legnoletto* è disponibile in varie misure e modelli, con e senza testiera o mensole comodino. Le diverse tipologie si ottengono da una serie di elementi modulari componibili secondo le varie esigenze.

Linear and contemporary, *legnoletto* is available in various sizes and models, with or without headboard and bedside shelves. Different configurations are obtained through a range of modular elements that can be organised to meet different needs.

Linear und zeitgenössisch ist *legnoletto* in unterschiedlichen Größen und Varianten erhältlich, mit oder ohne Kopfteil oder Nachttischen. Je nach Bedarf werden die verschiedenen modularen Elementen zusammengestellt und somit entstehen zahlreichen Bett-Typologien.

Sobre et moderne, *legnoletto* est disponible en plusieurs dimensions et en différent modèles, avec et sans tête de lit ou tablettes de chevet. Ses éléments modulaires composables permettent de répondre à des besoins différents.



# OVERVIEW

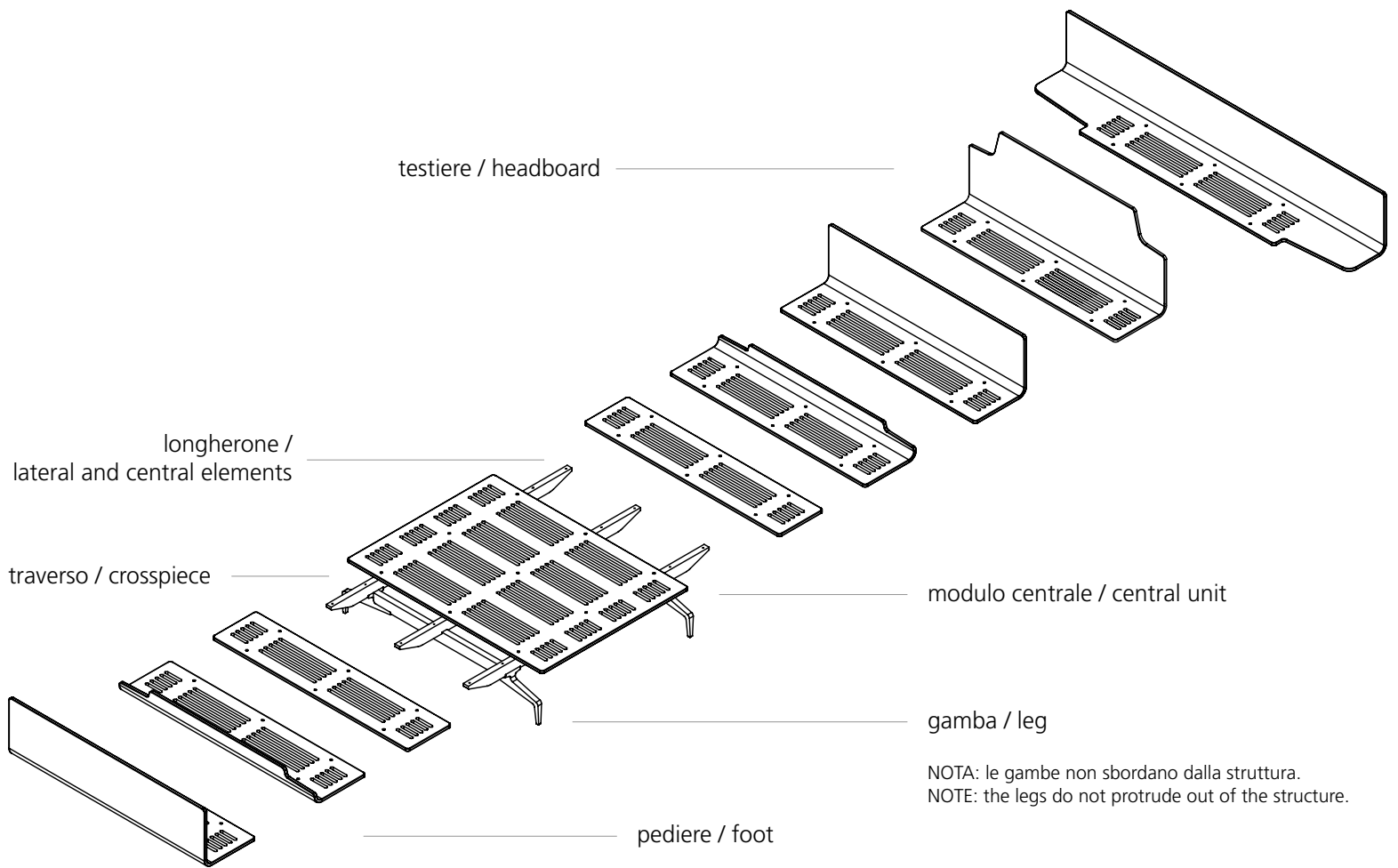

# FINISHES

## GAMBE / LEGS / FÜBE / PIEDS

Alluminio lucidato  
Polished aluminium  
Aluminium poliert  
Aluminium poli



AB

## STRUTTURA & GAMBE / STRUCTURE & LEGS / GESTELL & FÜBE / STRUCTURE & PIEDS

Verniciatura opaca  
Matt lacquer  
Mattlack  
Laquage opaque



V001



V130



V003



V007



V110



# OKOME BED

NENDO



*Okome bed*, un letto imbottito composto da una struttura solida e leggera ed una testiera caratterizzata da ampi raggi e forme morbide e naturali che richiama la collezione di divani. Il risultato è un oggetto morbido, un volume compatto: struttura e testiera sono realizzate in legno multistrato con imbottitura in poliuretano espanso che ne esalta le forme.

*Okome bed* ist ein gepolstertes Bett mit einer soliden leichten Struktur und einem Kopfteil, das durch großzügige Kurven sowie weiche und natürliche Formen charakterisiert ist, die an die Sofa Kollektion erinnern.

Das Ergebnis ist ein Objekt mit weichen Formen und einem kompakten Volumen: Struktur und Kopfteil sind aus mehrschichtigem Holz und einer Polsterung aus Polyurethanschaum, das die Formen erhebt.

*Okome bed*, a padded bed composed of a solid light-weight structure and a headboard characterised by gentle curves and soft, natural shapes that recall the collection of sofas. The result is a soft object with a compact volume: the structure and the headboard are both made of multi-layered wood and are padded with polyurethane foam that exalts their shapes.

*Okome bed*: lit rembourré, constitué d'une structure solide et légère à la fois et d'une tête, caractérisée par de larges rayons, dont les formes souples et naturelles ne sont pas sans rappeler la collection de canapés.

Il s'agit d'un objet souple, aux volumes compacts: la structure et la tête de lit sont réalisées en bois multicouche, avec un rembourrage en polyuréthane expansé, qui met en valeur les galbes.

# OKOME BED



## DIMENSIONS

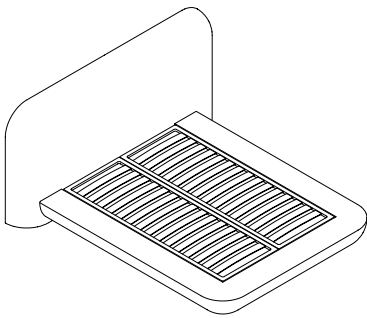

OKOME BED 28A

cm 244x235/255/275 - h cm 110 - h seat cm 26



## FINISHES

Tessuti  
Fabric  
Stoff  
Tissu

**Alias®**  
Living I  
Living II

**Kvadrat® B**  
Maple  
Remix  
Tonus

**Kvadrat® C**  
Canvas  
Divina  
Foss  
Hallingdal 65  
Hero  
Steelcut  
Steelcut trio

**Camira®**  
Xtreme  
Urban

Ecopelle  
Eco-leather  
Kunstleder  
Simili cuir

**Stamskin Top®**  
Tempotest®

Pelle Pelle Frau® SC ColorSphere®  
Pelle Frau® SC ColorSphere® leather  
Pelle Frau® SC ColorSphere® leder  
Cuir Pelle Frau® SC ColorSphere®

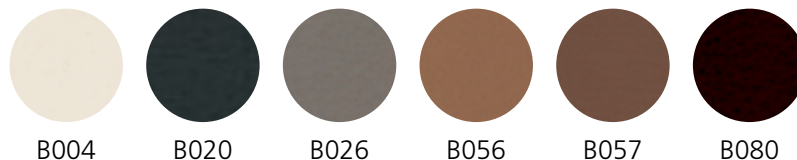

altri colori disponibili su richiesta  
other colours available on request

# INTERIOR SOLUTIONS



**OKOME BED**

FINISHES: FABRIC KAVDRAT®

**OKOME CONTAINER**

FINISHES: TEXTURED LACQUERED STEEL (A047) PLASTIC MATERIAL (A047)

**LAYOUT SECRÉTAIRE**

FINISHES: TEXTURED LACQUERED ALUMINIUM (A011) WOOD (RV)

**YOUNG LADY**

FINISHES: ALUMINIUM (AB) WOOD (TFRN)



**OKOME BED**

FINISHES: FABRIC KAVDRAT®

**OKOME CONTAINER**

FINISHES: TEXTURED LACQUERED STEEL (A019) PLASTIC MATERIAL (A019)

**DRY**

FINISHES: TEXTURED LACQUERED ALUMINIUM (A019) GLASS (VTT)

**ELLE**

FINISHES: TEXTURED LACQUERED ALUMINIUM (A019) POLYURETHANE TECH® (PH02)



# MODULAR SYSTEMS / ACCESSORIES

SISTEMI MODULARI / COMPLEMENTI • MODULARE SYSTEME / BEISTELLMÖBEL • SYSTÈME MODULAIRES / ACCESSOIRES

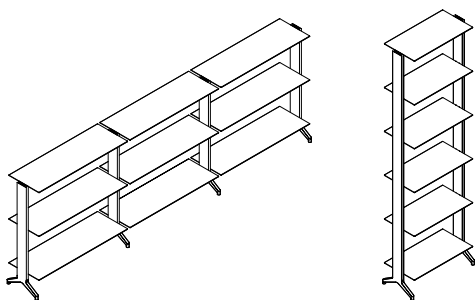

ALINE  
pag. 292

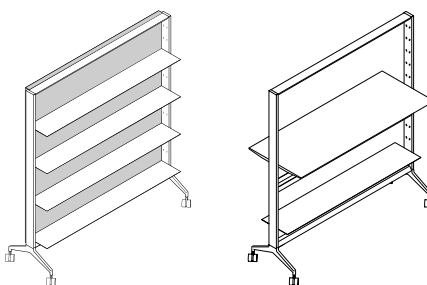

ALINE WORK  
pag. 300

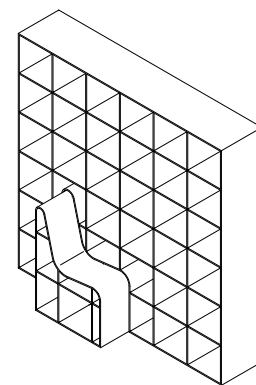

BOOKCHAIR  
pag. 306

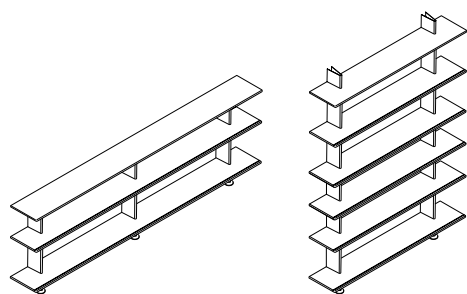

HUB  
pag. 310

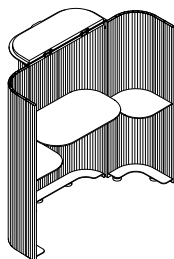

LAYOUT  
pag. 316

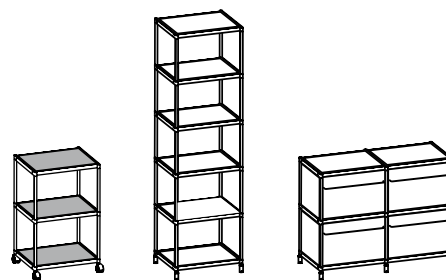

SEC  
pag. 320

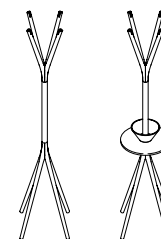

TO'TAIME  
pag. 326





# ALINE

DANTE BONUCCELLI



*Aline.* Lineare. Leggera. Di rigorosa eleganza. La libreria come quinta discreta di spazi domestici o di lavoro. È il progetto di Dante Bonuccelli per Alias. L'architetto e designer di origine argentina immagina una struttura sottile e pulitissima. In alluminio estruso verniciato nei toni neutri del bianco, del grigio grafite o grigio chiaro, sabbia, nero - lascia ai libri il compito di arredare gli spazi.

*Aline.* Linear, leicht, mit schlichter Eleganz. Das Bücherregal als diskrete Kulisse für Heim und Büroumgebungen. Ein Projekt von Dante Bonuccelli für Alias: Der argentinischer Architekt und Designer präsentiert eine feine Struktur mit puren klaren Linien. Das extrudierte Aluminium, lackiert in den neutralen Tönen weiß, graphit-grau hellgrau, sand, schwarz, lässt den Büchern die Möglichkeit den Raum zu gestalten.

*Aline.* Linear, light, and rigorously elegant. This bookcase can be used to create a subtle partition for home or office environments it has been. Designed for Alias by Dante Bonuccelli, an architect and designer of Argentine origin. He conceived a slim and very clean-cut structure, made of extruded lacquered aluminium in neutral shades of white, graphite grey or light grey, sand, black, thus letting the books furnish the space.

*Aline.* Linéaire. Légère. D'une élégance impeccable. Une bibliothèque, ou plutôt une coulisse discrète pour espaces domestiques ou professionnels. Tel est le projet de Dante Bonuccelli pour Alias. L'architecte et designer d'origine argentine imagine une structure fine et ultra sobre. En aluminium extrudé laqué dans les tons neutres blanc, gris graphite, gris clair, sable ou noir, elle laisse aux livres le soin de décorer l'espace.

# ALINE EXAMPLE CONFIGURATIONS



For other models see our website. / *Per altri modelli consultare il nostro sito.*

**Set up ALINE on "Aline Planner" on [alias.design](http://alias.design) / Configura ALINE su "Aline Planner" su [alias.design](http://alias.design)**

## ALINE EXAMPLE CONFIGURATIONS

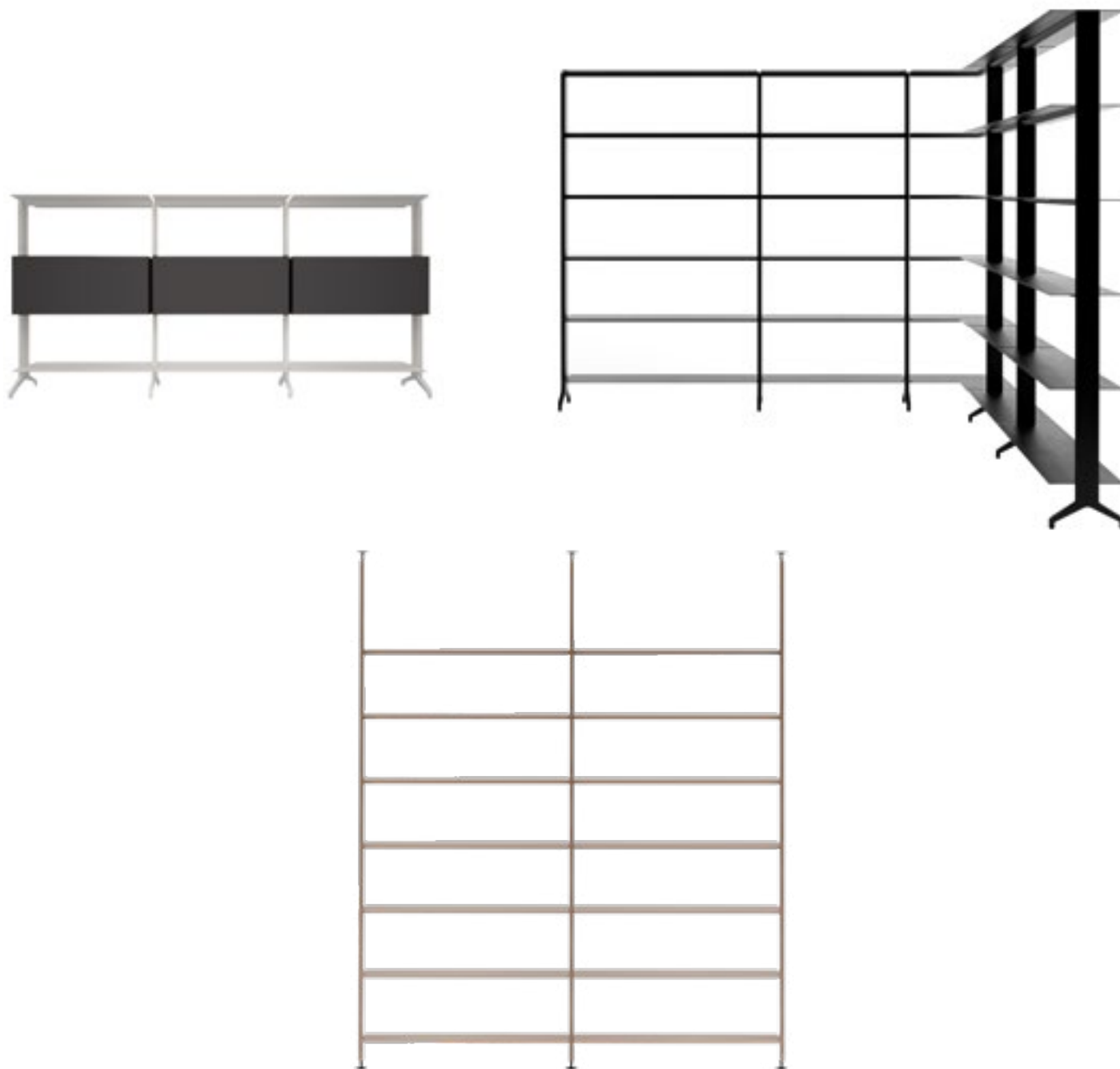

La libreria, nella sua semplicità e rigore, si configura come un vero e proprio elemento architettonico in grado di organizzare gli spazi. Un giunto angolare consente di creare diverse geometrie, ambienti chiusi, situazioni articolate. Aline, proposta in 4 differenti altezze, consente diverse configurazioni, da sideboard a libreria.

Thanks to its simplicity and rigour, the bookcase appears as a true architectural element capable of organising spaces. A corner element can be used to create different geometries, closed areas and more complex compositions. Aline is available in 4 different heights and it enables you to create different configurations, from sideboards to bookcases.

Mit seiner Schlichtheit präsentiert sich das Bücherregal wie ein echtes architektonisches Element für die Raumorganisation. Dank einer Eckverbindung können verschiedene Geometrien, geschlossene Bereiche oder verschiedene andere Formen realisiert werden. Aline ist in 4 verschiedenen Höhen erhältlich und zahlreichen Konfigurationen können realisiert werden, vom Sideboard bis zum Bücherregal.

La bibliothèque, dans sa simplicité et sa rigueur, se présente comme un véritable élément architectural capable d'organiser les espaces. Un joint angulaire permet de créer différentes géométries, espaces fermés, situations articulées. Aline, disponible en 4 hauteurs différentes, permet différentes configurations, du buffet à la bibliothèque.

# OVERVIEW

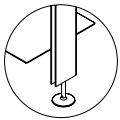
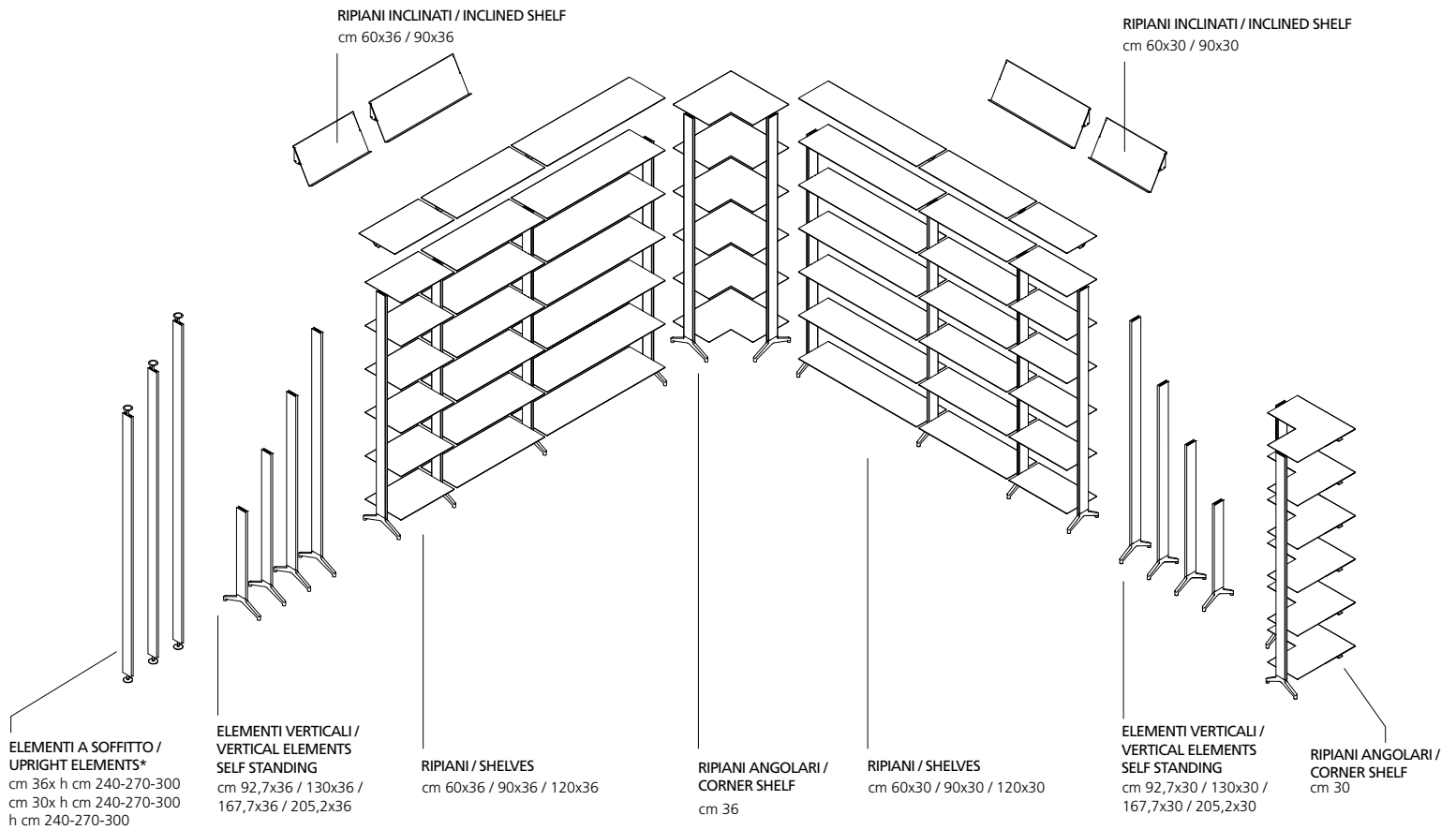

- \* Ogni montante ha alle estremità piedini regolabili in altezza di -5 cm/+10 cm. Il piedino sborda dalla struttura di 2,5 cm.
- \* Each upright element has -5 cm/+10 cm height adjustable feet at the end. The foot protrudes 2,5 cm out of the structure.
- \* Jeder Seitentraeger hat an den Enden -5 cm/+10 cm hoehenverstellbare Fuesse. Der Fuß tritt von 2,5 mm aus der Struktur hervor
- \* Chaque montant a aux extrémités des pieds réglables en hauteur de -5 cm/+10 cm. Le pied dépasse de la structure de 2,5 cm.

**NOTA MONTANTI:** I montanti sono predisposti con asole per fissaggio dei ripiani ed è possibile scegliere tra passo 125 mm o 375 mm. Considerando lo spessore di ogni ripiano di 30 mm, lo spazio utile tra i ripiani è 95 mm (con il passo 125 mm) o 345 mm (con il passo 375 mm).

**NOTE FOR VERTICAL ELEMENTS:** The vertical elements have predisposed holes to fix the shelves and you can choose between distance 125 mm or 375 mm. As every shelf is 30 mm thick, the exploitable space between the shelves is 95 mm (with distance 125 mm) or 345 mm (with distance 375 mm).

**HINWEIS FÜR DIE SEITENTRAEGER:** Die Seitenträger sind mit Schlitzen für die Befestigung der Tablaren ausgestattet und Sie können zwischen Abstand 125 mm oder 375 mm wählen. Jedes Tablar ist 30 mm dick, deshalb ist der verwendbare Raum zwischen den Tablaren 95 mm (mit Abstand 125 mm), oder 345 mm (mit Abstand 375 mm).

**NOTE MONTANTS:** les montants sont prédisposés avec des fentes pour la fixation des étagères et il est possible de choisir entre un pas de 125 mm ou 375 mm. Compte tenu de l'épaisseur de chaque étagère de 30 mm, l'espace utilisable entre les étagères est de 95 mm (avec le pas de 125 mm) ou de 345 mm (avec le pas de 375 mm).

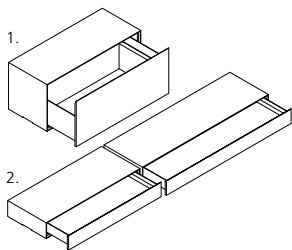

**DRAWERS**

1. cm 90x36 - h cm 37,5
2. cm 90x36 / 120x36 - h cm 12,5

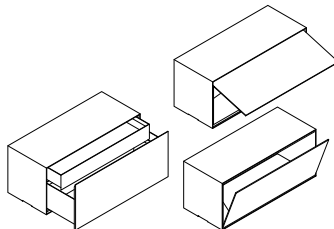

**SET OF 2 DRAWERS**

cm 90x36 - h cm 37,5

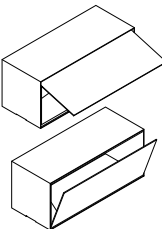

**FLAP DOOR**

cm 90x36 - h cm 37,5

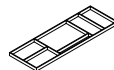

**DRAWER PARTITION**

cm 90x36

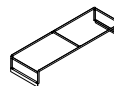

**HANGING FILE  
ADJUSTABLE FRAME**

cm 90x36



**SOUND ABSORBENT PANEL**

cm 60x4,5 - h cm 120 / cm 60x4,5 - h cm 160  
cm 120x4,5 - h cm 120 / cm 120x4,5 - h cm 160

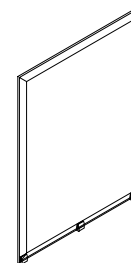

**MAGNETIC BOOKEND**



Istruzioni di montaggio  
Assembly instructions  
Montageanleitung  
Instructions d'assemblage

# INTERIOR SOLUTIONS



**ALINE**

FINISHES: TEXTURED LACQUERED ALUMINIUM/STEEL (A011)

**SAEN XS**

FINISHES: LACQUERED FULL COLOR (A047) LACQUERED MDF (V007)

**SLIM LOUNGE LOW**

FINISHES: TEXTURED LACQUERED ALUMINIUM (A011) FABRIC KVADRAT® C

## FINISHES

STRUTTURA / STRUCTURE / GESTELL / STRUCTURE

Alluminio/Acciaio verniciato goffrato  
Textured lacquered aluminium/steel  
Lackiertes gerauhtes Aluminium/Stahl  
Aluminium/Acier laqué granité



A019



A011



A047



A022



A051

Alluminio anodizzato (piedini)  
Anodized aluminium (glides)  
Aluminium eloxiert (gleiter)  
Aluminium anodiséé (pieds)



AS

CASSETTI / DRAWERS / SCHUBLADEN / TIROIRS

MDF laccato goffrato  
Textured lacquered MDF  
MDF lackiert gerauht  
MDF laqué granité



V005



V130



V003



V007



V110

Pannello fonoassorbente  
Acoustic panel  
Schalldämpfendes Paneel  
Panneau insonorisant



CA01



CA02

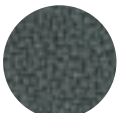

CA03



# ALINE WORK

DANTE BONUCCELLI

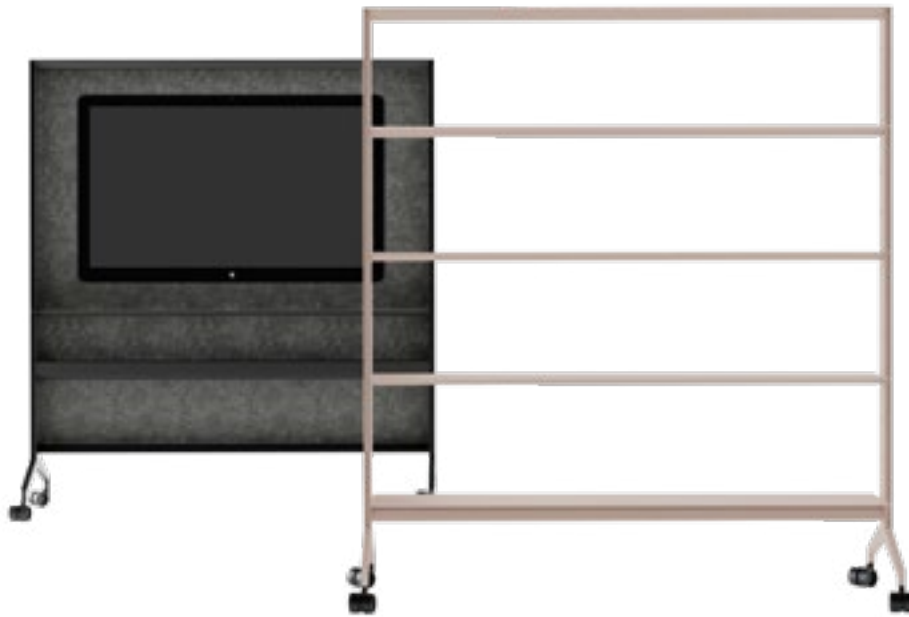

*Aline work* è il nuovo divisorio mobile multifunzione disegnato da Dante Bonuccelli per Alias. Una collezione di pareti mobili con le quali è possibile configurare gli spazi degli uffici e le zone del lavoro creando infinite soluzioni; *aline work* è una collezione coerente con i nuovi trend dell'ufficio contemporaneo organizzato in open spaces e con continue necessità di riorganizzazione degli spazi e dei teams di lavoro.

*Aline work* ist der neue multifunktionale bewegliche Raumteiler, der von Dante Bonuccelli für Alias entworfen wurde. Eine Kollektion von beweglichen Trennwänden, mit denen sich Büroräume und Arbeitsbereiche konfigurieren und unendlich viele Lösungen schaffen lassen. *Aline work* ist eine Kollektion, die den neuen Trends des modernen, in offenen Räumen organisierten Büros und der ständigen Notwendigkeit, Räume und Arbeitsteams neu zu organisieren, gerecht wird.

*Aline work* is the new multifunction mobile room divider exclusively designed by Dante Bonuccelli for Alias. A collection of movable walls with which it is possible to configure office spaces and work areas, creating infinite solutions. *Aline work* is a collection consistent with the new trends of the contemporary office organised in open spaces and with the continuous need for reorganisation of spaces and work teams.

*Aline work* est la nouvelle cloison mobile multifonctionnelle conçue par Dante Bonuccelli pour Alias. Une collection de parois mobiles, grâce auxquelles il est possible de configurer des espaces de bureau et des zones de travail en créant des solutions infinies. *Aline work* est une collection cohérente qui répond aux nouvelles tendances du bureau contemporain organisé en open space et au besoin continu de réorganisation des espaces et des équipes de travail.

# ALINE WORK



ALINE WORK BOOKSHELF



ALINE WORK DESK



ALINE WORK PANEL

Comprensivo di una vaschetta porta puntine (9x7 cm, altezza 6 cm).  
Including a pin tray (9x7 cm, height 6 cm).



ALINE WORK BOOKSHELF PANEL



## ALINE WORK



ALINE WORK PLANTER



ALINE WORK STAND



ALINE WORK MONITOR

Stabile e leggero, dal design lineare *aline work* è proposto in sette configurazioni differenti: pannello divisorio fonoassorbente, libreria bifacciale, libreria monofacciale, stand porta abiti, desk, parete monitor e giardino verticale.

Stable, light, with a linear design *aline work* is offered in seven different configurations: sound-absorbing partition panel, double-sided bookcase, single-sided bookcase, coat-stand, desk, monitor wall and vertical garden.

*Aline work* ist stabil, leicht, hat ein lineares Design und ist in sieben verschiedenen Konfigurationen erhältlich: schalldämpfende Trennwand, doppelseitiges Bücherregal, einseitiges Bücherregal, Kleiderständer, Schreibtisch, Monitorwand und vertikaler Garten.

Stable et léger, et arborant un design linéaire, le projet *aline work* est proposé dans sept configurations différentes : panneau de séparation insonorisé, bibliothèque double face, bibliothèque mono-face, porte-manteau, version bureau, mur d'écran et jardin vertical.

# DIMENSIONS

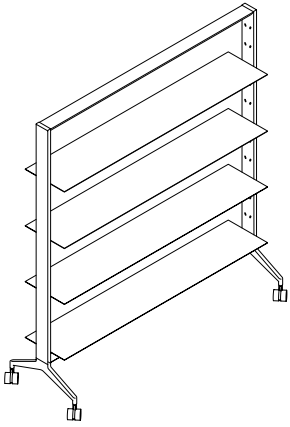

**ALINE WORK BOOKSHELF / J10**

cm 159x50 - h. cm 179

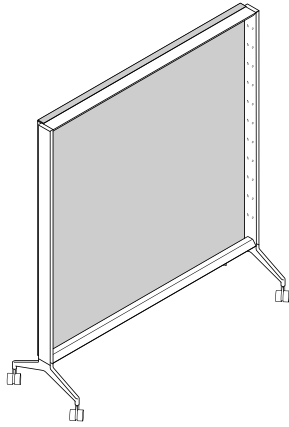

**ALINE WORK PANEL / J11**

cm 159x50 - h. cm 179

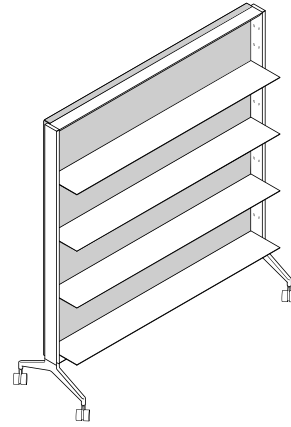

**ALINE WORK BOOKSHELF PANEL / J12**

cm 159x50 - h. cm 179

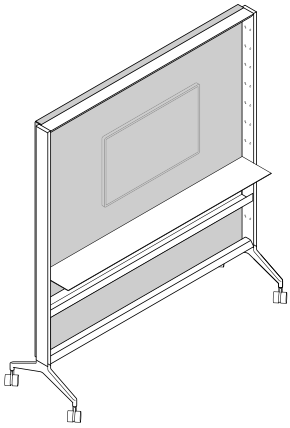

**ALINE WORK MONITOR / J13**

cm 159x50 - h. cm 179

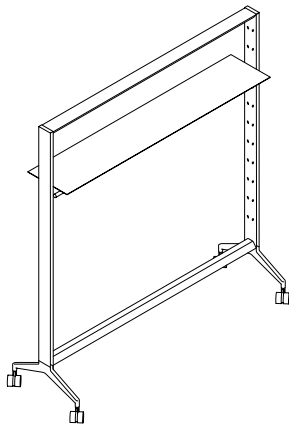

**ALINE WORK STAND / J14**

cm 159x50 - h. cm 179

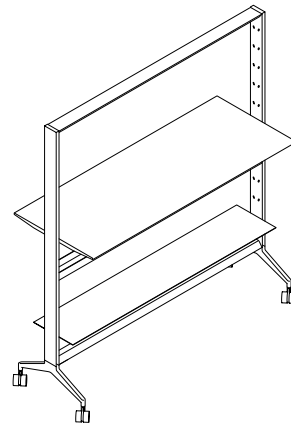

**ALINE WORK DESK / J15**

cm 140x60 - h. cm 179 - h cm top 107

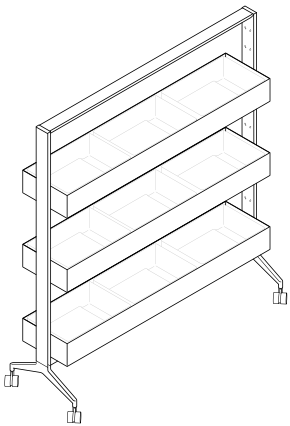

**ALINE WORK PLANTER / J16**

cm 159x50 - h. cm 179

# FINISHES

## STRUTTURA / STRUCTURE / GESTELL / STRUCTURE

Alluminio/Acciaio verniciato goffrato  
Textured lacquered aluminium/steel  
Aluminium/Stahl lackiert gerauht  
Aluminium/Acier laqué granité

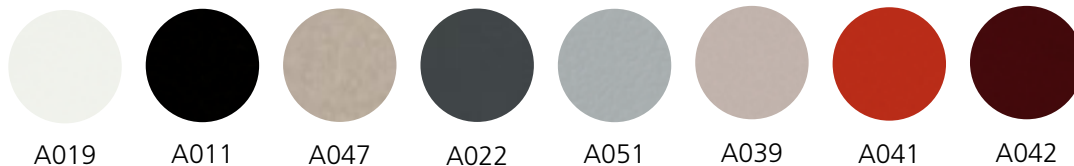

A019

A011

A047

A022

A051

A039

A041

A042

## PANNELLO / PANEL / PANEEL / PANNEAU

Feltro  
Felt  
Filz  
Feutre

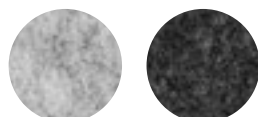

F007

F008

## PIANO (J15) / TOP (J15) / TISCHPLATTE (J15) / PLATEAU (J15)

Legno  
Wood  
Holz  
Bois

Rovere naturale  
Natural oak  
Eiche natur  
Chêne naturel

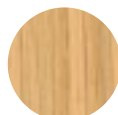

RV

Rovere sbiancato  
Whitened oak  
Eiche gebleicht  
Chêne blanchi



RVS

Rovere grigio cenere  
Ash grey oak  
Eiche aschgrau  
Chêne gris cendré



RC

Rovere scuro  
Dark oak  
Eiche dunkel  
Chêne foncé



RVT

Rovere noce canaletto  
Canaletto walnut oak  
Eiche canaletto nußbaum  
Chêne noyer canaletto



NCT

Verniciatura a poro aperto  
Coloured stains  
Offenporig lackiert  
Laquage à pore ouvert



V140



# BOOKCHAIR

SOU FUJIMOTO



La poetica progettuale di Sou Fujimoto, incontra la leggerezza tecnologica di Alias, per la quale sviluppa *bookchair*, una libreria domestica caratterizzata da un approccio fresco ed innovativo. Traendo ispirazione dal rapporto tra spazio architettonico e corpo umano, l'Architetto giapponese disegna una libreria compatta ed essenziale dalla quale è possibile estrarre una sedia. Un vero e proprio oggetto nell'oggetto che mette in risalto il rapporto tra l'uomo e il libro.

Die projektbezogene Poetik von Sou Fujimoto trifft die technologische Leichtigkeit von Alias und der Designer entwickelt somit *bookchair*, ein neues und innovatives Bücherregal für den Home Bereich. Der japanische Architekt inspiriert sich an dem Verhältnis zwischen architektonischem Raum und menschlichem Körper und entwirft ein kompaktes und essenzielles Bücherregal bei dem es möglich ist, einen Stuhl herauszuziehen. Ein echtes und eigentümliches Objekt innerhalb eines Objektes, dass das Verhältnis zwischen Mensch und Buch hervorhebt.

The design poetics of Sou Fujimoto meets the technological lightness of Alias, for which he creates *bookchair*, a bookcase for home characterised by a fresh, innovative approach. Drawing his inspiration from the relationship between the architectural space and the human body, the Japanese architect designed a compact, essential bookcase from which you can extract a chair. A veritable object within the object, which emphasizes the relationship between men and books.

La poésie conceptuelle de Sou Fujimoto, s'allie à la légèreté technologique d'Alias pour développer *bookchair*, une bibliothèque pour la maison singularisée par une approche fraîche et innovante. Puisant son inspiration dans la relation entre espace architectural et corps humain, l'architecte japonais a dessiné une bibliothèque compacte et épurée d'où il est possible d'extraire une chaise. Un véritable objet dans l'objet qui met en évidence le rapport entre l'homme et le livre.

## BOOKCHAIR



## INTERIOR SOLUTION



### **BOOKCHAIR**

FINSHES: LACQUERED MDF (V001)

### **BIPLANE XS**

FINSHES: TEXTURE LACQUERED STEEL (A019) LACQUERED MDF (V001)

## DIMENSIONS

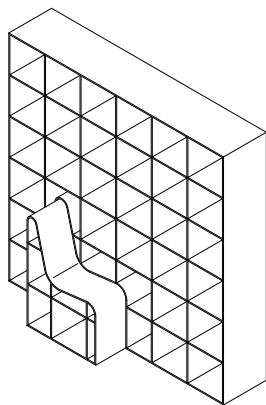

### BOOKCHAIR / 210

cm 200x40 - h cm 200 / CHAIR cm 64,5x40 - h cm 90 - h seat cm 46

La composizione molto semplice e pulita della libreria è arricchita dalle linee più morbide e sinuose della seduta. *Bookchair* è proposta solo in un colore, il bianco, a sottolineare l'astrattezza del pezzo e il forte legame tra il contenuto e il contenitore, e tra il contenitore e l'utilizzatore. Presentata in un'unica dimensione, bookchair è realizzata con pannelli in MDF laccato.

The simple and extremely clean configuration of the bookcase is enriched by the soft, sinuous lines of the chair. *Bookchair* is available in one colour only – white – in order to underline the abstractness of the product and the strong tie between the content and the container, between the container and the user. Proposed in one size, the bookchair is produced in lacquered MDF.

Die sehr einfache und schlichte Komposition des Bücherregals wird durch die weichen und harmonischen Linien des Stuhles bereichert. *Bookchair* ist nur in der Farbe weiß erhältlich, was die Abstraktheit des Gegenstandes unterstreicht und somit auch die starke Verbindung zwischen Inhalt und Regal sowie auch zwischen Regal und dem Benutzer. Bookchair gibt es in einer einzigen Größe und besteht aus Paneelen aus lackiertem MDF.

La composition très simple et minimaliste du meuble s'enrichit des lignes souples et sinueuses de la chaise. *Bookchair* n'est proposée qu'en une seule couleur, le blanc, afin de sublimer son abstraction ainsi que le lien étroit entre le contenu et le contenant et entre le contenant et l'utilisateur. Présentée en une seule dimension, bookchair est réalisée en MDF laqué.

## FINISHES

MDF laccato  
Lacquered MDF  
MDF lackiert  
MDF laqué



V001





# HUB

ALBERTO & FRANCESCO MEDA



Alberto e Francesco Meda firmano per Alias *hub*, la collezione che interpreta, nel suo rigoroso disegno, la tipologia del sistema modulare che si fissa a parete. Con *hub* è possibile realizzare diverse composizioni, reali soluzioni d'arredo che rispondono alle diverse esigenze del living: capienti librerie, pratici sideboard e pensili a giorno leggeri estendono le diverse possibilità funzionali del soggiorno.

Alberto und Francesco Meda haben für Alias *hub* entworfen, eine Kollektion, deren strenges Design das modulare System, das an der Wand befestigt werden kann, interpretiert. Mit *hub* ist es möglich, verschiedene Kompositionen zu schaffen, echte Einrichtungslösungen, die den unterschiedlichen Anforderungen des Wohnzimmers gerecht werden: Geräumige Bücheregale, praktische Sideboards und leichte, offene Hängeelemente erweitern die verschiedenen Funktionsmöglichkeiten des Wohnzimmers.

Alberto and Francesco Meda design *hub* for Alias, the collection that in its rigorous design interprets a typology of modular system that is fixed to the wall. With *hub* it is possible to create different compositions, real furnishing solutions that meet the different needs of the living room: capacious bookcases, practical sideboards and light open wall units extend the different functional possibilities of the living room.

Alberto et Francesco Meda ont conçu pour Alias *hub*, une collection dont le design rigoureux interprète le type de système modulaire fixé au mur. Avec *hub*, il est possible de créer différentes compositions, de véritables solutions d'ameublement qui répondent aux différents besoins du living: des bibliothèques spacieuses, des buffets pratiques et des unités murales ouvertes légères élargissent les différentes possibilités fonctionnelles du salon.

# HUB



HUB SIDEBOARD



HUB SIDEBOARD / HUB WALL UNIT



HUB BOOKSHELF



Discover all products of the collection hub on [alias.design](https://alias.design)  
Scopri tutti i prodotti della collezione hub su [alias.design](https://alias.design)

## INTERIOR SOLUTIONS



**HUB**  
FINSHES: TEXTURE LACQUERED ALUMINIUM/STEEL (A011) WOOD (RV)  
**ALUZEN SOFT**  
FINSHES: TEXTURE LACQUERED ALUMINIUM (A011) FABRIC ALIAS® LIVING I  
**SAEN XS**  
FINSHES: POLYURETHANE (V130) LACQUERED MDF (V130)



**HUB**  
FINSHES: TEXTURE LACQUERED ALUMINIUM (A011) COLOURED STAINS (V140) FABRICS ALIAS® LIVING  
**SAEN**  
FINSHES: LACQUERED POLYURETHANE (V130) LACQUERED MDF (V130)  
**NEW LADY SOFT CALYX**  
FINSHES: TEXTURE LACQUERED ALUMINIUM/STEEL (A011) FABRICS ALIAS® LIVING

# DIMENSIONS

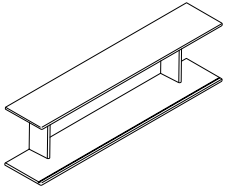

**HUB WALL UNIT 140 / H01**

cm 140x28/38 - h. cm 40

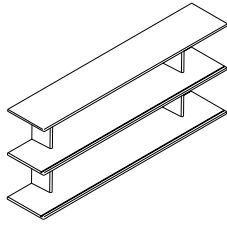

**HUB DOUBLE WALL UNIT 140 / H02**

cm 140x28/38 - h. cm 61,5

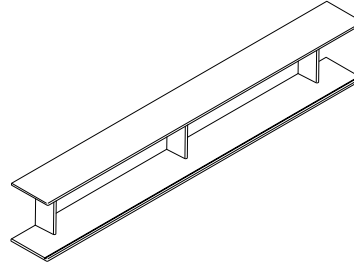

**HUB WALL UNIT 240 / H03**

cm 240x28/38 - h. cm 40

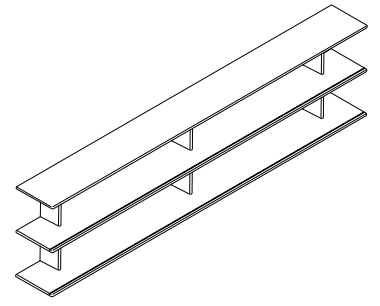

**HUB DOUBLE WALL UNIT 240 / H04**

cm 240x28/38 - h. cm 61,5

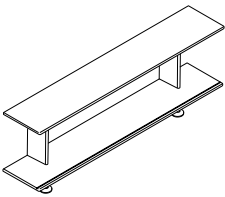

**HUB SIDEBOARD 140 / H05**

cm 140x28/38 - h. cm 55

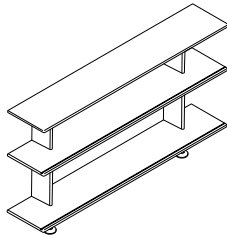

**HUB DOUBLE SIDEBOARD 140 / H06**

cm 140x28/38 - h. cm 84,5

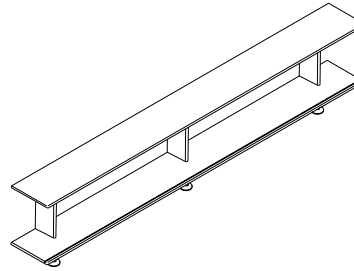

**HUB SIDEBOARD 240 / H07**

cm 240x28/38 - h. cm 55

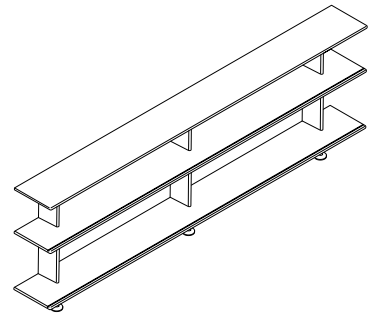

**HUB DOUBLE SIDEBOARD 240 / H08**

cm 240x28/38 - h. cm 84,5

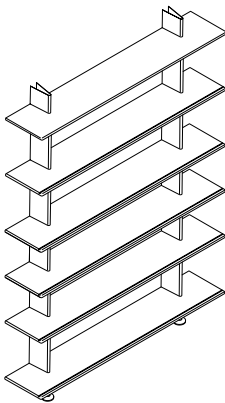

**HUB BOOKSHELF 140 / H09**

cm 140x28/38 - h. cm 200

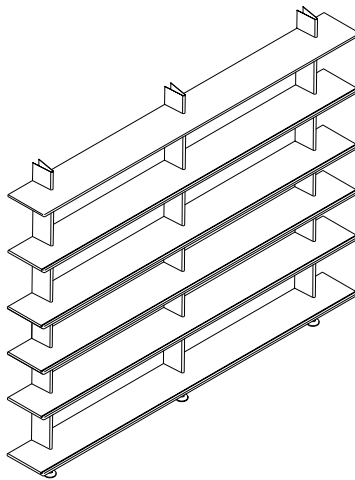

**HUB BOOKSHELF 240 / H10**

cm 240x28/38 - h. cm 200

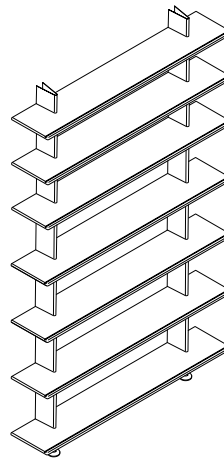

**HUB BOOKSHELF 140 / H11**

cm 140x28/38 - h. cm 238

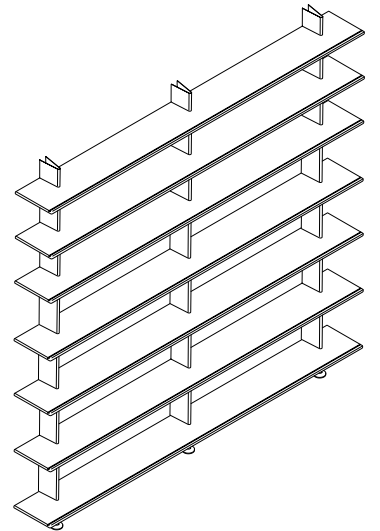

**HUB BOOKSHELF 240 / H12**

cm 240x28/38 - h. cm 238



**HUB FRONT PANEL / H19**

cm 100x28/36 - 50x28/36

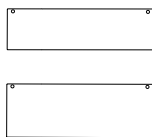

**HUB BACK PANEL / H20**

cm 97x27/35



**HUB COVER PANELS / H21**

cm 100x28/36 - 50x28/36

NOTA: ogni configurazione va fissata a muro ed è dotata dell'apposito kit di fissaggio.  
 NOTE: Every configuration must be fixed to a wall and it is equipped with a specific fixing kit.  
 HINWEIS: Jede Konfiguration soll am Wand befestigt werden und ist mit einem Befestigungskit ausgestattet.  
 NOTE: Chaque configuration doit être fixée au mur et elle est équipée du kit de fixation.

# FINISHES

## STRUTTURA & PANNELLO / STRUCTURE & PANEL / GESTELL & PANEEL / STRUCTURE & PANNEAU

Alluminio/Acciaio verniciato goffrato  
Textured lacquered aluminium/steel  
Lackiertes gerauhtes Aluminium/Stahl  
Aluminium/Acier laqué granité

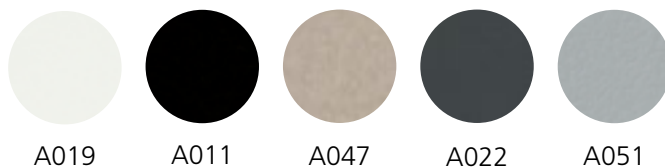

Alluminio/Acciaio verniciato metallizzato  
Metallic lacquered aluminium/steel  
Aluminium/Stahl metallic lackiert  
Aluminium/Acier laqué métallisé

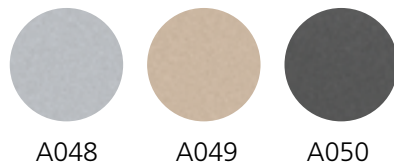

## RIPIANI / SHELVES / TABLAREN / ÉTAGÈRES

Legno  
Wood  
Holz  
Bois

Rovere naturale  
Natural oak  
Eiche natur  
Chêne naturel

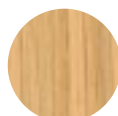

RV

Rovere sbiancato  
Whitened oak  
Eiche gebleicht  
Chêne blanchi



RVS

Rovere grigio cenere  
Ash grey oak  
Eiche aschgrau  
Chêne gris cendré



RC

Rovere scuro  
Dark oak  
Eiche dunkel  
Chêne foncé



RVT

Rovere noce canaletto  
Canaletto walnut oak  
Eiche canaletto nußbaum  
Chêne noyer canaletto



NCT

Verniciatura a poro aperto  
Coloured stains  
Offenporig lackiert  
Laquage à pore ouvert



V140

## COVER PER PANNELLI / COVER FOR PANELS / BEZUG FÜR PANEELE / COVER POUR PANNEAUX

Tessuti  
Fabric  
Stoff  
Tissu

**Alias®**  
Living I  
Living II

**Kvadrat® B**  
Maple  
Remix  
Tonus

**Kvadrat® C**  
Canvas  
Divina  
Foss  
Hallingdal 65  
Hero  
Steelcut  
Steelcut trio



# LAYOUT SECRÉTAIRE

MICHELE DE LUCCHI



Dalla sorprendente forma organica di *layout*, il sistema di mobili contenitore disegnato per Alias da Michele De Lucchi, viene sviluppato un nuovo progetto che conferisce un valore d'uso completamente nuovo. Il risultato è la creazione di un mobile secrétaire, un volume puro ed elementare che al suo interno accoglie un piano scrittoio e due piani d'appoggio fissati direttamente sulle ante. Questo mobile astratto attraverso un gesto semplice si schiude come un fiore e rivela la postazione di lavoro al suo interno, diventando l'architettura elementare dell'ufficio all'interno dell'architettura della stanza.

Aus der überraschenden organischen Form von *Layout*, dem von Michele De Lucchi für Alias entworfenen Schranksystem, wird ein neues Projekt entwickelt, das ihm einen völlig neuen Gebrauchswert verleiht. Das Ergebnis ist ein Secrétaire-Möbelstück, ein reines und elementares Volumen, das eine Schreibtischplatte und zwei direkt an den Türen befestigten Auflageflächen enthält. Durch eine einfache Geste öffnet sich dieses abstrakte Möbelstück wie eine Blume und offenbart einen Arbeitsplatz, so wird es zu einem wichtigen Stück Büroarchitektur innerhalb der Architektur des Zimmers.

From the surprising organic shape of *layout*, the storage furniture system designed for Alias by Michele De Lucchi, comes a new project that provides for a completely new use value. The result is the creation of a secrétaire piece of furniture, a pure and elementary volume that holds a desk top and two supporting shelves secured directly on the doors. Through a simple gesture, this abstract piece of furniture opens up like a flower and reveals the workstation within, becoming the elementary architecture of the office within the architecture of the room.

A partir de la forme organique surprenante de *layout*, le système de meubles de rangement conçu pour Alias par Michele De Lucchi, est développé un nouveau projet qui lui confère une valeur d'utilisation complètement nouvelle. Le résultat est la création d'un meuble secrétaire, un volume pur et essentiel qui accueille un plateau bureau et deux étagères fixées directement sur les portes. A travers un geste simple, ce meuble s'ouvre comme une fleur et révèle le poste de travail à l'intérieur, devenant l'architecture de base du bureau à l'intérieur de la pièce.

## LAYOUT



LAYOUT SECRÉTAIRE

## INTERIOR SOLUTIONS



LAYOUT SECRÉTAIRE  
FINISHES: TEXTURED LACQUERED ALUMINIUM (A019) WOOD (RV)  
NEW LADY CALYX  
FINISHES: TEXTURED LACQUERED ALUMINIUM (A019) FABRICS ALIAS® LIVING I  
ALINE  
FINISHES: EXTURED LACQUERED ALUMINIUM (A019)



## DIMENSIONS

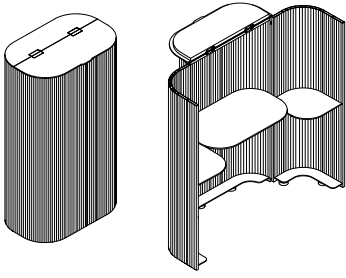

### LAYOUT SECRÉTAIRE / 80N

closed: cm 79x50 - h cm 135 / opened: cm 140x70 - h cm 137 - h. top cm 76

Il sistema modulare *layout* si arricchisce di nuovi estrusi di alluminio che, fissati all'elemento di forma ovale della base e del top, formano la struttura portante, su cui è possibile montare ante e i ripiani. *Layout secrétaire* è dotato di ruote che consentono di spostarlo con facilità da una zona all'altra. Opportune guarnizioni antipolvere preservano lo spazio interno del mobile.

The *layout* modular system acquires new extruded aluminium components, which are anchored to the oval form of the base and to the top, providing a bearing structure where to mount doors and shelves. *Layout secrétaire* is fitted with wheels, to easily move it from one place to another. Anti-dust gaskets protect its interior.

Das modulare System *layout* wird um neue Elemente aus Strangpressaluminium erweitert, die an dem ovalen Element des Gestells und des Oberteils befestigt werden: somit schaffen sie eine tragende Struktur, an die Türen und Tablare montiert werden können. *Layout secrétaire* ist mit Rollen ausgestattet und er kann von einem Bereich in den anderen verlegt werden. Der Innenraum des Möbels ist mit Staubschutzdichtungen versehen.

Le système modulaire *layout* s'enrichit de nouveaux éléments en aluminium qui, fixés à la forme ovale de la base et du dessus, forment une structure portante sur laquelle peuvent être montées portes et étagères. *Layout secrétaire* est muni de roulettes qui permettent de le déplacer aisément d'une zone à l'autre. Des joints antipoussière préservent l'espace intérieur du meuble.

## FINISHES

### STRUTTURA / STRUCTURE / GESTELL / STRUCTURE

Alluminio verniciato goffrato  
Textured lacquered aluminium  
Lackiertes gerauhtes Aluminium  
Aluminium laqué granité



A019



A011



A051

Alluminio verniciato metallizzato  
Metallic lacquered aluminium  
Aluminium metallic lackiert  
Aluminium laqué métalisé



A048

### PIANO / TOP / TISCHPLATTE / PLATEAU

Legno  
Wood  
Holz  
Bois

Rovere naturale  
Natural oak  
Eiche natur  
Chêne naturel

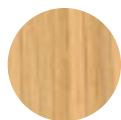

RV

Rovere noce canaletto  
Canaletto walnut oak  
Eiche canaletto nußbaum  
Chêne noyer canaletto



NCT



# SEC

ALFREDO HÄBERLI



*SEC* è il sistema di elementi componibili con struttura modulare portante in profili estrusi di alluminio. Per tutti i suoi componenti, in acciaio, vetro, metacrilato ed essenza, sono disponibili varie altezze, larghezze e profondità. Grazie alla varietà delle sue dimensioni, il sistema è configurabile e ha una componibilità infinita.

*SEC* ist ein Möbelbausystem mit einer tragenden Modulstruktur aus fließgepressten Aluminiumprofilen. Alle Komponenten aus Stahl, Glas, Acrylglas und Holz sind in verschiedenen Höhen, Breiten und Tiefen erhältlich. Aufgrund der unterschiedlichen Abmessungen ist das System unendlich erweiter- und kombinierbar.

*SEC* is a modular system with a bearing frame made of extruded aluminium elements. The components are in steel, glass, methacrylate and wood and are available in different heights, lengths, and widths. Thanks to its various dimensions the system is configurable and has infinite modularity in an infinite variety of compositions.

*SEC* est le système d'éléments composables avec structure modulaire portante en profils extrudés d'aluminium. Tous ses composants, en acier, verre, méthacrylate et en bois existent en différentes hauteurs, largeurs et profondeurs. Grâce à la variété des ses dimensions, ce système peut être composé et recomposé à l'infini.

# SEC



SEC CAR



SEC SID



SEC LIB



SEC TOR



For other models see our website. / *Per altri modelli consultare il nostro sito.*

**Set up SEC on "Sec Planner" on [alias.design](https://alias.design) / Configura SEC su "Sec Planner" su [alias.design](https://alias.design)**



---

SEC SID



---

SEC LIB

# OVERVIEW

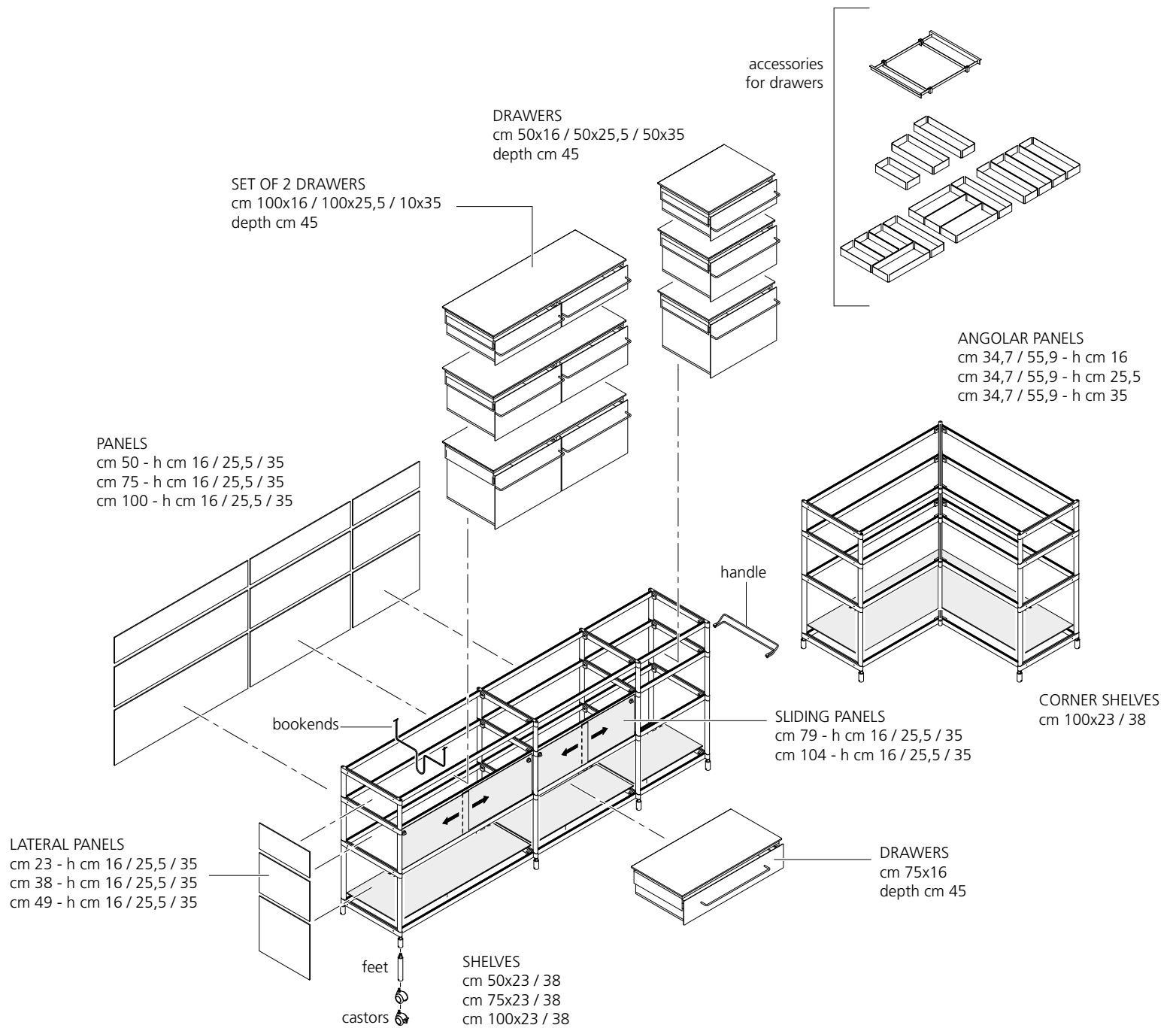

For other models see our website. / *Per altri modelli consultare il nostro sito.*  
**Set up SEC on "Sec Planner" on [alias.design](http://alias.design) / Configura SEC su "Sec Planner" su [alias.design](http://alias.design)**

# FINISHES

## STRUTTURA / STRUCTURE / GESTELL / STRUCTURE

Alluminio anodizzato / lucidato  
Anodized / polished aluminium  
Aluminium eloxiert / poliert  
Aluminium anodisé / poli

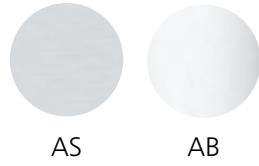

AS

AB

Alluminio verniciato goffrato  
Textured lacquered aluminium  
Aluminium lackiert gerauht  
Aluminium laqué granité

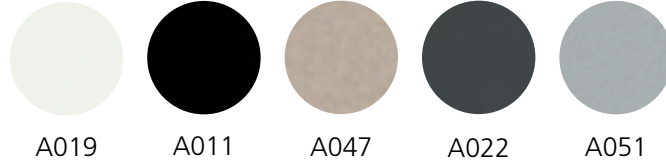

A019

A011

A047

A022

A051

## STRUTTURA & CASSETTI / STRUCTURE & DRAWERS / GESTELL & SCHUBLADEN / STRUCTURE & TIROIS

Acciaio verniciato goffrato  
Textured lacquered steel  
Lackiertes gerauhtes stahl  
Acier laqué granité

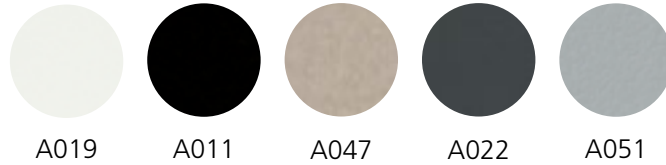

A019

A011

A047

A022

A051

Impiallacciato  
Veneered  
Furnierung  
Plaqué

Rovere naturale  
Natural oak  
Eiche natur  
Chêne naturel



RV

Rovere grigio cenere  
Ash grey oak  
Eiche aschgrau  
Chêne gris cendré

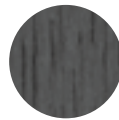

RC

Marmo bianco di Carrara  
Marble bianco Carrara  
Marmor bianco Carrara  
Marbre bianco Carrara



MA01

Vetro  
Glass  
Glas  
Verre



VTR

## PANNELLI & ANTE SCORREVOLI / PANELS & SLIDING PANLES / WÄNDE & SCHIEBETÜREN / CACHES & PORTES COULISSANTES

Metacrilato  
Methacrylate  
Acrylglas  
Méthacrylate



MT16

MT01

MT15

MT02

MT13





# TO'TAIME

PHILIPPE STARCK & EUGENI QUITLLET



L'appendiabiti. Oggetto della quotidianità. Scultura totemica nella visione di Philippe Starck con Eugeni Quitllet. Elegante, primitivo, modernissimo, *to'taime* è attrezzabile con un sistema di piani e contenitori per dare vita a composizioni interessanti sia negli effetti estetici che nelle funzionalità.

Der Garderobenständer. Ein Objekt des Alltags. Totemische Skulptur in der Vision von Philippe Starck und Eugeni Quitllet. Elegant, primitiv, äußerst modern kann *to'taime* mit Schale und Tablett ausgestattet werden. Dadurch entstehen interessante Kompositionen die durch Ästhetik und Funktionalität charakterisiert sind.

The coat-stand: an object of everyday life. A totem sculpture, as Philippe Starck and Eugeni Quitllet conceived it. Elegant, primitive, yet extremely modern *to'taime* can be fitted with a system of shelves and storage elements, creating compositions that are functional and aesthetically attractive.

Le porte-manteaux. Objet de la vie quotidienne. Sculpture totémique dans la vision de Philippe Starck et Eugeni Quitllet. Élegant, primitif, ultramoderne, *to'taime* peut être équipé d'un système de tablettes et de rangements pour créer des compositions intéressantes sur les plans esthétique et fonctionnel.

## TO'TAIME



*To'taime* si compone di tre elementi: una struttura centrale in alluminio estruso, base ed elemento superiore in fusione di alluminio. Disponibili due accessori: lo svuota-tasche, in lastra di alluminio tornita, ed il vassoio in alluminio, coordinabili all'appendiabiti proposti nella variante verniciata in diversi colori.

*To'taime* is comprised of three elements: a central structure in extruded aluminium, a base and an upper element, both in cast aluminium. It can be coordinated with two accessories: a pocket emptier in turned aluminium, and an aluminium tray, both available in the lacquered version in various colours.

*To'taime* besteht aus drei Elementen: die zentrale Struktur aus extrudiertem Aluminium, Ober- und Unterteil aus Aluminiumguss. Sie kann mit zwei Zubehörteilen koordiniert werden: eine Ablageschale aus gedrehtem Aluminiumblech und ein Tablett aus lackiertem Aluminium. Alle sind mit der lackierten Garderobenständer koordinierbar, verfügbar in verschiedenen Farben.

*To'taime* se compose de trois éléments: une structure centrale en aluminium extrudé, un piètement et un élément supérieur en fonte d'aluminium. Il peut être coordonné à deux accessoires: un vide-poche en plaque d'aluminium tournée, et un plateau en aluminium, tous se coordonnent au porte-manteaux disponible dans la version laquée en différentes couleurs.

## DIMENSIONS

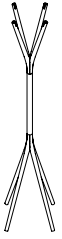

TO' TAIME / 030

cm 48x48 - h cm 175

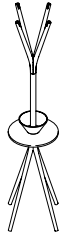

TO' TAIME+ / 033

cm 48x48 - h cm 175

## FINISHES

Alluminio/Acciaio verniciato gofrato  
Textured lacquered aluminium/steel  
Lackiertes gerauhtes Aluminium/Stahl  
Aluminium/Acier laqué granité



A019



A011



A047



A022



A051

# OUTDOOR

MOBILI DA ESTERNO • GARTENMÖBEL • MEUBLES POUR L'EXTÉRIEUR

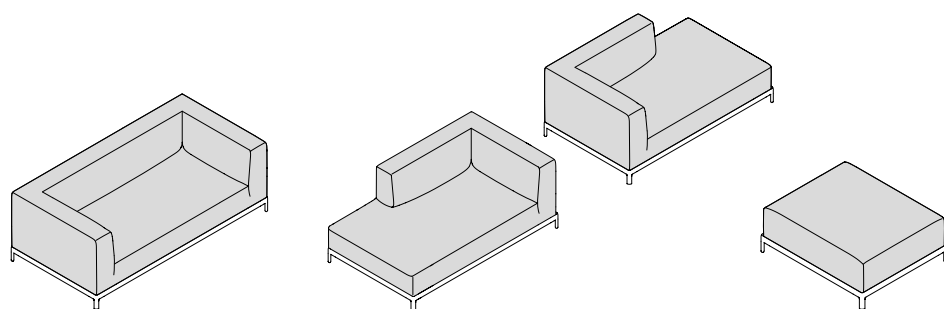

ALUZEN SOFT OUTDOOR  
pag. 210

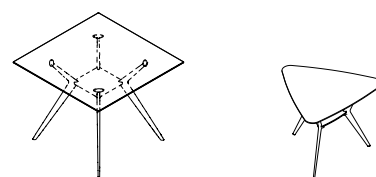

BIPLANE OUTDOOR  
pag. 120

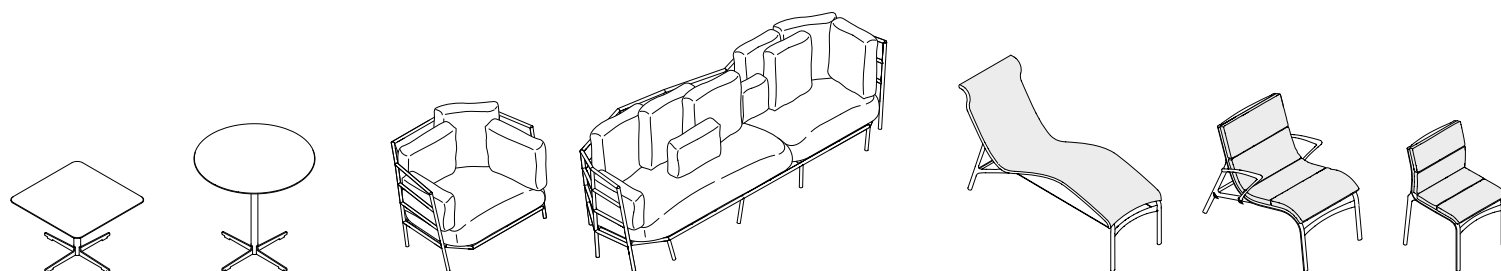

CROSS TABLE OUTDOOR  
pag. 128

DEHORS  
pag. 332

FRAME / FRAME SOFT OUTDOOR  
pag. 28

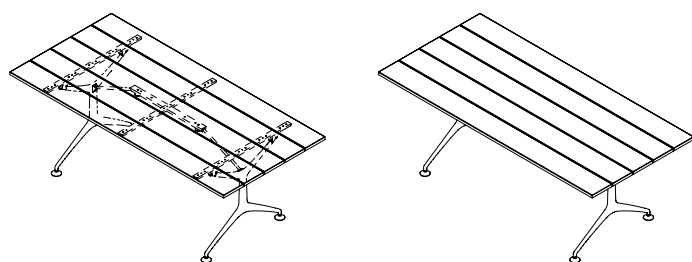

FRAMETABLE  
pag. 336



GRAN KOBI OUTDOOR  
pag. 238

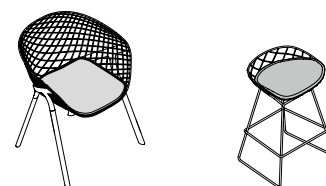

KOBI OUTDOOR  
pag. 52

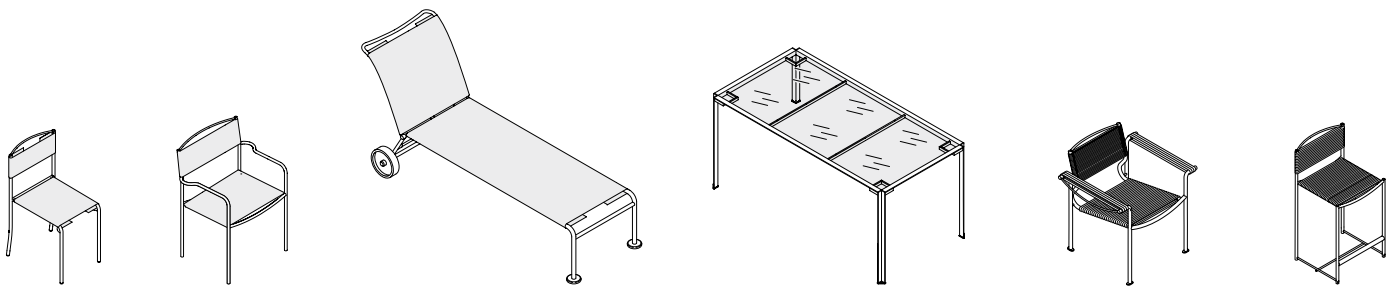

GREEN / GREEN PVC  
pag. 340

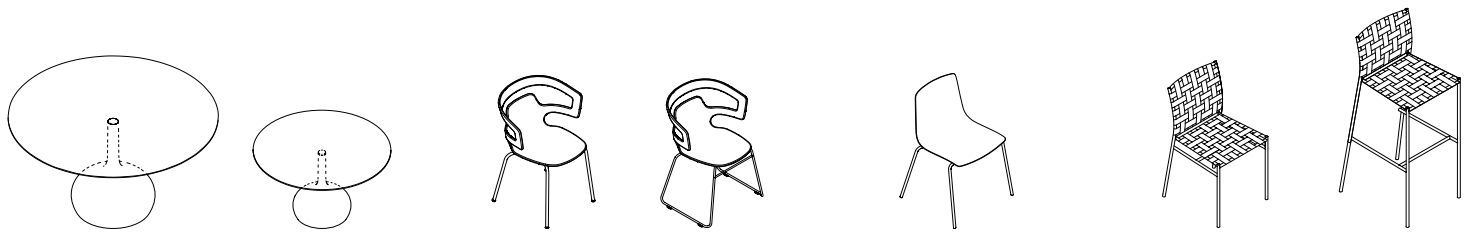

SAEN / SAEN XS OUTDOOR  
pag. 188

SEGESTA OUTDOOR  
pag. 98

SLIM CHAIR OUTDOOR  
pag. 84

TAGLIATELLE OUTDOOR  
pag. 348

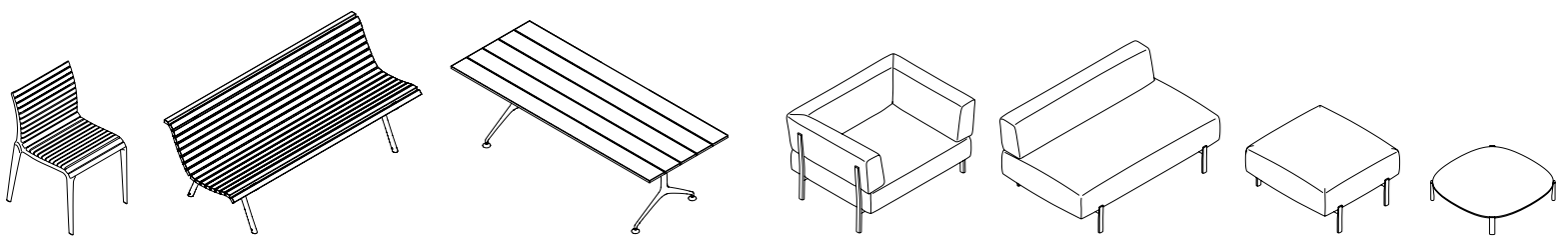

TECH WOOD  
pag. 352

TEN SYSTEM OUTDOOR  
pag. 358



# DEHORS

MICHELE DE LUCCHI



La collezione *dehors*, progettata per un ideale "salotto da giardino", si ispira coerentemente alla natura, all'irregolarità delle forme vegetali. I sostegni dei pezzi deviano dalle consuete linee verticali; il risultato è un insieme di strutture mosse, che si discostano da ogni rigore architettonico e offrono una inaspettata comodità.

Die Kollektion *dehors*, die für die Gestaltung eines authentischen "Salons im Garten" konzipiert ist, inspiriert sich passend zum Thema an der Natur und der unregelmäßigen Form von Pflanzen. Die Trägerstrukturen weichen von den gewohnten Vertikalen ab. Das Ergebnis ist eine bewegte Struktur, die sich von jeder architektonischen Regel befreit und gleichzeitig eine unerwartete Bequemlichkeit bietet.

The *dehors* collection is designed to create an ideal "garden living-room", inspired by nature and its irregular shapes. The structure of the products in the *dehors* collection differ from the usual vertical lines. The result is a collection of wavy structures that abandon any claim to architectural rigour and offer an unexpected degree of comfort.

La collection *dehors*, conçue pour un "salon de jardin" idéal, s'inspire non sans cohérence de la nature et de l'irrégularité des formes végétales. Les supports des articles s'éloignent des lignes verticales habituelles; le résultat est un ensemble de structures animées qui s'éloignent de toute rigueur architectonique et offrent un confort inattendu.

# DEHORS



DEHORS ARMCHAIR



DEHORS SOFA 2



DEHORS SOFA 3



DEHORS DORMEUSE



## DIMENSIONS

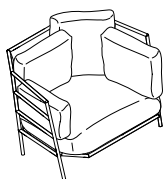

DEHORS ARMCHAIR / 370\_O

cm 108x83 - h cm 69 - h seat cm 44

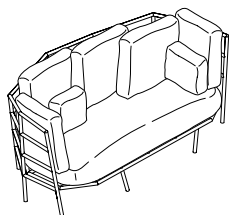

DEHORS SOFA 2 / 371\_O

cm 173x90 - h cm 69 - h seat cm 44

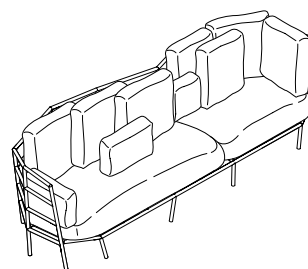

DEHORS SOFA 3 / 372\_O

cm 245x90 - h cm 69 - h seat cm 44

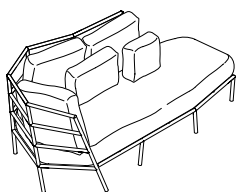

DEHORS DORMEUSE / 373\_O

cm 166x90 - h cm 69 - h seat cm 44

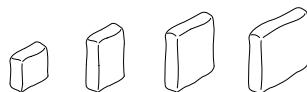

DEHORS CUSHIONS / 374\_O

cm 25x25 - 25x40 - 35x45 - 45x45

Cover protettive disponibili.  
Protective covers available.  
Schutzhüllen verfügbar.  
Couvertures de protection disponibles.

## FINISHES

### STRUTTURA / STRUCTURE / GESTELL / STRUCTURE

Acciaio verniciato goffrato  
Textured lacquered steel  
Lackiertes gerauhtes stahl  
Acier laqué granité

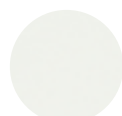

A019



A011



A047



A022



A051

### SEDUTA & SCHIENALE / SEAT & BACK / SITZ & RÜCKENLEHNE / ASSISE & DOSSIER

Tessuti  
Fabric  
Stoff  
Tissu

Alias®  
Living outdoor B

Tempotest® A



PT01

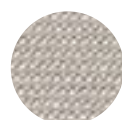

PT02

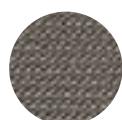

PT03

Scopri la collezione dehors  
Discover the dehors collection





# FRAMETABLE OUTDOOR

ALBERTO MEDA



Grazie alla ricerca tecnologica su cui Alias investe fin dalle sue origini, è stato sviluppato *frametable outdoor* caratterizzato da un sistema di piani in alluminio estruso che permettono di declinare lo storico progetto nella versione da esterni, senza comprometterne l'identità progettuale e l'immagine estetica. Un tavolo nuovo, tecnologico ed estremamente leggero che completa la proposta da esterno Alias.

Dank der technologischen Forschung, in die Alias seit seiner Gründung investiert hat, konnte *frametable outdoor* entwickelt werden, charakterisiert durch ein neues System von Platten aus stranggepresstem Aluminium, die den Einsatz des historischen Tisches im Außenbereich ermöglichen, ohne seine Designidentität und sein ästhetisches Erscheinungsbild zu beeinträchtigen. Ein neuer, technologischer und extrem leichter Tisch, der das Angebot von Alias für den Außenbereich vervollständigt.

Thanks to the technological research in which the company has been investing since its origins, it has been possible to develop *frametable outdoor* characterized by a new system of tops in extruded aluminium. This gave the opportunity to vary the historical project and to propose it in the outdoor version, without compromising its design identity and aesthetic image. A new, technological and extremely light table that completes Alias outdoor proposal.

La recherche technologique, dans laquelle Alias a investi dès sa création, a permis de développer *frametable outdoor* caractérisée par un nouveau système de plateaux en aluminium extrudé permettant de décliner le projet historique en version d'extérieur, en respectant son concept d'origine et son image esthétique. Une nouvelle table, technologique et extrêmement légère qui complète la proposition Alias pour l'extérieur.

# FRAMETABLE OUTDOOR



FRAMETABLE 190 FOLDING OUTDOOR



FRAMETABLE 190 OUTDOOR



FRAMETABLE 240 OUTDOOR

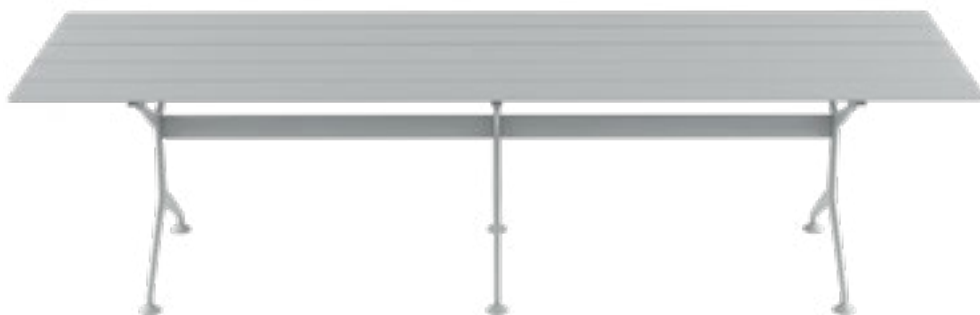

FRAMETABLE 295XL OUTDOOR

## DIMENSIONS

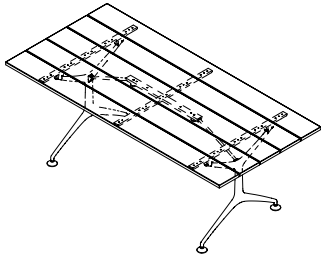

FRAMETABLE FOLDING / F02\_190\_O

cm 190x95 - h cm 75

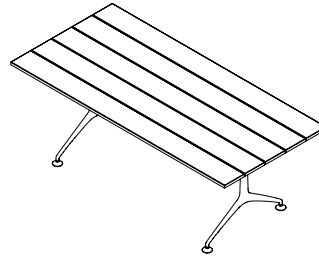

FRAMETABLE 190 OUTDOOR / F01\_190\_O

cm 190x95 - h cm 75

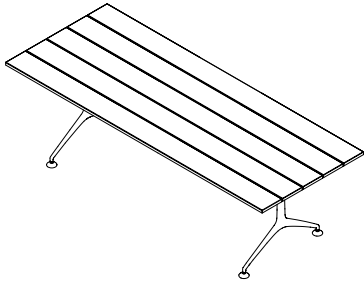

FRAMETABLE 240 OUTDOOR / F01\_240\_O

cm 240x95 - h cm 75

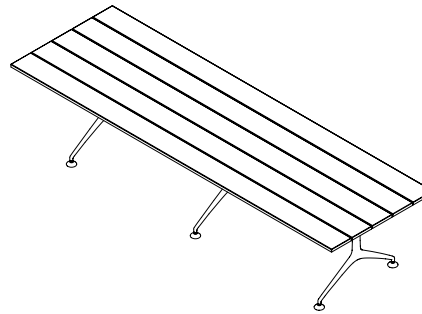

FRAMETABLE 295XL OUTDOOR / F01\_295\_O

cm 295x95 - h cm 75

## FINISHES

Alluminio verniciato gofrato  
Textured lacquered aluminium  
Lackiertes gerauhtes aluminium  
Aluminium laqué granité



A019

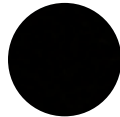

A011



A047



A022



A051



reddot winner 2022  
best of the best



# GREEN

GIANDOMENICO BELOTTI



Resistenza e praticità caratterizzano la collezione *green*. Strutture in acciaio inox spazzolato disegnano sedie, poltroncine, sgabelli e comode chaise longue, proposti con seduta e schienale in rete di poliestere spalmata di PVC o nella originale tessitura in tondino di PVC. Aggiungono forte identità all'insieme i tavoli disponibili in diverse dimensioni e finiture.

Festigkeit und Handlichkeit kennzeichnen die *green* Kollektion. Die Gestellen aus gebürstetem Edelstahl zeichnen Stühle, Sessel, Hocker und bequeme Chaise Longue bezogen mit einem aus feuerhemmendem PVC-beschichtetem Polyestergewebe oder mit der ursprünglicher PVC-Schnur. Die Tische in unterschiedlichen Abmessungen und Ausführungen verleihen der *green* Kollektion eine starke Persönlichkeit.

Resistance and practicality characterize the *green* collection. Frames in brushed stainless steel design chairs, small armchairs, stools and comfortable chaise longues with seat and back in PVC covered polyester mesh or with the original PVC strings. Tables with different dimensions and finishes add a strong identity to the collection.

Résistance et praticité caractérisent la collection *green*. Des structures en inox brossé dessinent chaises, petits fauteuils, tabourets et transats confortables, proposés avec assise et dossier en tissu polyester maillé enduit de PVC ou en fil PVC d'origine. Les tables disponibles avec plusieurs dimensions et finitions, ajoutent forte personnalité à l'ensemble.

# GREEN



GREEN GEMINI



GREEN ARMREST



GREEN ARMCHAIR



GREEN STOOL



GREEN HIGH STOOL

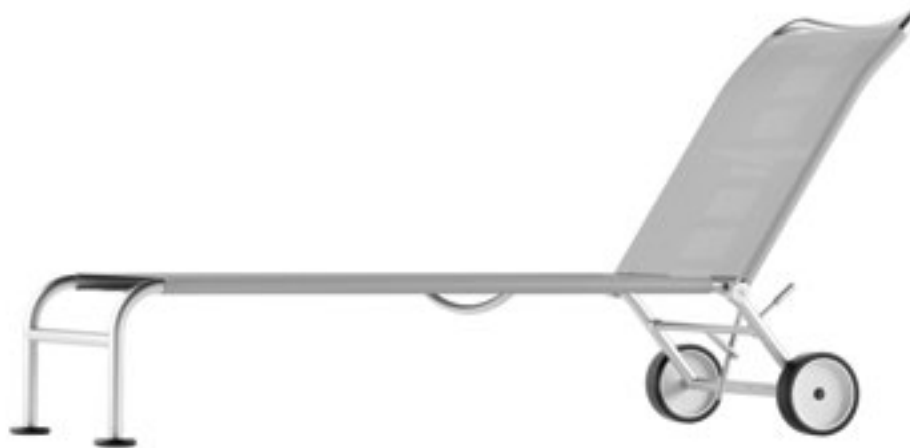

GREEN SUN LOUNGER



## GREEN PVC



---

### GREEN PVC ARMREST



---

### GREEN PVC ARMCHAIR



---

### GREEN PVC STOOLS

# GREEN TABLE

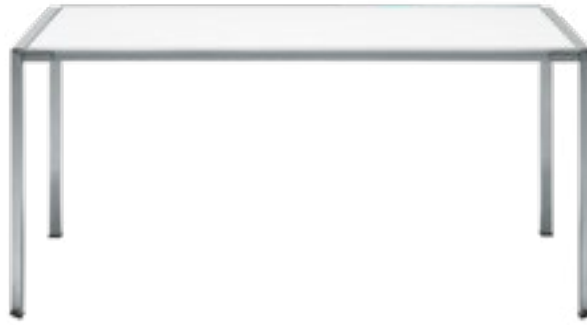

GREEN TABLE 160X80



GREEN TABLE 80X80



GREEN TABLE 135x135



GREEN TABLE 220x90



**GREEN PVC ARMREST**  
BRUSHED STAINLESS STEEL (IS)  
PVC (P020)  
**GREEN TABLE**  
BRUSHED STAINLESS STEEL (IS)  
DEKTON (DK01)

# DIMENSIONS

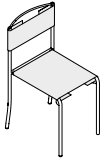

**GREEN GEMINI / 200\_O**

cm 42x52 - h cm 83 - h seat cm 47

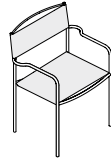

**GREEN ARMREST / 232\_O**

cm 64x53 - h cm 84 - h seat cm 46



**GREEN ARMCHAIR / 209\_O**

cm 68x59 - h cm 71 - h seat cm 42

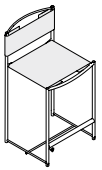

**GREEN STOOL / 224\_O**

cm 45x49 - h cm 87 - h seat cm 64

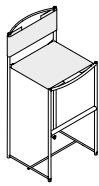

**GREEN HIGH STOOL / 225\_O**

cm 45x49 - h cm 102 - h seat cm 80

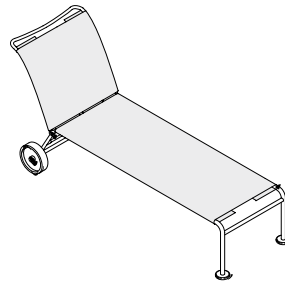

**GREEN SUN LOUNGER / 251\_O**

cm 68x195 - h cm 96 - h seat cm 35

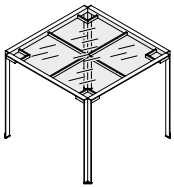

**GREEN TABLE 80X80 / 227\_O**

cm 80x80 - h cm 73,5

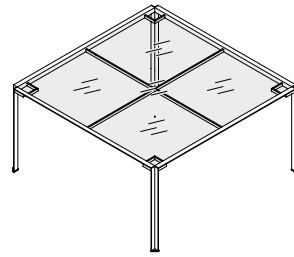

**GREEN TABLE 135x135 / 223\_O**

cm 135x135 - h cm 73,5

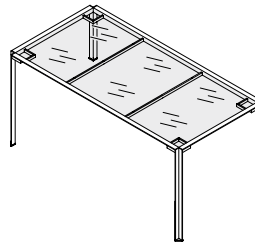

**GREEN TABLE 160x80 / 218\_O**

cm 160x80 - h cm 73,5

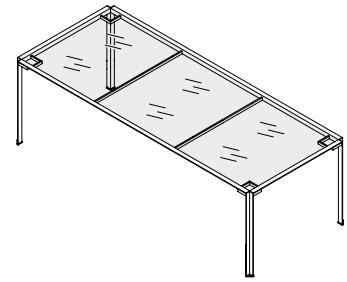

**GREEN TABLE 220x90 / 222\_O**

cm 220x90 - h cm 73,5



**GREEN PVC ARMREST / 201\_O**

cm 64x53 - h cm 84 - h seat cm 46



**GREEN PVC ARMCHAIR / 202\_O**

cm 68x58 - h cm 71 - h seat cm 42

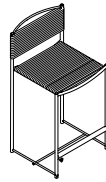

**GREEN PVC STOOL / 204\_O**

cm 45x49 - h cm 87 - h seat cm 64

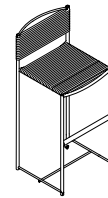

**GREEN PVC HIGH STOOL / 205\_O**

cm 45x49 - h cm 102 - h seat cm 80

# FINISHES

## STRUTTURA / STRUCTURE / GESTELL / STRUCTURE

Acciaio Inox spazzolato  
Brushed stainless steel  
Gebürsteter Edelstahl  
Acier inoxydable brossé



IS

## SEDUTA & SCHIENALE / SEAT & BACK / SITZ & RÜCKENLEHNE / ASSISE & DOSSIER

### GREEN

Rete  
Mesh  
Netzgewebe  
Tissu maillé



R009

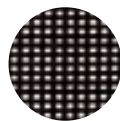

R007

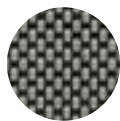

R028

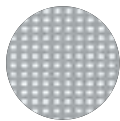

R003

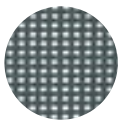

R006

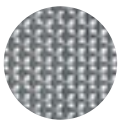

R020

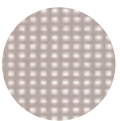

R011

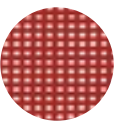

R024

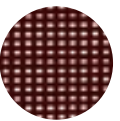

R025

### GREEN PVC

Tondino PVC  
PVC  
PVC-Schnur  
Fil PVC



P020



P021

## PIANO / TOP / TISCHPLATTE / PLATEAU

### GREEN TABLE

Vetro  
Glass  
Glas  
Verre



VX02

Dekton®  
Dekton®  
Dekton®  
Dekton®



DK01

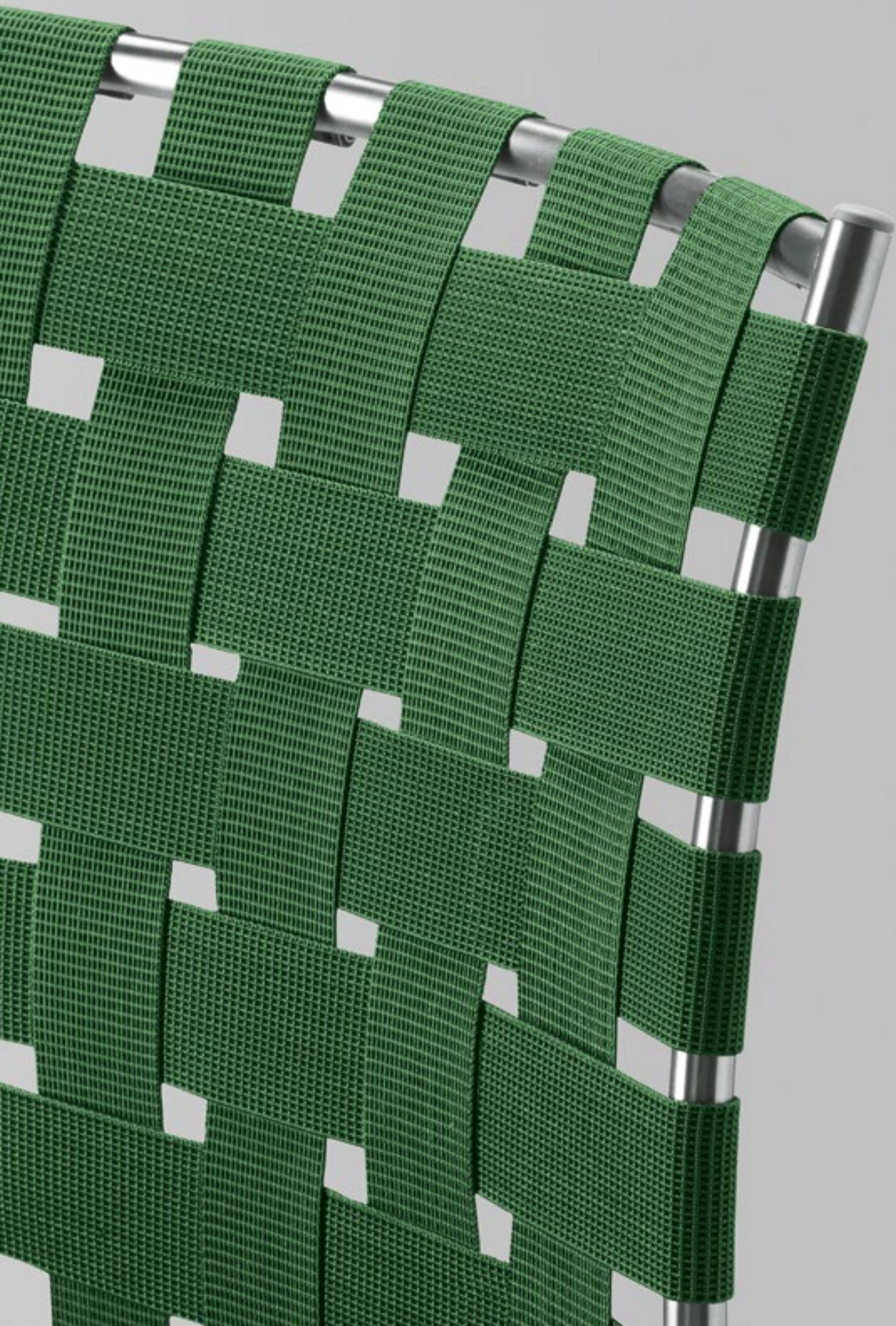

# TAGLIATELLE OUTDOOR

JASPER MORRISON



Il linguaggio diretto ed essenziale di Jasper Morrison incontra *spaghetti chair*; e di questa icona Alias, ne offre la sua originale reinterpretazione, citandone e riformulandone ogni elemento. La collezione *tagliatelle* prevede sedie impilabili, con e senza braccioli, comode poltroncine e pratici sgabelli.

Grazie alla struttura in acciaio inox e alle fasce elastiche che compongono seduta e schienale, l'intera famiglia si inserisce armoniosamente negli spazi verdi, creando un'atmosfera di raffinato relax.

Das direkte und unverkennbare Design von Jasper Morrison trifft den *spaghetti chair* und die Ikone von Alias wird neu interpretiert. Die *tagliatelle* Kollektion bietet stapelbare Stühle, mit oder ohne Armlehnen, bequeme Sessel und praktische Hocker. Dank dem Gestell aus Edelstahl und den Elastikbändern des Sitzes und der Rückenlehne integriert sich die ganze Kollektion harmonisch mit Grünflächen und erschafft eine entspannende und raffinierte Stimmung.

The direct and essential design of Jasper Morrison meets the *spaghetti chair*; Alias reinterprets this icon in an innovative way, redesigning each element. The *tagliatelle* collection is composed of stackable chairs, with or without arms, comfortable armchairs and practical stools. Thanks to its structure in stainless steel and the elastic belts covering the seat and the back, the whole collection harmoniously fits in green spaces, thus creating a relaxing and refined vibe.

La langage direct et épuré de Jasper Morrison rencontre *spaghetti chair*; de cette icône Alias, il offre son réinterprétation originale, en citant et en reformulant chaque élément. La collection *tagliatelle* comprend des chaises empilables, avec et sans accoudoirs, des fauteuils confortables et des tabourets pratiques. Grâce à la structure en acier inoxydable et aux bandes élastiques qui constituent l'assise et le dossier, toute la famille s'intègre harmonieusement dans les espaces verts, créant une atmosphère de détente raffinée.

TAGLIATELLE OUTDOOR



TAGLIATELLE CHAIR OUTDOOR



TAGLIATELLE ARMREST OUTDOOR



TAGLIATELLE ARMCHAIR OUTDOOR



---

TAGLIATELLE STOOLS OUTDOOR



## DIMENSIONS



TAGLIATELLE CHAIR OUTDOOR / 715\_O

cm 48x42 - h cm 79,5 - h seat cm 45,5



TAGLIATELLE ARMREST OUTDOOR / 716\_O

cm 50x48 - h cm 79,5 - h seat cm 45,5



TAGLIATELLE ARMCHAIR OUTDOOR / 717\_O

cm 55x58 - h cm 73 - h seat cm 39,5

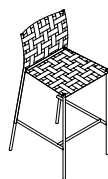

TAGLIATELLE STOOL OUTDOOR / 718\_O

cm 50x45 - h cm 96,5 - h seat cm 68,5

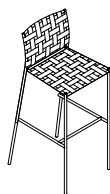

TAGLIATELLE HIGH STOOL OUTDOOR / 719\_O

cm 52x46 - h cm 109,5 - h seat cm 81,5

## FINISHES

### STRUTTURA / STRUCTURE / GESTELL / STRUCTURE

Acciaio Inox spazzolato  
Brushed stainless steel  
Gebürsteter Edelstahl  
Acier inoxydable brossé



IS

### SEDUTA & SCHIENALE / SEAT & BACK / SITZ & RÜCKENLEHNE / ASSISE & DOSSIER

Fasce elastiche  
Elastic belts  
Elastik Bänder  
Bandes élastiques

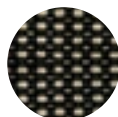

FE03



FE04



FE05

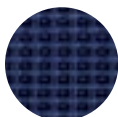

FE06

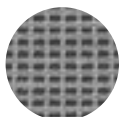

FE08



FE09

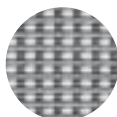

FE10



# TECH WOOD

ALBERTO MEDA



La collezione *tech wood* restituisce nei progetti di sedute, con e senza braccioli, e tavoli l'anima materica e formale della panchina *setes*, vincitrice del concorso "Una panchina per Milano" nel 2005. Realizzati con doghe di legno teak o frassino termotrattato su struttura in pressofusione di alluminio, i pezzi della collezione *tech wood* sono resistenti nel tempo e piacevoli al tatto. Ideale per gli spazi aperti, terrazze e giardini, i prodotti che compongono l'intera famiglia aggiungono solidità e cura dei dettagli al paesaggio outdoor.

Mit ihren Tischen und Stühlen mit und ohne Armlehnen gibt die Kollektion *tech wood* die materielle Essenz und die formelle Linie der Bank *setes* wieder, die im Jahr 2005 den Wettbewerb „Una panchina per Milano.“ (eine Bank für Mailand) gewonnen hat. Die Artikel der *tech wood* Kollektion sind mit Dauben aus Teak- oder wärmebehandeltem Eschenholz und einem Gestell aus Aluminiumdruckguss hergestellt; dank dieser sind sie im Laufe der Zeit besonders widerstandsfähig und fühlen sich angenehm an. Die Produkte der gesamten Serie sind für Freiflächen, Terrassen und Gärten ideal und verleihen der Außenlandschaft Kraft und Liebe zum Detail.

The *tech wood* collection with its table models and the chairs with or without arms returns to the material essence of the *setes* bench, that won the contest "Una panchina per Milano" (A bench for Milan) in 2005. Manufactured with slats of teak wood or heat-treated ash-wood on a die-cast aluminium frame, the products of the *tech wood* collection are resistant through time and pleasing to the touch. Ideal for open spaces, terraces and gardens, the products that make up the entire family add solidity and attention to detail to the outdoor landscape.

La collezione *tech wood* véhicule l'âme des matériaux et des formes du banc *setes*, gagnant du concours "Una panchina per Milano" en 2005, dans les projets de sièges avec et sans accoudoirs et tables. Réalisés en lattes de teck ou frêne thermotraité sur une structure en fonte d'aluminium, les articles de la collection *tech wood* résistent au temps et sont agréables au toucher. Parfaits pour les espaces ouverts, les terrasses et les jardins, les produits qui composent l'ensemble de la famille ajoutent au paysage extérieur solidité et attention aux détails.

## TECH WOOD SEATS



TECH WOOD CHAIR



TECH WOOD ARMREST



TECH WOOD BENCH

L'intera collezione *tech wood* si arricchisce della finitura in frassino termotrattato. Questo legno dopo completa essiccazione, subisce un trattamento termico che lo porta a una temperatura di circa 200° e un'umidità finale attorno al 5%. A seguito della lavorazione il materiale assume una colorazione marrone e ottima stabilità dimensionale che lo rende molto più versatile e più sostenibile.

The entire *tech wood* collection is enriched with the new finish in heat-treated ash. After complete drying, this wood undergoes a heat treatment that brings it to a temperature of about 200°C and a final humidity of about 5%. After processing, the material takes on a brown colour and excellent dimensional stability which makes it much more versatile and sustainable.

Die gesamte Kollektion *tech wood* wurde mit der neuen Ausführung wärmebehandelte Esche erweitert. Nach vollständiger Trocknung wird dieses Holz einer Wärmebehandlung unterzogen, bei der eine Temperatur von etwa 200° C und eine Endfeuchtigkeit von etwa 5% erreicht wird. Nach der Verarbeitung erhält das Material eine braune Farbe und eine ausgezeichnete Formbeständigkeit, wodurch es vielseitiger und nachhaltiger als Teakholz ist.

La finitura en frêne thermotraité a été ajoutée à l'ensemble de la collection *tech wood*. Après un séchage complet, ce bois subit un traitement thermique qui le porte à une température d'environ 200°C et à une humidité finale d'environ 5%. Après le traitement, le matériau assume une couleur brune et une excellente stabilité dimensionnelle, ce qui le rend beaucoup plus polyvalent et durable.

# TECH WOOD TABLES



TECH WOOD TABLE 200F



TECH WOOD TABLE 240



TECH WOOD TABLE 300



XXIII COMPASSO D'ORO ADI  
TECH WOOD FOLDING  
PREMIO / PRIZE



## INTERIOR SOLUTIONS



**TECH WOOD TABLE**

FINSHES: TEXTURE STOVE ENAMELLED ALUMINIUM (A011) WOOD (FRTT)

**FRAME SOFT 52**

FINSHES: TEXTURE STOVE ENAMELLED ALUMINIUM (A011) FABRICS ALIAS® LIVING OUTDOOR



**TECH WOOD TABLE FOLDING**

FINSHES: TEXTURE STOVE ENAMELLED ALUMINIUM (A019) WOOD (FRTT)

**TECH WOOD CHAIR ARMREST**

FINSHES: TEXTURE STOVE ENAMELLED ALUMINIUM (A019) WOOD (FRTT)

## DIMENSIONS



TECH WOOD CHAIR / M20\_O

cm 52x55 - h cm 81 - h seat cm 47



TECH WOOD ARMREST / M21\_O

cm 60x55 - h cm 81 - h seat cm 47

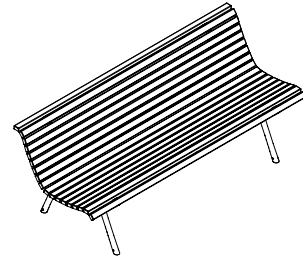

TECH WOOD BENCH / M22\_O

cm 199x75 - h cm 80 - h seat cm 42,5

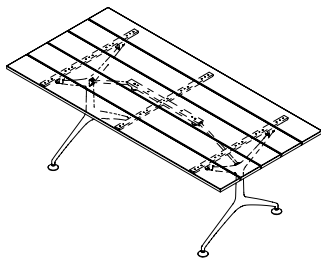

TECH WOOD TABLE 200F / M23\_O

cm 200x95 - h cm 75

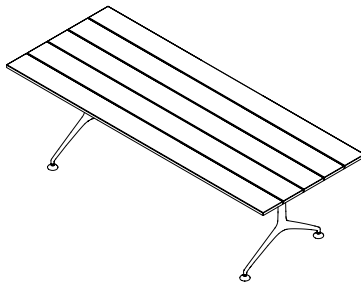

TECH WOOD TABLE 240 / M24\_O

cm 240x95 - h cm 75

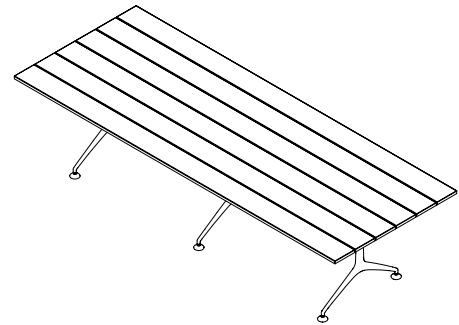

TECH WOOD TABLE 300 / M25\_O

cm 300x114 - h cm 75

## FINISHES

### STRUTTURA / STRUCTURE / GESTELL / STRUCTURE

Alluminio verniciato gofrato  
Textured lacquered aluminium  
Lackiertes gerauhtes aluminium  
Aluminium laqué granité



A019



A011



A047



A022



A051

### SEDUTA, SCHIENALE & PIANO / SEAT, BACK & TOP / SITZ, RÜCKENLEHNE & TISCHPLATTE / ASSISE, DOSSIER & PLATEAU

Legno  
Wood  
Holz  
Bois



TEAK



FRTT

It is a natural material and it could therefore be subject to colour changes, cracks and movements that may vary depending on the exposition to atmospheric agents and on the environment in which the product is placed.

Trattandosi di un materiale naturale, si possono verificare variazioni di colore, crepe e movimenti, che sono soggetti ad andamenti differenziati in funzione dell'esposizione agli agenti atmosferici e al tipo di ambiente in cui si trova il prodotto.

Es handelt sich um ein natürliches Material und deswegen könnten sich Farbwechsel, Risse und Bewegungen im Laufe der Zeit offenbaren. Diese variieren je nach der Exposition gegenüber Witterungseinflüssen und nach dem Umfeld, in dem das Produkt gestellt wird.

En tant que matériau naturel, des variations de couleur, des fissures et des mouvements peuvent se produire. Ceux-ci sont soumis à des tendances différenciées en fonction de l'exposition aux agents atmosphériques et du type d'environnement dans lequel le produit se trouve.



The mark of responsible forestry

Frassino termotrattato  
heat-treated ash  
Esche erweitert  
frêne thermotraité





# TEN SYSTEM OUTDOOR

PEARSONLLOYD



La collezione di imbottiti *eleven*, disegnata dal duo britannico PearsonLloyd, si arricchisce della versione da esterno *ten system*. La modularità di *ten system* rispecchia i canoni di Alias attraverso pochi elementi, ben identificati. Combinando tra loro i diversi moduli è possibile creare svariate configurazioni, dalle più classiche a quelle più contemporanee.

Die vom britischen Duo PearsonLloyd entworfene Polstermöbelkollektion *eleven*, wird durch die Outdoor-Version *ten system* bereichert. Die Modularität von *ten system* spiegelt die Standards von Alias durch einige klar identifizierte Elemente wider. Durch die Kombination der verschiedenen Module ist es möglich, viele Konfigurationen zu schaffen, von der klassischen bis zur modernsten.

The *eleven* collection of upholstered furniture, designed by the British duo PearsonLloyd, is enriched with the outdoor version *ten system*. The modularity of *ten system* reflects the standards of Alias through few well-identified elements. By combining the different modules it is possible to create various configurations, from the most classic to the most contemporary.

La collection de meubles rembourrés *eleven*, dessinée par le duo britannique PearsonLloyd, s'enrichit de la version pour l'extérieur *ten system*. La modularité de *ten system* reflète les standards d'Alias à travers peu d'éléments, clairement identifiés. La combinaison des différents modules permet de créer plusieurs configurations, des plus classiques aux plus contemporaines.

## TEN SYSTEM OUTDOOR



TEN CENTRAL OUTDOOR + TEN ANGULAR OUTDOOR



TEN ANGULAR OUTDOOR + TEN CENTRAL OUTDOOR + TEN DORMEUSE PUTDOOR

*Ten system* è perfetto per residenze private e situazioni contract, offrendo un sistema di imbottiti confortevole e dinamico che risponde alle esigenze contemporanee dell'abitare nelle quali le funzioni si sovrappongono e gli ambienti si trasformano.

*Ten system* is perfect for private residences and contract situations, offering a comfortable and dynamic upholstery system that responds to contemporary living needs in which functions overlap and environments are transformed.

Das *ten system* eignet sich perfekt für den privaten Wohnbereich und den Objektbereich und bietet ein komfortables und dynamisches Polstersystem, das den Bedürfnissen des modernen Wohnens entspricht, wo sich Funktionen überschneiden und Umgebungen verändert werden.

*Ten system* est parfait pour les résidences privées et les situations contrat, car il offre un système de meubles rembourrés confortable et dynamique, qui satisfait les exigences de l'habitat contemporain, où les fonctions se superposent et les cadres se transforment.



Discover Ten System moduls on **alias.design**  
Scopri i moduli Ten System su **alias.design**

## INTERIOR SOLUTIONS



**TEN SYSTEM**  
FINSHES: TEXTURE LACQUERED ALUMINIUM (A011) FABRICS ALIAS® LIVING OUTDOOR  
**ALUZEN LOW TABLE**  
FINSHES: TEXTURE LACQUERED ALUMINIUM (A011) GLAZED CERAMICA (V130)



**TEN SYSTEM**  
FINSHES: TEXTURE LACQUERED ALUMINIUM (A019) FABRICS ALIAS® LIVING OUTDOOR  
**SAEN XS OUTDOOR**  
POLYURETHANE (V001) GLAZED CERAMIC (V001)  
**GRAN KOBI OUTDOOR**  
FINSHES: TEXTURE LACQUERED ALUMINIUM (A019) FABRICS TEMPOTEST®

# DIMENSIONS

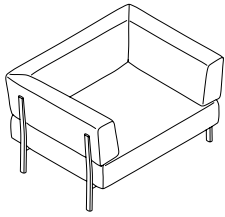

TEN ARMCHAIR OUTDOOR / T01\_O

cm 118x90 - h cm 72 - h seat cm 41

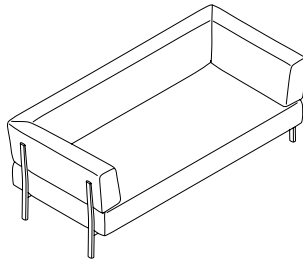

TEN SOFA 2 OUTDOOR / T02\_O

cm 194x90 - h cm 72 - h seat cm 41

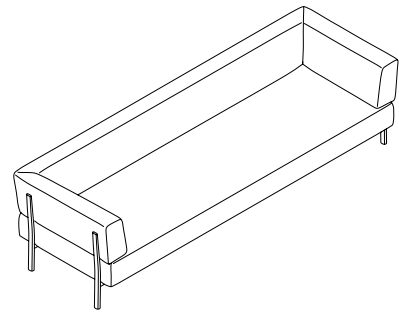

TEN SOFA 3 OUTDOOR / T03\_O

cm 270x90 - h cm 72 - h seat cm 41

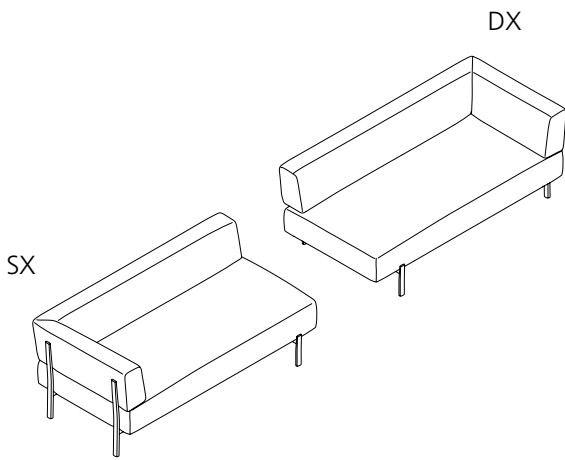

TEN ANGULAR OUTDOOR / T05\_O

cm 173x90 - h cm 72 - h seat cm 41

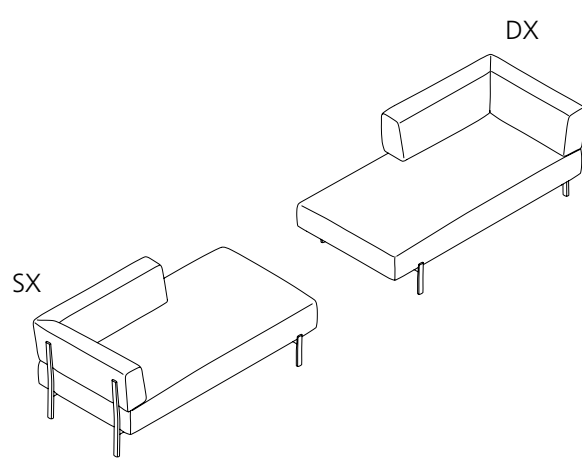

TEN DORMEUSE OUTDOOR / T06\_O

cm 173x90 - h cm 72 - h seat cm 41

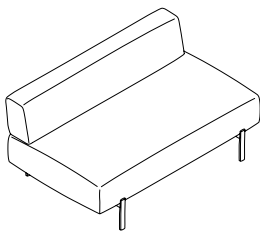

TEN CENTRAL OUTDOOR / T04\_O

cm 149x90 - h cm 72 - h seat cm 41

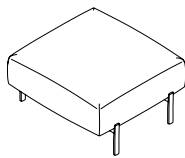

TEN POUF OUTDOOR / T07\_O

cm 90x85 - h cm 44

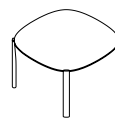

TEN LOW TABLE 60x60 OUTDOOR / T09\_O

cm 60x60 - h cm 37



TEN LOW TABLE 90x45 OUTDOOR / T08\_O

cm 90x45 - h cm 37

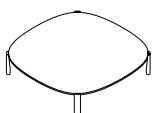

TEN LOW TABLE 80x80 OUTDOOR / T11\_O

cm 80x80 - h cm 22

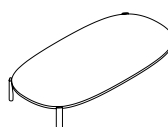

TEN LOW TABLE 120x60 OUTDOOR / T10\_O

cm 120x60 - h cm 22

# FINISHES

## STRUTTURA / STRUCTURE / GESTELL / STRUCTURE

Alluminio verniciato goffrato  
Textured lacquered aluminium  
Lackiertes gerauhtes aluminium  
Aluminium laqué granité

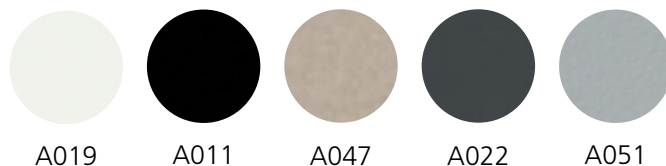

## SEDUTA & SCHIENALE / SEAT & BACK / SITZ & RÜCKENLEHNE / ASSISE & DOSSIER

Tessuto  
Fabric  
Stoff  
Tissu

**Alias®**  
Living outdoor B

**Tempotet® A**

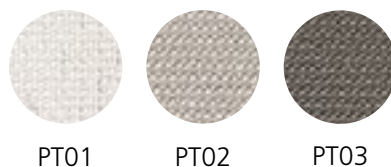

Ecopelle  
Eco-leather  
Kunstleder  
Simili cuir

**Serge Ferrari®**  
Stamskin Top®

## PIANO / TOP / TISCHPLATTE / PLATEAU

Ceramica smaltata  
Glazed ceramic  
Glasierte Keramik  
Céramique émaillée

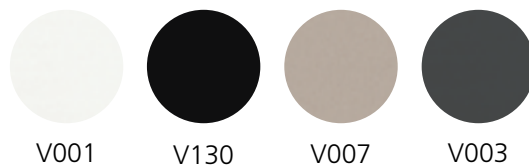

Cover protettive disponibili.  
Protective covers available.  
Schutzhüllen verfügbar.  
Couvertures de protection disponibles.

La collezione *ten system* outdoor comprende pratici tavolini che riprendono stilisticamente il design delle gambe degli imbottiti. I piani sono realizzati in ceramica stampata e smaltata, con proprietà superficiali e strutturali ideali per questo tipo di prodotto.

*Ten system* outdoor collection includes practical coffee tables that stylistically reflect the design of the legs of the upholstered furniture. The tops are made of pressed and glazed ceramic material, with surface and structural properties that are ideal for this type of product.

Die *ten system* Outdoor-Kollektion hat praktische Beistelltische, die stilistisch das Design der Beine der Polstermöbel übernehmen. Die Tischplatten bestehen aus geformter und glasierter Keramik, dessen Oberflächen- und Struktureigenschaften ideal für diese Art von Produkten sind.

La collection de plein air *ten system* comprend des tables pratiques basses, qui reprennent le style et la forme des pieds des meubles rembourrés. Les plateaux sont réalisés en céramique moulée et émaillée, dont les propriétés superficielles et structurelles sont idéales pour ce type de produit.





# *MATERIAlias*

## FINISHES

MATERIAlias is a project dedicated to gather all materials of our collection in a unique palette, organizing them according to materials, colours and finishes, in order to increasingly widen and simplify the choices of architects and interior designers. The project came up as an integrated material path where every colour, finish and material has been chosen to match with one another down to the smallest detail.

MATERIAlias è il progetto Alias dedicato a raccogliere in un'unica palette trasversale tutti i materiali in collezione secondo un ordine ragionato dal punto di vista materico, dei colori e delle finiture, per ampliare e facilitare sempre più le scelte di architetti e interior designer. Il progetto nasce come percorso materico integrato in cui ogni materiale, ogni finitura e ogni colore, sono stati scelti per dialogare bene gli uni con gli altri fino ai minimi dettagli.

## METAL / LACQUERED METAL

METALLO / METALLO VERNICIATO - METALL / METALL LACKIERT - MÉTAL / MÉTAL LAQUÉ

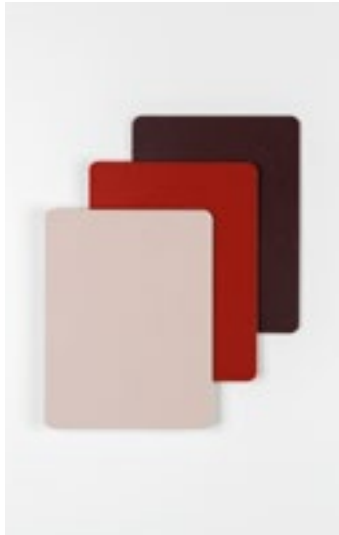

**Anodized aluminum**  
alluminio anodizzato /  
Aluminium eloxiert /  
aluminium anodisé

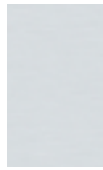

AS

**Chromed aluminium/steel**  
alluminio/acciaio cromato  
Aluminium/Stahl verchromt  
aluminium/acier chromé



CR

**Polished aluminum**  
alluminio lucidato /  
Aluminium poliert /  
aluminium poli



AB

**Brushed stainless steel**  
acciaio inox spazzolato /  
gebürsteter Edelstahl /  
acier inoxydable brossé



IS

**Lacquered textured**  
verniciatura goffrata /  
gerauht lackiert /  
laquage granité



A011

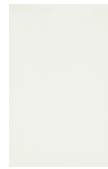

A019



A022



A047



A051



A039



A041



A042

**Metallic lacquered aluminum**  
alluminio verniciato metallizzato /  
Aluminium metallic lackiert /  
aluminium laqué métallisé

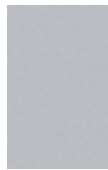

A048

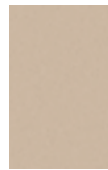

A049



A050

## LAMINATE

LAMINATO / LAMINAT / LAMINÉ



L005

L006

L010

FULL COLOR



FC01

FC04

## LAMINATE FENIX®

LAMINATO FENIX® / FENIX® LAMINAT / LAMINÉ FENIX®



FENIX 0032

FENIX 0720

FENIX 0724

FENIX 0748

FENIX 0752

▲ Sample: available on request only  
Campione: disponibile su richiesta  
Muster: verfügbar auf Anfrage  
Echantillon: disponible sur demande

For Landscape only

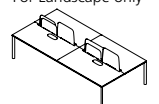



## BILAMINATE

BILAMINATO / BILAMINAT / BILAMINÉ



BBCO

BNRO

## GLAZED CERAMIC

CERAMICA SMALTATA / GLASIERTE KERAMIK / CÉRAMIQUE ÉMAILLÉE



V001

V130

V003

V007

▲ Sample: only V007 available  
Campione: disponibile solo V007  
Muster: nur V007 verfügbbar  
Echantillon: disponible seulement V007

## MATT LACQUER

LACCATURA OPACA / MATTLACK / LAQUAGE OPAQUE



V001

V003

V007

V130

V110

## WOOD

LEGNO / HOLZ / BOIS

### Oak

Rovere /  
Eiche /  
chêne



RV

Possible imperfections of the products and alterations during the time depend on the natural materials used and on the handicraft work process, therefore they cannot be considered as defects. Alias products are not mass-produced, but each product is unique.

Eventuali imperfezioni dei prodotti e variazioni nel tempo, sono dovute all'uso di materiali naturali e a tecniche di lavorazione artigianali; non sono pertanto da considerarsi dei difetti. I prodotti di Alias non sono realizzati in serie, ma ogni prodotto è unico.

Mögliche Unvollkommenheiten und Variationen, die im Laufe der Zeit auftreten können, sind auf die Verwendung von natürlichen Materialien und handwerklichen Techniken zurückzuführen; daher sind diese nicht als Mängel zu betrachten. Alias-Produkte werden nicht in Serie hergestellt, sondern jedes Produkt ist ein Unikat.

D'éventuelles imperfections des produits et changements dans le temps, sont dus à l'utilisation de matériaux naturels et à techniques de travail artisanales; elles ne doivent donc pas être considérées des défauts. Les produits de Alias ne sont pas réalisés en série, mais chaque produit est unique.

Ash grey oak /  
rovere grigio cenere /  
Eiche aschgrau /  
chêne gris cendré



RC

Whitened oak /  
rovere sbiancato /  
Eiche gebleicht /  
chêne blanchi



RVS

Dark oak /  
rovere scuro /  
Eiche dunkel /  
chêne foncé



RVT

Canaletto walnut oak /  
rovere noce canaletto /  
Eiche canaletto nußbaum /  
chêne noyer canaletto



NCT

Natural ash /  
frassino naturale /  
Esche natur /  
frêne naturel



TFRN

Natural maple /  
acero naturale /  
Ahorn natur /  
érable naturel



ACN

### Coloured stains

verniciatura a poro aperto /  
offenporig lackiert /  
laquage à pore ouvert



V140

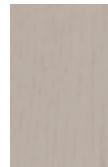

V142



V131

## OUTDOOR WOOD

LEGNO DA ESTERNO / HOLZ FÜR AUßENBEREICH / BOIS POUR L'EXTÉRIEUR



### Teak

Teak /  
Teak /  
Teak

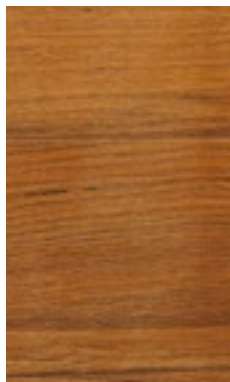

TEAK

### Heat-treated ash wood

Frassino termotrattato /  
Wärmebehandeltes  
Eschenholz /  
Frêne Thermotraité

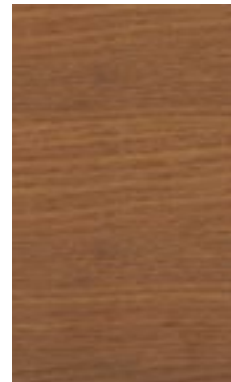

FRTT

▲ Sample: available on request only  
Campione: disponibile su richiesta  
Muster: verfügbare auf Anfrage  
Echantillon: disponible sur demande

It is a natural material and it could therefore be subject to colour changes, cracks and movements that may vary depending on the exposition to atmospheric agents and on the environment in which the product is placed.

Trattandosi di un materiale naturale, si possono verificare variazioni di colore, crepe e movimenti, che sono soggetti ad andamenti differenziati in funzione dell'esposizione agli agenti atmosferici e al tipo di ambiente in cui si trova il prodotto.

Es handelt sich um ein natürliches Material und deswegen könnten sich Farbwechsel, Risse und Bewegungen im Laufe der Zeit offenbaren. Diese variieren je nach der Exposition gegenüber Witterungseinflüssen und nach dem Umfeld, in dem das Produkt gestellt wird.

En tant que matériau naturel, des variations de couleur, des fissures et des mouvements peuvent se produire. Ceux-ci sont soumis à des tendances différenciées en fonction de l'exposition aux agents atmosphériques et du type d'environnement dans lequel le produit se trouve.

## METHACRYLATE

METACRILATO / ACRYLGLAS / MÉTHACRYLATE



MT01 MT02 MT13 MT15 MT16

## GLASS

VETRO / GLAS / VERRE



DB01 DB02 DB03 DB05 VTT

▲ Sample: available on request only  
Campione: disponibile su richiesta  
Muster: verfügar auf Anfrage  
Echantillon: disponible sur demande

## GLASS

VETRO / GLAS / VERRE

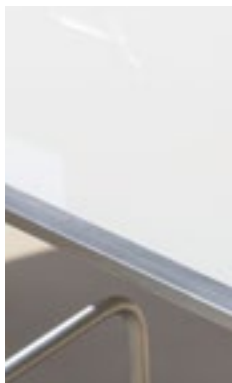

VX02

▲ Sample: available on request only  
Campione: disponibile su richiesta  
Muster: verfügar auf Anfrage  
Echantillon: disponible sur demande



For Green table only

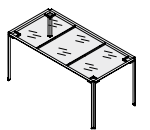

## ACRYLIC STONE

PIETRA ACRILICA / NATURACRYLSTEIN / PIERRE ACRYLIQUE

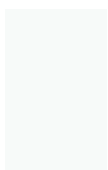

PR01

▲ Sample: available on request only  
Campione: disponibile su richiesta  
Muster: verfügar auf Anfrage  
Echantillon: disponible sur demande



DEKTON®

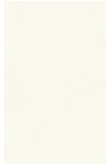

▲ Sample: available on request only  
Campione: disponibile su richiesta  
Muster: verfügbbar auf Anfrage  
Echantillon: disponible sur demande

DK01

For Green table only

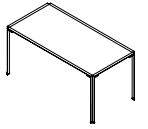

## GRES STONEWARE GRES / FEINSTEINZEUG / GRÈS

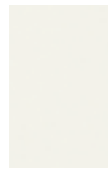

CE10



CE13

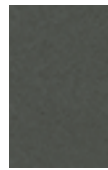

CE12

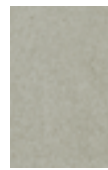

CE11

▲ Sample: available on request only  
Campione: disponibile su richiesta  
Muster: verfügbbar auf Anfrage  
Echantillon: disponible sur demande

## MARBLE BIANCO CARRARA "C" MARMO BIANCO DI CARRARA / MARMOR BIANCO CARRARA / MARBRE BIANCO CARRARA



MA01

Marble is a natural material, whose features remain unchanged during all the production phases. For this reason the veins, the shades of colour and the slight irregularities could present some variations which are not defects but values which enhance the uniqueness of the product.

Il marmo è un materiale naturale, le cui caratteristiche rimangono inalterate durante tutte le fasi di lavorazione. Per questa ragione le venature, le tonalità di colore e le lievi irregolarità superficiali possono presentare delle differenze che non devono essere considerati difetti, bensì pregi che esaltano l'unicità del prodotto.

Marmor ist ein natürliches Material, dessen Eigenschaften während aller Bearbeitungsphasen unverändert bleiben. Aus diesem Grund können die Änderungen, die Farbtöne und leichte Oberflächenunregelmäßigkeiten Unterschiede aufweisen, die nicht als Fehler betrachtet werden sollten, sondern als Qualitäten, die die Einzigartigkeit des Produkts erhöhen.

Le marbre est un matériau naturel, dont les caractéristiques restent inchangées pendant toutes les phases de traitement. Pour cette raison les veinures, les tonalités de couleur et les légères irrégularités peuvent présenter des différences qui ne doivent pas être considérées des défauts, mais des qualités qui mettent en évidence l'unicité du produit.

## PLASTIC MATERIAL

MATERIALE PLASTICO / KUNSTSTOFFMATERIAL / MATÉRIAU PLASTIQUE

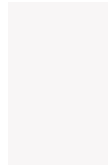

H112

Polypropylene  
Polipropilene /  
Polypropylen /  
Polypropylene



PP01

PP02

PP03

PP04

PP05

## PVC

PVC / PVC-SCHNUR / FIL PVC



P000

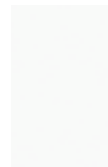

P001

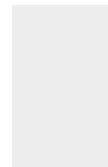

P002



P009



P019



P021

PVC (Ø 4mm)



P020



P021



PVC (Ø 5mm)

## PAPER STRAW

PAGLIA / BASTGEFLECHT / PAILLE



PG01



PG04



PG05



PG06

For Paludis only



**MESH**  
RETE / NETZGEWEBE / MAILLE



**Mesh A**  
Rete A /  
Netzgewebe A /  
Maille A

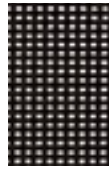

R007



R009

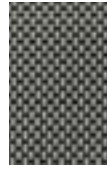

R028

**Mesh B**  
Rete B /  
Netzgewebe B /  
Maille B

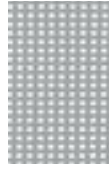

R003

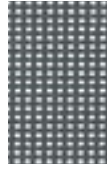

R006

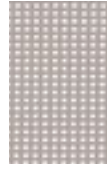

R011



R020

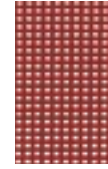

R024



R025

**ELASTIC BELTS**  
FASCE ELASTICHE / ELASTIKBÄNDER / BANDES ÉLASTIQUES



FE03



FE04



FE05



FE06

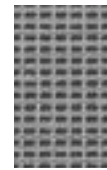

FE08



FE09

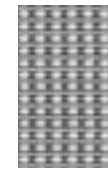

FE10

For Tagliatelle only



**POLYURETHANE TECH®**  
POLIURETANO TECH® / POLYURETHAN TECH® / POLYURÉTHANE TECH®

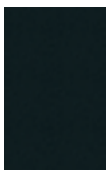

PH01

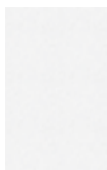

PH02

▲ Sample: available on request only  
Campione: disponibile su richiesta  
Muster: verfügbbar auf Anfrage  
Echantillon: disponible sur demande

For Elle only



**FELT**  
FELTRO / FILZ / FEUTRE



F001 F003 F004 F005 F006

▲ Sample: available on request only  
Campione: disponibile su richiesta  
Muster: verfügar auf Anfrage  
Echantillon: disponible sur demande

For Segesta / Selinunte only

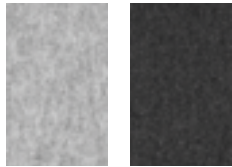
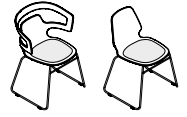

F007 F008

▲ Sample: available on request only  
Campione: disponibile su richiesta  
Muster: verfügar auf Anfrage  
Echantillon: disponible sur demande

For Aline work

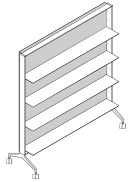

**ECO-LEATHER**  
ECOPELLE / KUNSTLEDER / SIMILI CUIR



EC01 EC02 EC03 EC04

▲ Sample: available on request only  
Campione: disponibile su richiesta  
Muster: verfügar auf Anfrage  
Echantillon: disponible sur demande

For Laleggera only



**ECO-LEATHER Serge Ferrari® Stamskin Top (A)**  
ECO PELLE / KUNSTLEDER / SIMILI CUIR

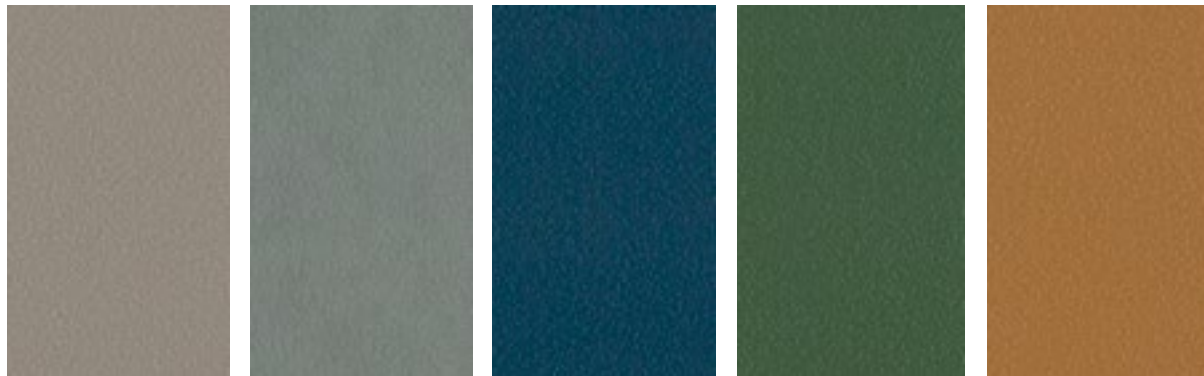

20237 07432 20284 20253 20286

Colour example eco-leather

<https://www.sergeferrari.com/productsstamskin-range/stamskin-top>

## LEATHER PENELOPE OGGI® - LANILINA

PELLE PENELOPE OGGI® -LANILINA / LEDER PENELOPE OGGI® -LANILINA / CUIR PENELOPE OGGI® -LANILINA



LA02

LA07

LA03

LA06

LA05

LA11

LA01

## PELLE FRAU® COLOR SPHERE® LEATHER

PELLE FRAU® COLOR SPHERE® / LEDER PELLE FRAU® COLOR SPHERE® / CUIR PELLE FRAU® COLOR SPHERE®



B004

B020

B026

B056

B057

B080

Colour example fabrics

## HIDE

CUOIO / KERNLEDER / CUIR SELLIER



C003

C012

C011



## OUTDOOR FABRIC Tempotest® (A)

TESSUTO PER ESTERNI Tempotest® / STOFF FÜR AUßENBEREICH Tempotest® / TISSU POUR L'EXTÉRIEUR Tempotest®



▲ Sample: available on request only  
Campione: disponibile su richiesta  
Muster: verfügbar auf Anfrage  
Echantillon: disponible sur demande

PT01

PT02

PT03

## FABRIC CAMIRA® (A)

TESSUTO CAMIRA® / STOFF CAMIRA® / TISSU CAMIRA®

URBAN

XTREME

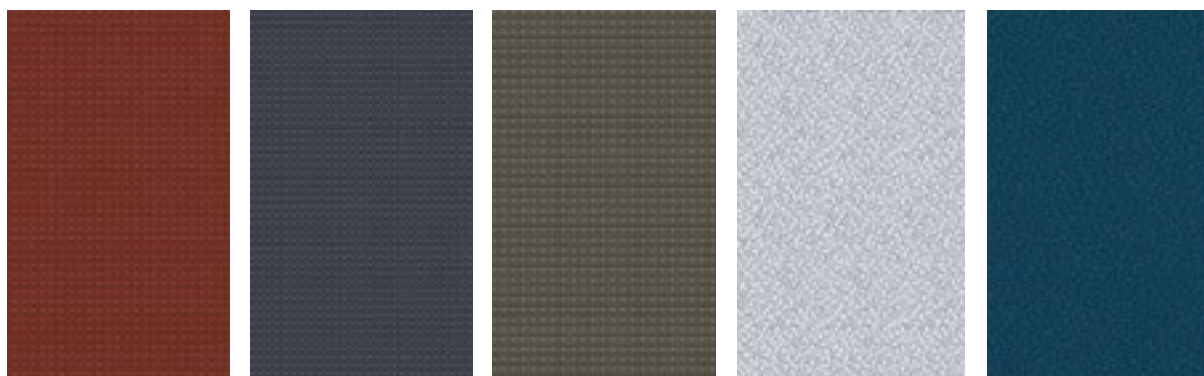

YN027

YN207

YN212

YS173

YS026

Colour example fabrics

URBAN: <https://www.camirafabrics.com/en/fabrics/contract/urban>

XTREME: <https://www.camirafabrics.com/en/fabrics/contract/xtreme>

## ALIAS FABRICS

Living I collection (A) / Collezione Living I (A) / Kollektion Living I (A) / Living I collection (A)

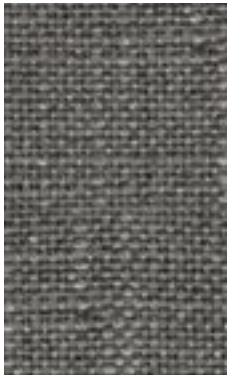

LB01



LB09



LB12



LB16



LB18

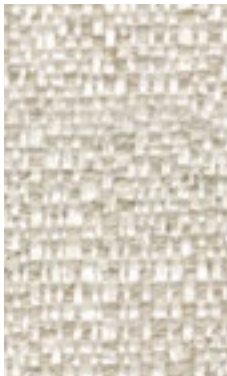

LC01

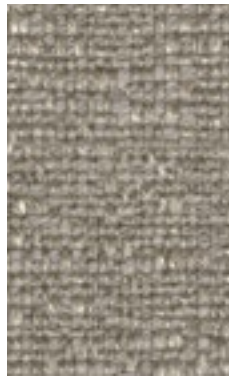

LC02



LC08



LC17



LC11

# ALIAS FABRICS

Living II collection (A) / Collezione Living II (A) / Kollektion Living II (A) / Living II collection (A)



LR02



LR04

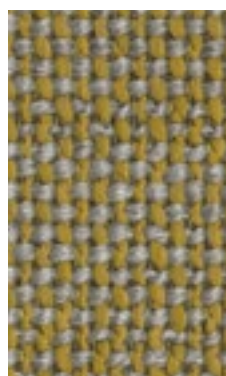

LR46

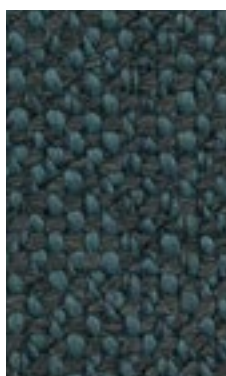

LR52

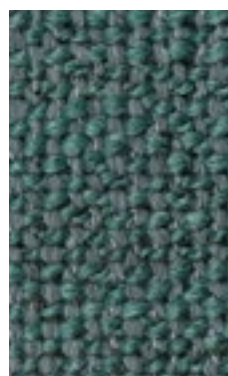

LR55



LS06

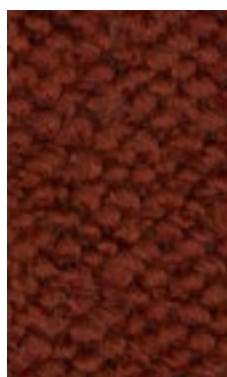

LS07

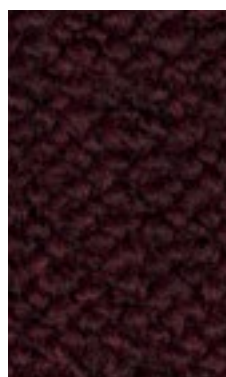

LS08

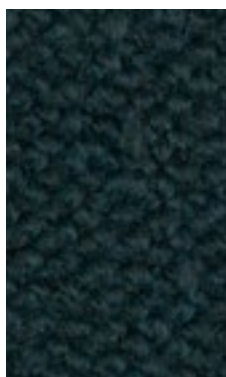

LS10

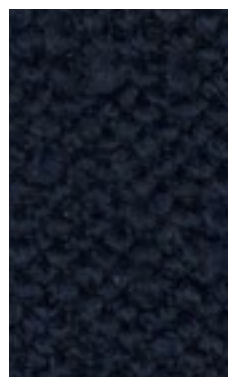

LS17



LS18



LS23

# ALIAS FABRICS

Living outdoor collection (B) / Collezione Living outdoor (B) / Kollektion Living Outdoor (B) / Living outdoor collection (B)



LN03



LN08



LN10

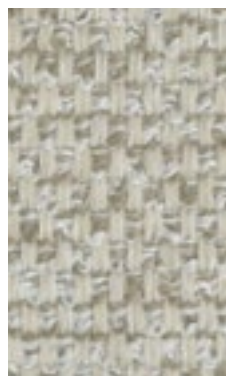

LN06



LN05

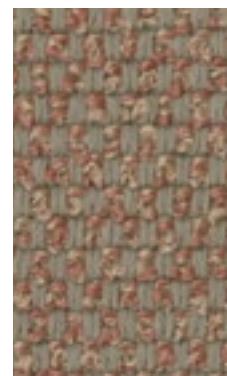

LN11



LK03



LK47

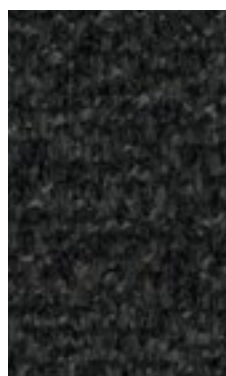

LK48



LK40

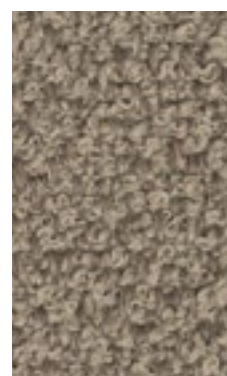

LK43

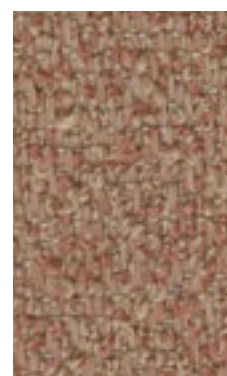

LK44

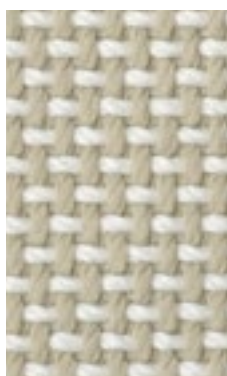

LH04

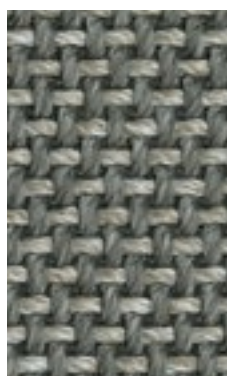

LH23



LH24

The color samples are only indicative. Due to technical limits, samples in print cannot accurately reproduce the colour characteristics of the various materials.

I colori dei campioni sono da considerarsi puramente indicativi, non essendo tecnicamente possibile riprodurre fedelmente in stampa le caratteristiche cromatiche dei vari materiali.

Die Farbmuster sind nicht verbindlich. Es ist technisch nicht möglich, die Farbeigenschaften der verschiedenen Materialien im Druck originalgetreu zu reproduzieren.

Les couleurs des échantillons sont purement indicatives, car il n'est pas techniquement possible de reproduire fidèlement en impression les caractéristiques chromatiques des différents matériaux.

# MATERIAlias

*The Vibrant Cloud*



*Earth Tones*

*Pale Ropes*

*The Vibrant*

*White*

*Native Tones*

*Dusty Greens*

*Intermediate Greys*



*Deep Browns*

*Graphite Blacks*

*Vibrant Cloud*

*Hi-Tech Tones*

*Octanium & Avio Greys*

The Vibrant Cloud is the symbolic diagram of MATERIALias, an expression of the infinite nuances of materials and colours available in the vast colour spectrum between absolute blacks and whites.

The Vibrant Cloud è il diagramma simbolico di MATERIALias, espressione di quella sfumatura infinita che materia e colore sono capaci di offrirci nell'intervallo denso che collega i bianchi e i neri assoluti degli Universi Neutri.

MAPLE

Fabric B  
Tessuto B /  
Stoff B /  
Tissu B

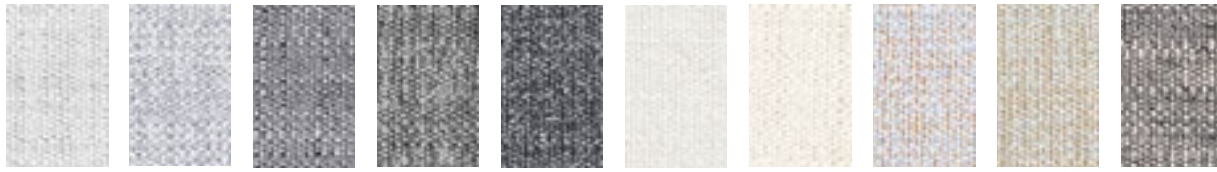

112 722 172 162 192 202 212 732 832 862

REMIX 3

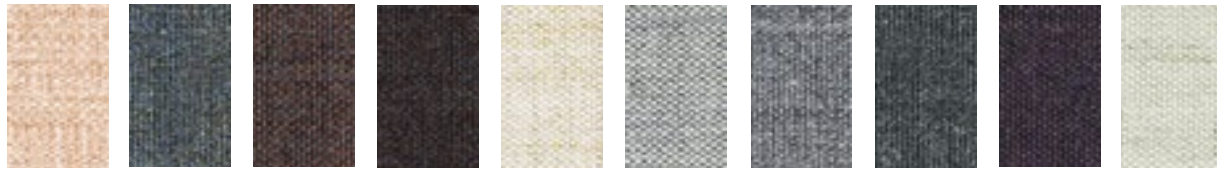

542 753 672 362 223 123 143 173 783 113

TONUS 4

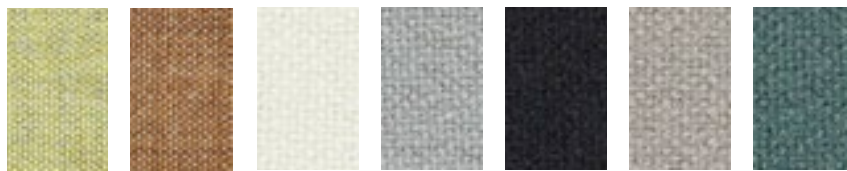

923 252 100 216 128 240 615

CANVAS 2

Fabric C  
Tessuto C /  
Stoff C /  
Tissu C

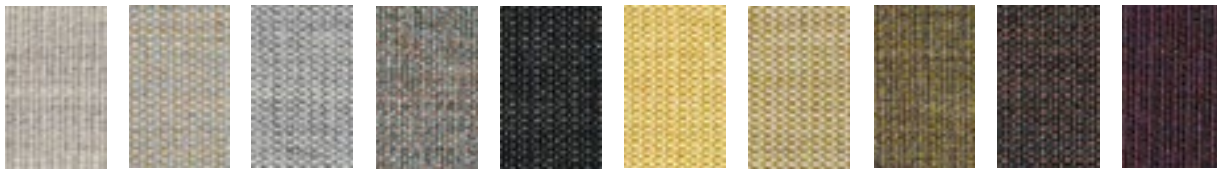

114 224 124 936 174 446 414 964 674 694

DIVINA 3

DIVINA MELANGE 3



364 154 171 181 224 376 691 793 846 120 170

FOSS

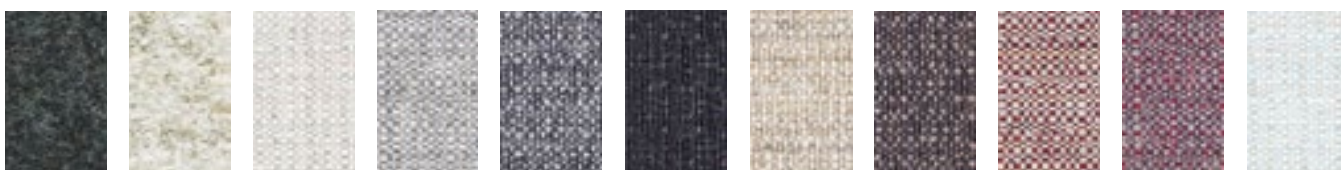

180 227 102 142 172 192 212 382 632 672 902



HALLINGDAL 65

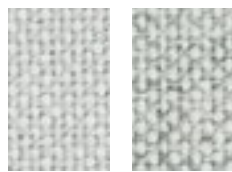

103 110



116



126



180



420



890

HARALD 3



133



143



233



242

HERO



283



443



652



823

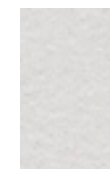

102



152



182



212



312



932



140

STEELCUT 2

STEELCUT TRIO 3



180

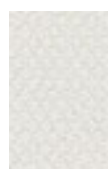

220



240



685



935



105



113

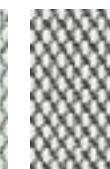

133



153



176



195

TWILL WEAVE

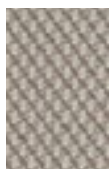

205



226



246



383



776



110



120



160



190



280

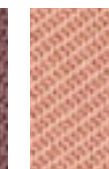

530



570



620



990

The color samples are only indicative. Due to technical limits, samples in print cannot accurately reproduce the colour characteristics of the various materials.

I colori dei campioni sono da considerarsi puramente indicativi, non essendo tecnicamente possibile riprodurre fedelmente in stampa le caratteristiche cromatiche dei vari materiali.

Die Farbmuster sind nicht verbindlich. Es ist technisch nicht möglich, die Farbeigenschaften der verschiedenen Materialien im Druck originalgetreu zu reproduzieren.

Les couleurs des échantillons sont purement indicatives, car il n'est pas techniquement possible de reproduire fidèlement en impression les caractéristiques chromatiques des différents matériaux.

**Design**  
Alias  
**Photo**  
Studio Phototecnica  
**Digital Rendering**  
Maurizio Cavallasca  
Archè Agency  
**Print in Italy**  
Grafiche Antiga  
2022

# Alias

Alias S.r.l. a Socio Unico  
via delle Marine 5  
24064 Grumello del Monte, Italy  
tel. +39 035 44 22 511  
info@alias.design  
alias.design

Each Alias product is made in Italy in accordance with a quality process meeting regulations 9001 ISO Policies have been put in place in order to minimize the environmental impact at every stage of production.

Ogni prodotto Alias viene realizzato in Italia all'interno di un processo di qualità rispondente alla norma 9001 ISO. Alias minimizza l'impatto ambientale attraverso politiche che coinvolgono ogni fase del suo operato.

Jedes Alias Produkt wird in Italien nach einem Qualitätsverfahren hergestellt, das der Norm 9001 ISO entspricht. Durch besondere Aufmerksamkeit auf jede Phase der Produktion minimiert Alias die Umweltbelastung.

Chaque produit Alias a été réalisé en Italie dans le cadre d'une procédure de qualité qui répond à la norme 9001 ISO. Alias minimise l'impact environnemental par une politique qui implique tous les stades de sa réalisation.

Certified Quality System ISO 9001



The mark of responsible forestry

Cerca i nostri prodotti certificati FSC®  
Search our FSC® certified products

follow us



Discover the Alias Catalogues





alias.design